

XP Pressure Monitor Kit

3A1331C

ENG

Monitors pressures to provide ratio assurance on XP plural-component sprayers. For professional use only. Not approved for use in explosive atmosphere locations.



Important Safety Instructions

Read all warnings and instructions in this manual and the XP sprayer operation manual. Save these instructions.

Models

262940:

Line Power Pressure Monitor Kit with Light Tower

262942:

Air Turbine Power Pressure Monitor Kit with Light Tower

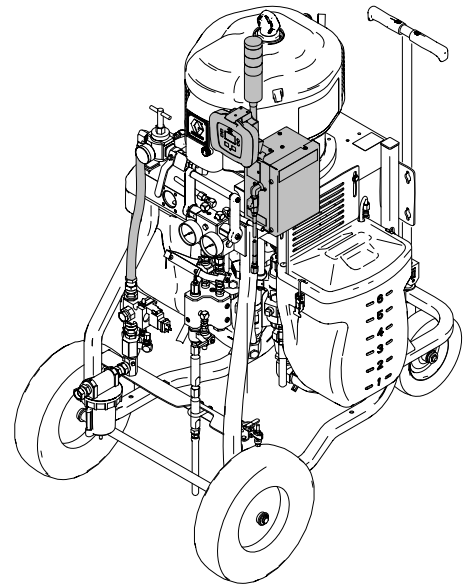

Contents

Overview.....	3	Replace Filter Element.....	16
Operating Window	3	Replace Alternator or Turbine Cartridge.....	17
Component Identification.....	4	Parts.....	18
262940 Line Power Kit	4	Appendix A— User Interface Display	22
262942 Air Turbine Kit.....	5	Setup Mode Details.....	22
User Interface	6	Changing Setup Parameters	22
Display Components	7	Setup Screen 1	22
Installation.....	8	Setup Screen 2	23
Location	8	Setup Screen 3	24
Install Air Solenoid	8	Set Password.....	24
Install Electronics Box and LCM.....	9	Run Mode Details	25
Install Pressure Transducers	9	Circulation Mode Active	25
Connect Air Hoses and Cables	10	Spray Mode Active	25
Startup.....	10	Alarm Active	25
Shutdown.....	10	Deviation Active	26
Advisories and Alarms	11	Information Screen.....	26
Clear Alarms.....	11	Appendix B - Breakout Module	
View Current Alarms	11	Connections.....	27
View Error Log.....	12	Accessories.....	28
Error Codes.....	13	Technical Data	29
Repair.....	16	Graco Standard Warranty.....	30
Replace LCM Tear Off Sheet.....	16		
Replace Switch Fuses.....	16		

Overview

Topics Covered in this Chapter

◆ Operating Window

The purpose of the pressure monitor kit is to shutdown the sprayer if abnormal pressure conditions are detected to prevent spraying material that is not mixed on ratio.

Two pressure transducers are added to read the A and B fluid pressures in the outlet manifold and send the readings back to the Local Control Module (LCM).

The control watches the difference between the A and B pressures. The control will alarm if the pressures split because of a plug, leak, or running out of fluid.

When an alarm indicates that the sprayer may be off ratio, the air solenoid shuts off the air supply to the proportioner motor. The light tower will indicate an alarm has occurred, and the alarm code will be on the LCM display. For more information see Advisories and Alarms, page 11.

The following alarms can occur:

- Differential Pressure (B>A)
- Differential Pressure (A>B)
- Pressure A High
- Pressure B High
- Air Solenoid Disconnected
- Pressure A Disconnected
- Pressure B Disconnected

Operating Window

Below Minimum Spray Pressure

The air motor is allowed to automatically operate in Circulation Mode with a yellow light anytime the fluid pressures are below the minimum spray pressure. This allows for loading the system and circulating the fluids without alarms or shutdowns.

Above Minimum Spray Pressure

When the control sees the fluid pressures above the minimum spray pressure for 3–30 seconds, and the pressures are balanced within the pre-set limits, it will automatically start the monitor mode, and the green light on the light tower will change to solid on. If the control does not see balanced pressures within 30 seconds of going above the minimum spray pressure, it will alarm and shut off the air motor. The default minimum spray pressure is 2000 psi (14 MPa, 138 bar). Enter Setup Mode to change the minimum spray pressure as necessary.

Maximum Spray Pressure

The control will alarm and shutdown if it sees either A or B above the maximum working pressure of 7250 psi (50 MPa, 500 bar). Enter Setup Mode to reduce the maximum allowable pressure set point.

Component Identification

Topics Covered in this Chapter

- ◆ 262940 Line Power Kit
- ◆ 262942 Air Turbine Kit
- ◆ User Interface

262940 Line Power Kit

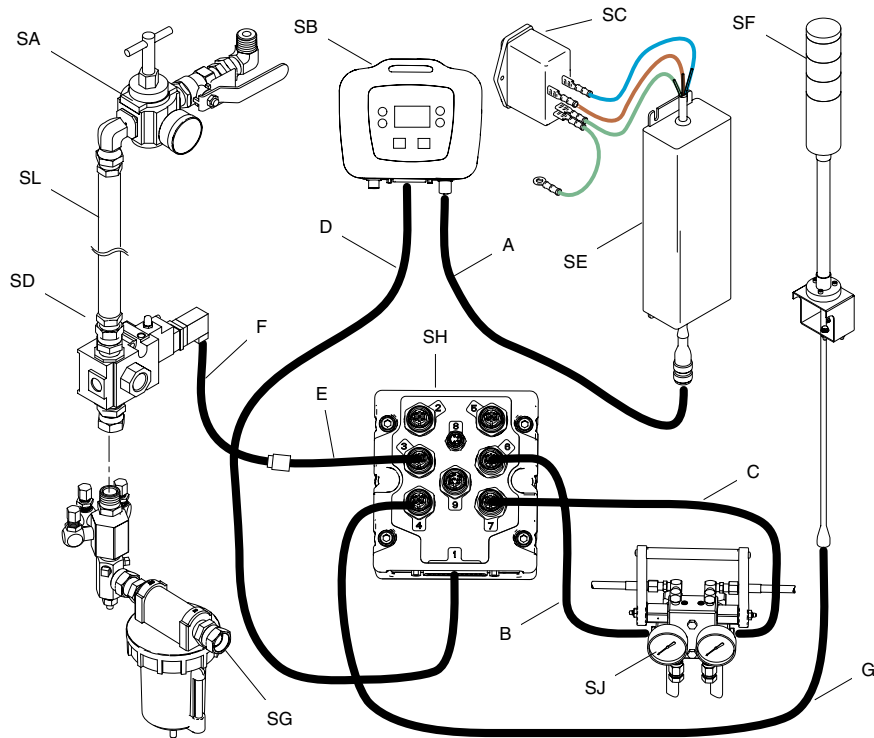

Figure 1

Table .2 System Component Identification Table

Table .1 Cable Identification Table

Ref.	Cable	Identification Label
A	Power Supply	CAN
B	A Pressure Transducer	6-Blue
C	B Pressure Transducer	7-Red
D	LCM Cable	1-Blue
E	Solenoid Extension Cable	3-Red
F	Solenoid Cable	3-Red
G	Light Tower	4-Green

Ref.	System Component
SA	XP Motor Air Controls (reference)
SB	Local Control Module (LCM)
SC	Power Entry Fuses and Switch
SD	Motor Air Solenoid Valve, 24 Volt
SE	Power Supply, 24 Volt
SF	Light Tower, 24 Volt
SG	XP Air Inlet Assembly (reference)
SH	Breakout Module
SJ	XP Fluid Manifold (reference)
SL	Motor Air Hose

262942 Air Turbine Kit

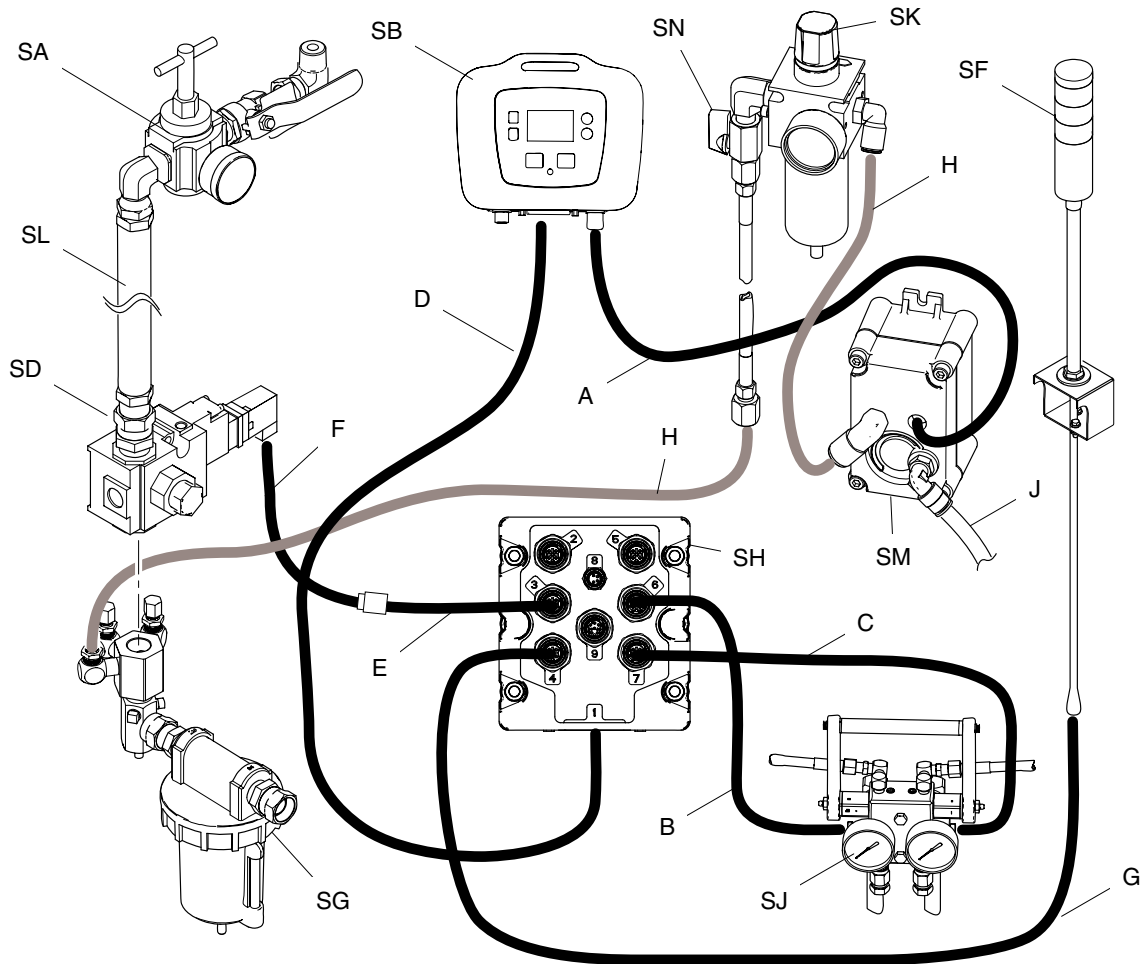

Figure 2

Table .4 System Component Identification Table

Table .3 Cable Identification Table

Ref.	Cable	Identification Label
A	Power Supply	CAN
B	A Pressure Transducer	6-Blue
C	B Pressure Transducer	7-Red
D	LCM Cable	1-Blue
E	Solenoid Extension Cable	3-Red
F	Solenoid Cable	3-Red
G	Light Tower	4-Green
H	Air Tubing	—
J	Air Exhaust	—

Ref.	System Component
SA	XP Motor Air Controls (reference)
SB	Local Control Module (LCM)
SD	Motor Air Solenoid Valve, 12 Volt
SF	Light Tower, 12 Volt
SG	XP Air Inlet Assembly (reference)
SH	Breakout Module
SJ	XP Fluid Manifold (reference)
SK	Turbine Air Regulator
SL	Motor Air Hose
SM	Air Powered Alternator, 12 Volt
SN	Alternator Power Shutoff Valve

User Interface







Figure 3

NOTICE

To prevent damage to soft key buttons, do not press the buttons with sharp objects such as pens, plastic cards, or fingernails.

Table .5 LCM Button Functions

Button	Function
Mode 	Select between Run and Setup Modes.
Spray 	Start and stop the air motor. The motor will stay on indefinitely if pressures are below minimum spray pressure. Monitor mode will start within 30 seconds if the pressures are above the minimum spray pressure and no errors exist. All errors are ignored for up to the first 30 seconds. Default is 2000 psi (138 MPa, 138 bar)
Arrows Up/Down 	Navigate up or down within a screen or to a new screen.
Soft Keys 	Soft keys activate the mode or action represented by the icon next to each soft key. See Table 2 for soft key icons and actions. Top Soft Key: Edit data, accept edited data, or move right within a number field. Bottom Soft Key: Enter a screen, exit a screen, or cancel edited data.

Display Components

The following tables identify components shown on the spray mode active, circulation mode active, alarm active, and deviation active run screens. For more information see Run Mode Details, page 25.

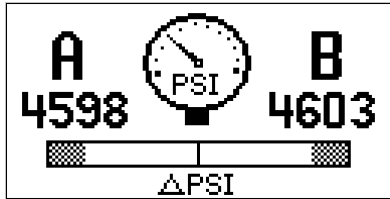

Spray Mode Active Screen
Figure 4

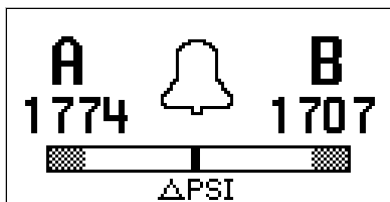

Circulation Mode Active Screen
Figure 5

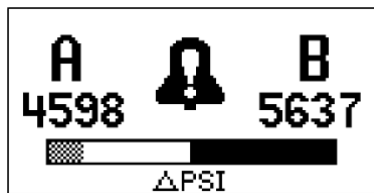

Alarm Active Screen
Figure 6

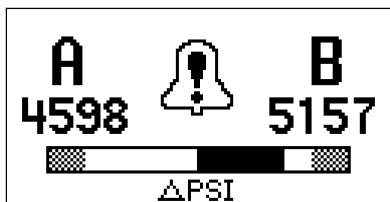

Deviation Active Screen
Figure 7

Table .6 Display Components

Icon	Function
A B	Actual spray pressures
	Differential pressure alarm bar graph
	Selected pressure units. Indicates that you are in spray mode.
	Indicates that you are in circulation mode.
	Indicates that there is an active alarm.
	Indicates that there is an active deviation.

Table .7 Display Soft Key Icons

Icon	Function
Enter Screen 	In screens that have editable fields, press to access the fields and make changes.
Exit Screen 	In screens that have editable fields, press to exit edit mode.
Enter 	In screens that have editable fields, press to make data selections or to enter changes.
Right 	In screens that have editable fields, press to move to the right while in a field.
Cancel 	Cancel a selection or edited data. Returns to the original data.
Clear Error Log 	Clear entire error log..

Installation

Topics Covered in this Chapter

- ◆ Location
- ◆ Install Air Solenoid
- ◆ Install Electronics Box and LCM
- ◆ Install Pressure Transducers
- ◆ Connect Air Hoses and Cables

Shutdown the XP Sprayer before installing your pressure monitor kit. Follow the Shutdown and Pressure Relief Procedure in the XP Sprayer operation manual. All electrical wiring must be done by a qualified electrician and comply with all local codes and regulations.

The procedures in this section are specific to each component of the pressure monitor kit. For sprayer installation instructions, refer to the XP70 Sprayer Operation manual.

Location

These pressure monitoring kits are not approved for use in hazardous atmosphere locations. Installing this kit on a XP Sprayer that is EX approved, voids the approval. The EX mark should be removed from the machine ID plate when this kit is installed.

NOTICE

Do not store a XP Sprayer with a pressure monitor kit outside in the rain. Use protective bag 16J717 to prevent damage to the electronic components, used with the pressure monitor kit, when stored outside.

Install Air Solenoid

1. Disconnect the upper swivel and remove the motor air line from the lower air manifold.

Note

On early XP sprayers, to remove the existing air hose, it may be necessary to remove the air filter assembly from the XP and put it in a vice. New models XP sprayers have an additional hose union.

2. For the turbine powered kit 262942, remove a plug from the air manifold and install the 5/16 in. x 4 ft (1.2 m) air hose.

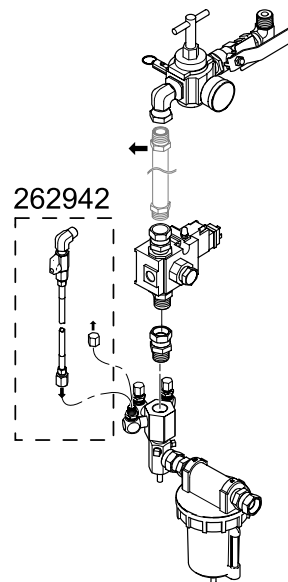

Figure 8

3. Connect the air solenoid valve and new motor air hose to the air inlet assembly. Ensure that the air solenoid valve cable faces the back of the machine.

Install Electronics Box and LCM

Early XP carts have two mounting holes and new XP carts have three mounting holes. Complete steps 1 and 2 to drill a third mounting hole for the pressure monitor kit. Complete step 2 if you have a new XP cart.

1. **Early XP carts with two mounting holes**
 - a. Use two screws (61) and two nuts (62) to mount the electronics box to the top of the cart.
 - b. Use a marker to mark the bracket's third mounting hole.
 - c. Loosen the nuts (62) below the cart shelf and remove the screws (61), and box bracket. Center punch and drill a 5/16 in. hole in the top of the cart.
2. **New XP carts with three mounting holes.**
 - a. Use three screws (61) and three nuts (62) to mount the box bracket to the cart.
 - b. For power supply kits, install the appropriate power supply cord(s). US, European, and Australia/Asia cord adapters are supplied. See Technical Data, page 29.

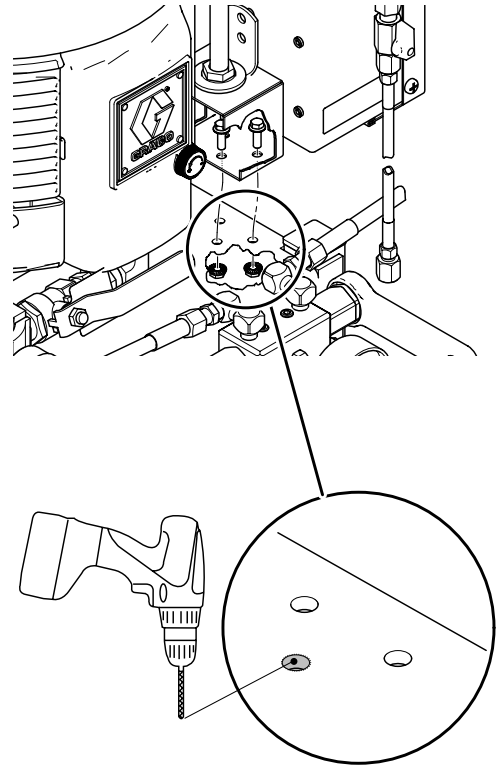

Early XP Cart Installation
Figure 9

Install Pressure Transducers

1. Remove plugs from the circulation manifold.
Note
Keep plugs if you will ever remove the pressure monitor kit.
2. Connect pressure transducer (4), with blue #6 label, with black o-ring (13) to the A side of the circulation manifold. Connect pressure transducer (4), with red #7 label, with black o-ring (13) to the B side of the circulation manifold. Tighten to 40–50 ft-lb (54–67 N•m) before applying fluid pressure.

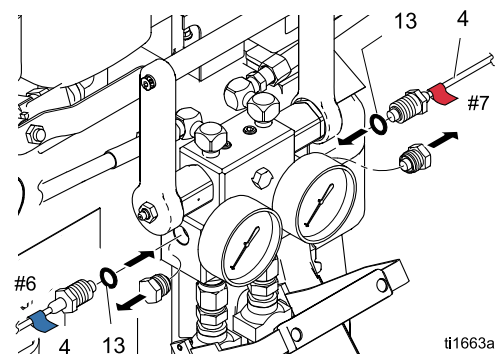

Pressure Transducers
Figure 10

Connect Air Hoses and Cables

Reference 262940 Line Power Kit, page 4 and 262942 Air Turbine Kit, page 5 for air hose and cable connections.

Use tie wraps provided to secure hose and cables. For turbine kit 262942, route exhaust hose down cart leg and secure.

- 262942: Secure solenoid cable (F) to air hoses with tie wrap. Route exhaust hose (J) down the inside of the cart leg and secure with tie wrap.
- 262940: Route solenoid cable (F) behind the air hose and secure with tie wrap.

Startup

1. Refer to your XP Sprayer Operation manual for sprayer startup instructions.

Note

The pressure monitor kit modifies XP sprayers. However, the operation procedures from the XP sprayer Operation manual still apply.

2. Turn on power.
 - a. For 262940: Turn on power switch (9) located on the electronics box.
 - b. For 262942: Open ball valve (22) located outside of the electronics box.
3. Wait for the power up screen to complete. The Circulation Mode screen will display. The light tower will briefly flash green, yellow, and red to verify the lights before staying on yellow. Wait for the run screen to appear.
4. Set system parameters before spraying. These can be changed as necessary.

Press  to enter Setup Mode. For

more information and default settings, see Setup Mode Details, page 22.

5. In Circulation Mode, all alarms are disabled except for the air solenoid detection, pressure sensor failure, and high pressure alarms.

Note

In Manual Bypass Mode you can still spray when one pressure transducer fails, but the control no longer monitors the pressures and will not shut off the sprayer. This is for emergency only.

- a. To enter Manual Bypass Mode, set the minimum spray pressure equal to the maximum spray pressure on setup screen 2. In Manual Bypass Mode, the system can never get into Spray Mode. The event code EVC1 is displayed on the information screen and logged in the error log. The yellow light is always on and all alarms are ignored.
- b. To exit Manual Bypass Mode, set the minimum spray pressure and maximum spray pressure to different spray pressures. Event code EVC0 will log in the error log when Bypass Mode is disabled.

6. Press  to start the air motor. The red LED will turn on and the motor will start. Only spray when the green light on the light tower is on. For more information about the LCM run screens, see Run Mode Details, page 25.

Shutdown

1. Press . The red LED will turn off and the motor will stop.
2. Turn off the power switch or ball valve on the outside of the electronics box.

Advisories and Alarms



Topics Covered in this Chapter

- ◆ Clear Alarms
- ◆ View Current Alarms
- ◆ View Error Log
- ◆ Error Codes

There are three types of errors that can occur. Errors are indicated by the light tower as well as on the display.



Alarms indicated by , require immediate attention; therefore, the control disables the air motor and the Information screen automatically displays.

Deviations, indicated by , require attention, but not immediately.

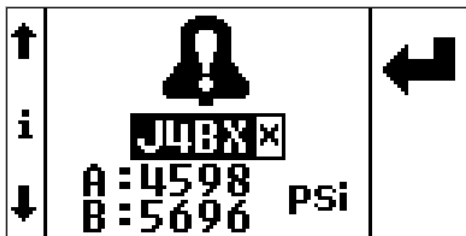
Advisories, indicated by , do not require attention. Therefore, if a deviation or advisory occur, the system continues running and  or  displays next to the operation mode field.



The following table explains the error type that is associated with the particular light tower LED.

Light Tower LED	Description
Green Solid	System is powered up and monitoring pressure.
Yellow Solid	In Circulation Mode or Manual Bypass Mode 
Yellow Flashing	A deviation exists 
Red Solid	An alarm exists and the system shuts down 

Clear Alarms

For more information about the alarms, see Information Screen, page 26.

To clear an error:

1. Press  to clear the alarm.
2. Press  to restart the air motor.

View Current Alarms



From the Run screen, press   to navigate to the Information screen. The Information screen displays current alarms or advisories.



Figure 11

View Error Log

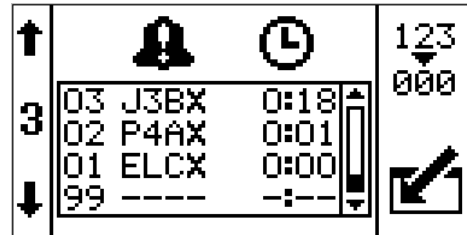

Setup Screen 3 is the error log screen. It displays the most recent error on the top of the list with the past three errors below it. This screen displays a list of advisory or alarm error codes and the time the error occurred since the kit was powered on.







The screenshot shows a screen with a grid layout. On the left side, there is a vertical column containing an upward arrow, the number '3', and a downward arrow. The main area is a table with three columns: error code, error name, and time. The table contains four rows of data. To the right of the table, there are two rows of numbers: '123' and '000'. At the top right, there are two icons: a bell and a clock. At the bottom right, there is a checkmark icon.





Error Code	Error Name	Time
03	J3BX	0:18
02	P4AX	0:01
01	ELCX	0:00
99	----	-:-

Error Codes

Code	Icon	Code Name	Light Tower Code	Cause	Solution
Alarms					
J4AX		Differential Pressure (A>B)	Red Solid	Ran out of B side material.	Refill hopper or change drum.
				Cavitating B side pump.	Warm material or add feed pressure.
				B material leaking.	Follow pump troubleshooting in XP70 Sprayer manual.
				No mix manifold B side restriction.	Add restriction to B side on mix manifold to balance pressures.
				A side hose is too small.	Change to larger hose size.
				Improper configuration.	Adjust setpoints on setup screens. See Setup Mode Details, page 22.
J4BX		Differential Pressure (B>A)	Red Solid	Ran out of A side material.	Refill hopper or change drum.
				Cavitating A side pump.	Warm material or add feed pressure.
				A material leaking.	Follow pump troubleshooting in XP70 Sprayer manual.
				Too much restriction on mix manifold B side restriction.	Reduce restriction to B side on mix manifold.
				* B side hose is too small.	Change to larger diameter hose size.
				* No B side offset in control setup.	Adjust B side offset in setup screens if B normally runs at a higher pressure than A. See Setup Mode Details, page 22.
				Improper configuration.	Adjust setpoints on setup screens. See Setup Mode Details, page 22.
P6AX		Pressure A Disconnected	Red Solid	Broken cable.	Replace transducer.
				Disconnected cable.	Connect cable.

Code	Icon	Code Name	Light Tower Code	Cause	Solution
Alarms					
P6BX		Pressure B Disconnected	Red Solid	Broken cable.	Replace transducer.
				Disconnected cable.	Connect cable.
WJPX		Air Solenoid Disconnected	Red Solid	Broken cable.	Replace cable.
				Disconnected cable.	Connect cable.
				Damaged solenoid.	Replace solenoid.
P4AX		Pressure A High	Red Solid	A pressure exceeded maximum working pressure set point.	Reduce air pressure to motor or adjust setpoint.
P4BX		Pressure B High	Red Solid	A pressure exceeded maximum working pressure set point.	Reduce air pressure to motor or adjust setpoint.
					Open down stream valve.
				Blockage in B line downstream.	Reduce downstream restriction.
					Clean mix manifold.

* Remote mix manifold applications only.

Code	Icon	Code Name	Light Tower Code	Cause	Solution
Deviations					
J3AX		Differential Pressure (A>B)	Yellow Flashing	Ran out of B side material.	Refill hopper or change drum.
				Cavitating B side pump.	Warm material or add feed pressure.
				B material leaking.	Follow pump troubleshooting in XP70 Sprayer manual.
				No mix manifold B side restriction.	Add restriction to B side on mix manifold to balance pressures.
				A side hose is too small.	Change to larger hose size.
J3BX		Differential Pressure (B>A)	Yellow Flashing	Ran out of A side material.	Refill hopper or change drum.
				Cavitating A side pump.	Warm material or add feed pressure.
				A material leaking.	Follow pump troubleshooting in XP70 Sprayer manual.
				Too much restriction on mix manifold B side restriction.	Reduce restriction to GB side on mix manifold.
				* B side hose too small.	Change to larger hose size.
				* No B side offset in control setup.	Add B side offset in setup screen.
Events and Advisories					
EERX		Under Minimum Spray Pressure, Circulation, Loading	Yellow	Under minimum spray pressure.	Normal for circulation mode.
EVC0		Manual Bypass Mode Enabled and Logged. Minimum Pressure = Maximum Pressure	Yellow	Manual Bypass Mode	Reset minimum spray pressure and maximum spray pressure in Setup Mode.
EVC1	—	Manual Bypass Mode Disabled and Logged	—	Event log only	—
ELCX	—	Control Power Up Timer set to zero in Log	—	Event log only	—

* Remote mix manifold applications only.

Repair

Topics Covered in this Chapter

- ◆ Replace LCM Tear Off Sheet
- ◆ Replace Switch Fuses
- ◆ Replace Filter Element
- ◆ Replace Alternator or Turbine Cartridge

For system specific repair procedures, refer to your XP Sprayer instructions-parts manual.

Replace LCM Tear Off Sheet

The LCM is supplied with 10 protective tear off sheets that prevent spray material from covering the LCM display.

1. Peel away the dirty protective sheet.
2. Install a new protective sheet (68) on the LCM display.

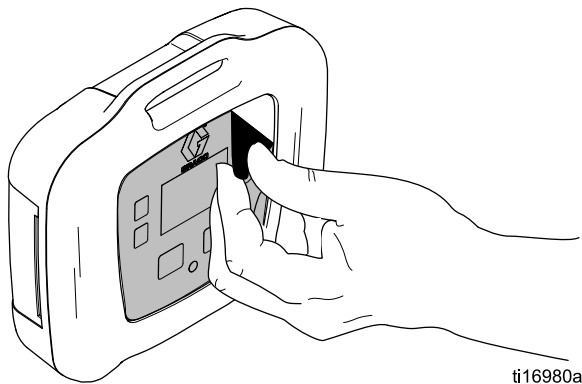

Figure 12

ti16980a

Replace Switch Fuses

For 262940 only.

1. Remove power inlet cord (55 or 57).
2. Pry off small plastic cover above cord inlet.
3. Pull fuses (63) out of power switch. Replace and reassemble.

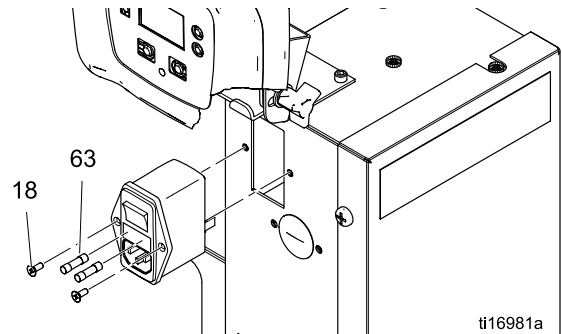

Figure 13

ti16981a

Replace Filter Element

There is a 5 micron air filter used with the regulator on the alternator power kit 262942. Check the filter monthly and replace element as needed.

1. Close main air shutoff valve on air supply line and on unit. Depressurize air line.
2. Remove box cover (30).
3. Press silver tab in, twist bowl to the left, and pull down off of the regulator.
4. Remove and replace element.
5. Screw filter bowl on securely until the tab clicks.

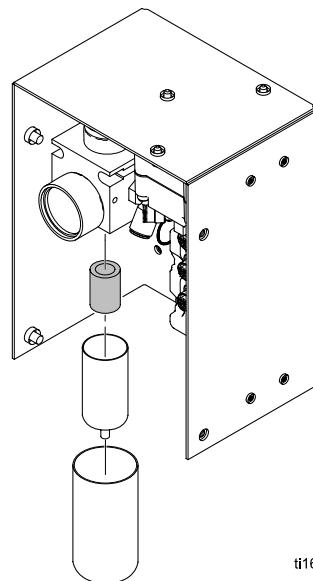

Figure 14

ti16985a

Replace Alternator or Turbine Cartridge

For 262942 only.

Turbine alternator cartridge 257147 (34e) can be replaced in alternator 262579 (34).

1. Turn off air supply.
2. Close ball valve (22).
3. Remove box cover (30).

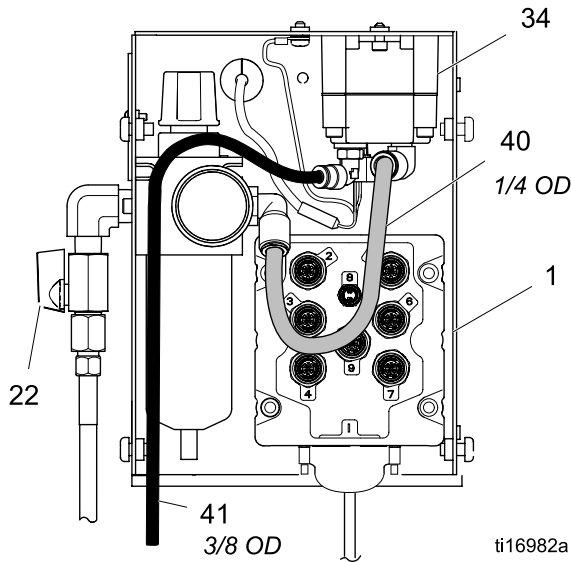

Figure 15

4. Disconnect the alternator power supply cable (A) from the LCM (21). Disconnect ground wire (Z).
5. Disconnect air tube (40) from the alternator (34).
6. Remove two screws (15) to remove alternator from the box (1).
7. Remove four screws (34d) to separate alternator housings.
8. Disconnect turbine cartridge ribbon connector (34e) from board (AB).
9. Replace gasket (34a) if damaged. Place between housings before securing with screws (34d).

10. Reassemble.

Note

- Lightly lubricate turbine o-ring before installing turbine in housing.
- Align ribbon connector and firmly press the cartridge into the top housing.
- Connect turbine to 3-pin connector on main circuit board.
- Torque housing screws evenly to 18 in.-lbs (2 N•m).
- Reassemble into control box (1).

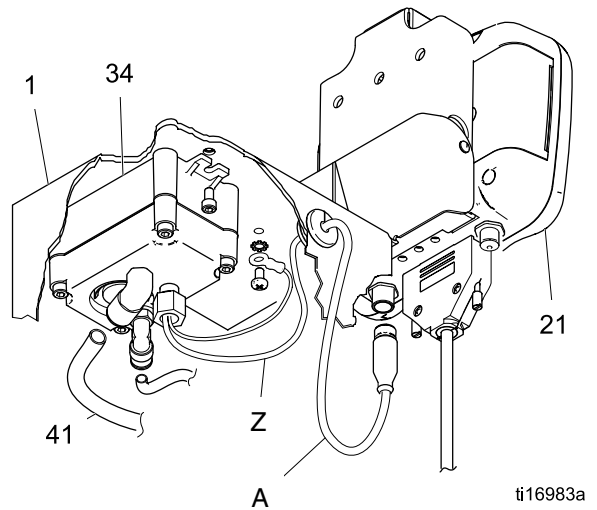

Figure 16

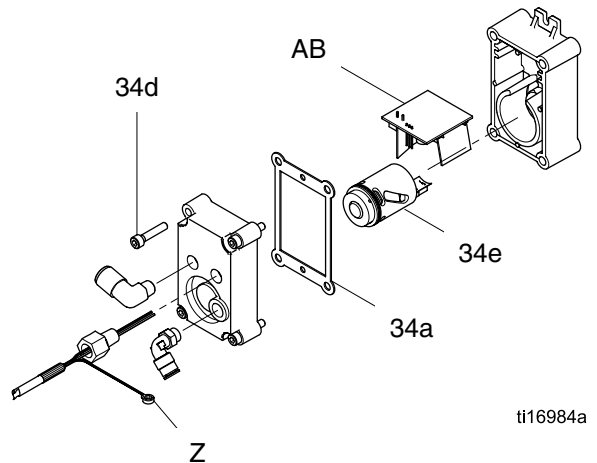
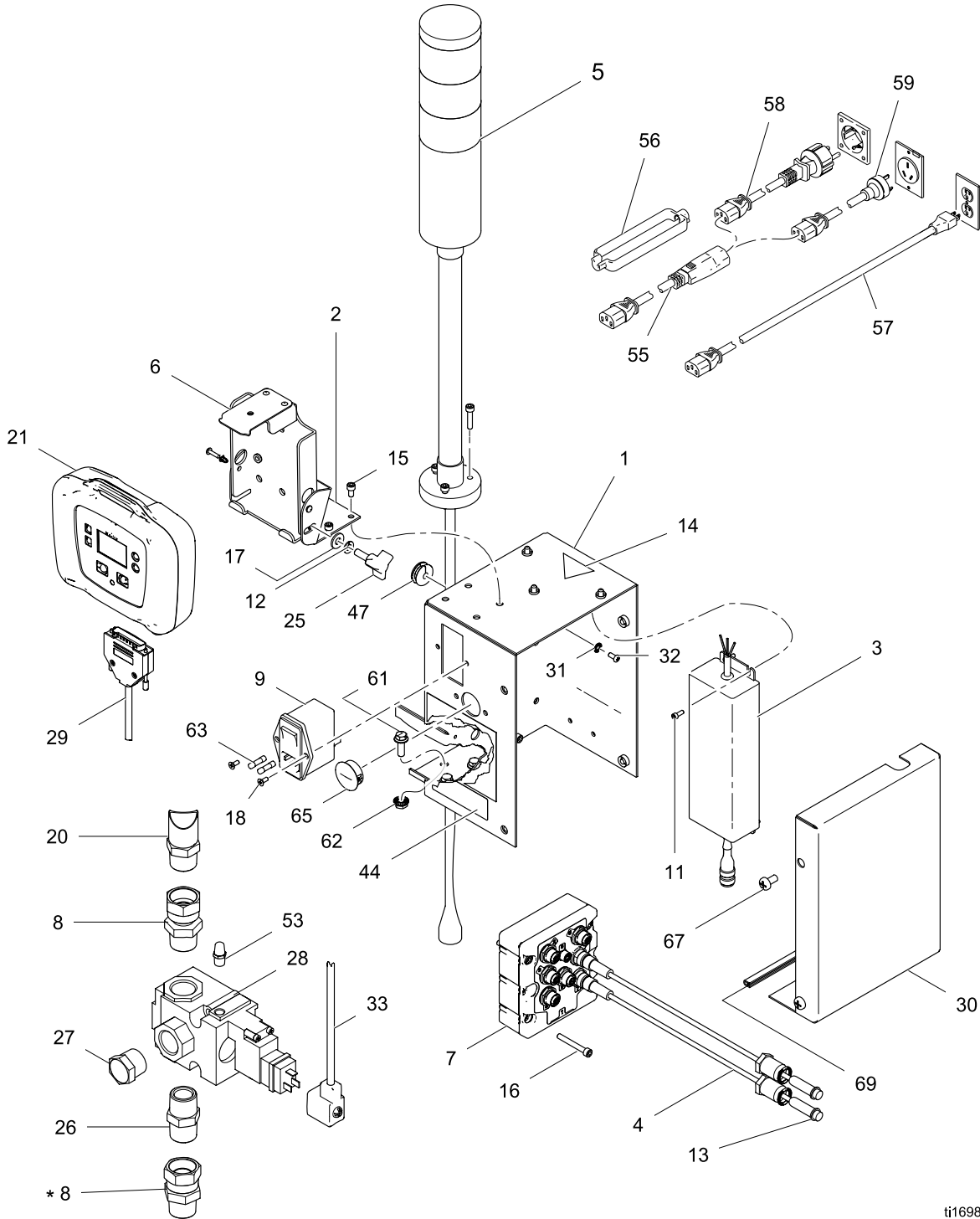

Figure 17

Parts

262940 Line Power Pressure Monitor Kit



ti16986a

Apply sealant to all non-swiveling pipe threads.

* Already included on new XP model sprayers.

Ref.	Part	Description	Qty.	Ref.	Part	Description	Qty.
1	262457	BOX, weldment assembly	1	29	15T859	CABLE, assembly, DB25, 10 ft (3 m)	1
2	—	BRACKET, top mount	1	30	—	COVER, box	1
3	15M293	POWER SUPPLY, 24VDC, 2.5A, 60W, gnd wire	1	31	102063	WASHER, lock, ext	1
4	15M669	SENSOR, pressure, fluid outlet	2	32	108865	SCREW, cap, button hd	1
5	15X472	LIGHT TOWER, m12	1	33	121806	CABLE, solenoid	1
6	—	BRACKET, mounting	1	43	122030	CABLE, GCA, M12-5P	1
7	258999	MODULE, LCM, breakout	1	47	16H323	GROMMET, one slit	1
8	157785	SWIVEL	2	53	120206	MUFFLER, sintered, dia 1/8	1
9	121254	SWITCH, power, 120V	1	55	116281	CORD SET, IEC320(M-F), 6 ft (1.8 m)	1
11	102410	SCREW, cap, sch	4	56	195551	RETAINER, plug, adapter	1
12	100016	WASHER, lock	1	57	245202	CORD, SET, USA, 10 ft (3 m), 13 AMP, 120V	1
13	121399	O-RING 012, solvent resistant	2	58	242001	CORD SET, adapter, Europe; 8 in. (20 mm)	1
14▲	189930	LABEL, caution	1	59	242005	CORD SET, adapter, Australia-Asia; 8 in. (20 mm)	1
15	104371	SCREW, cap sch 10X.375	4	61	113796	SCREW, flanged, hex hd	3
16	104472	SCREW, cap; 10–32 x 1.5	4	62	115942	NUT, hex, flange head	3
17	110755	WASHER, plain	1	63	121261	FUSE, 250V / 1.2A	2
18	—	SCREW, countersunk, 6-32 x .38	2	65	114606	PLUG, hole	1
20	110047	HOSE, coupled, 18 in. (457.2 mm)	1	67	113783	SCREW, 1/4–20, pn hd	4
21	24H286	MODULE, LCM; includes 21a and instructions	1	68	16H378	SHIELD, membrane, LCM (pack of 10)	1
21a	16G728	TOKEN, PM software; not shown	1	69	114225	TRIM, edge protection; 0.6 ft (0.18 m)	1
21b◆	—	MODULE, LCM	1	70	16J685	LABEL, error codes	1
25	121253	KNOB, display adjustment	1	▲ Replacement Danger and Warning labels, tags, and cards are available at no cost.			
26	119992	NIPPLE, 3/4 x 3/4 npt	1	◆ Base electronic components do not have Pressure Monitor specific software installed. Therefore, use software upgrade token (21a) to install software before use.			
27	111530	MUFFLER	1				
28	16G901	VALVE, 24VDC, internal pilot, 3/4	1				

262942 Air Turbine Pressure Monitor Kit

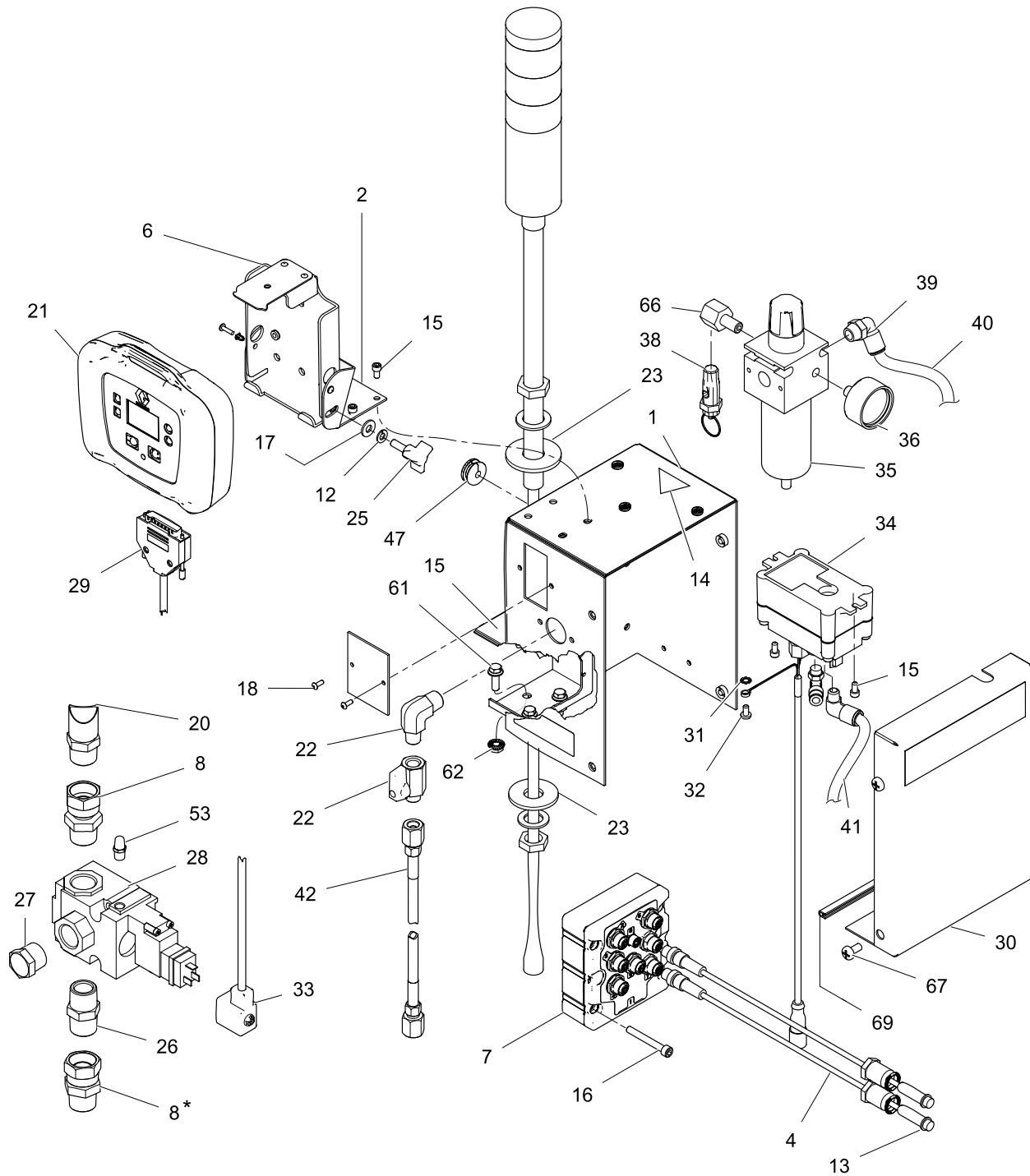

ti16987a

Apply sealant to all non-swiveling pipe threads.

* Already included on new XP model sprayers.

Ref.	Part	Description	Qty.	Ref.	Part	Description	Qty.
1	262457	BOX, assembly	1	33	121806	CABLE, solenoid	1
2	—	BRACKET, top mount	1	34	262579	MODULE, alternator, M12, non-IS	1
4	15M669	SENSOR, pressure, fluid outlet	2	34a	193154	GASKET, alternator	1
5	16H600	LIGHT, tower, M12, 12VDC	1	34e	257147	CARTRIDGE, alternator	1
6	—	BRACKET, mounting	1	35	119644	FILTER REGULATOR, 3/8 npt (auto drain)	1
7	258999	MODULE, LCM, breakout	1	35a	11228	ELEMENT, filter, 5 micron	1
8	157785	FITTING, swivel; 3/4 mxf	2	36	108190	GAUGE, pressure, air	1
12	100016	WASHER, lock; 1/4	1	37	121858	ELBOW ,3/8 nptm x 1/4 nptm	1
13	121399	O-RING 012, solvent resistant	2	38	125385	VALVE, safety, regulator	1
14▲	189930	LABEL, caution	1	39	114153	ELBOW, male, swivel	1
15	104371	SCREW, cap sch 10 x 0.375	9	40	054175	TUBE, nylon, rd; 1/4, 0.6 ft (0.18 m)	1
16	104472	SCREW, cap; 10–32 x 1.5	4	41	C12508	TUBING, nylon, round; 3/8, 4 ft (1.2 m)	1
17	110755	WASHER, plain	1	42	248208	HOSE, coupled ,6 ft (1.8 m), 1/4 npsm, 5/16	1
18	108026	SCREW, cap, hex, button hd; 6–32 x 3/8	2	43	122030	CABLE, M12-5P m x f; 20 in. (508 mm)	1
20	110047	HOSE, coupled, 3/4 npt x 18 in. (457.2 mm)	1	47	16H323	GROMMET, one slit	1
21	24H286	MODULE, LCM; includes 21a and instructions	1	53	120206	MUFFLER, sintered, dia 1/8	1
21a	16G728	TOKEN, PM software; not shown	1	61	113796	SCREW, flanged, hex hd; 1/4–20	3
21b◆	—	MODULE, LCM	1	62	115942	NUT, hex, flange head; 1/4–20	3
22	15B565	VALVE, ball	1	66	158962	ELBOW, st pipe, rdcg	1
23	114314	WASHER, plain	2	67	113783	SCREW, 1/4–20, pn hd	4
24▲	172953	LABEL, ground	1	68	16H378	SHIELD, membrane, LCM (pack of 10)	1
25	121253	KNOB, display adjustment	1	69	114225	TRIM, edge protection; 0.6 ft (0.18 m)	1
26	119992	NIPPLE, 3/4 x 3/4 npt	1	70	16J685	LABEL, error codes	1
27	111530	MUFFLER	1				
28	16H550	VALVE, 12VDC, internal pilot, 3/4	1				
29	15T859	CABLE, assembly, DB25, 10 ft (3 m)	1				
30	—	COVER, box	1				
31	C38163	WASHER, lock, ext. tooth	1				
32	103833	SCREW, machined, crbh	1				

▲ Replacement Danger and Warning labels, tags, and cards are available at no cost.

◆ Base electronic components do not have Pressure Monitor specific software installed. Therefore, use software upgrade token (21a) to install software before use.

Appendix A— User Interface Display

Topics Covered in this Chapter









- ◆ Setup Mode Details
- ◆ Run Mode Details
- ◆ Information Screen

Setup Mode Details

Setup mode screens enable user to view or modify system configuration data. User can set:

- Units of pressure
- Differential pressure warning value
- Differential pressure alarm value
- High pressure limit value
- Minimum spray pressure value
- Normal B pressure offset value



Changing Setup Parameters

1. Navigate to a Setup screen by pressing . Then use   to select a screen.
2. Press  to access fields and make changes.
3. Press  to navigate to the field that you want to change. Press  to edit data.
4. Press  to select digits.
5. Press  to accept the new values or press  to cancel.
6. Press  to exit edit mode.

Setup Screen 1

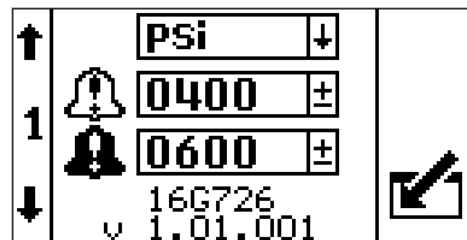
Setup screen 1 enables users to set units of measurement that will display on other screens, differential warning and differential alarm. Additionally, this screen displays the software number and version. Refer to the following table for more information.



Icon	Function
	<p>Warning Pressure</p> <p>Adjust the differential pressure deviation setpoint. The yellow light on the light tower will be flashing.</p> <p><i>Default: 400 psi</i></p> <p><i>Range: 0–2000 psi</i></p>
	<p>Alarm Pressure</p> <p>Adjust the differential pressure alarm setpoint. The red light on the light tower will be solid on.</p> <p>This is the main setting that determines how far apart your A and B pressures can be before shutting down the machine. If the machine shuts down too easily, increase this to a higher setpoint.</p> <p><i>Default: 600 psi</i></p> <p><i>Range: 0–2000 psi</i></p>

Setup Screen 2

Setup screen 2 enables users to set the high spray pressure alarm limit value, minimum spray pressure value and B pressure offset. Refer to the following table for more information.

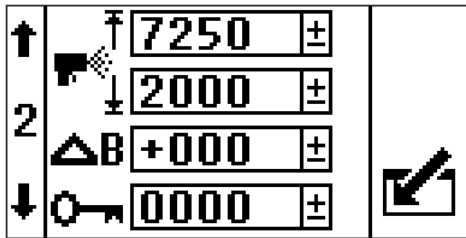

Icon	Function
	<p>High Pressure Limit</p> <p>Adjust the high pressure limit.</p> <p><i>Default:</i> 7250 psi (14 MPa, 138 bar)</p> <p><i>Range:</i> 0-7250 psi (50 MPA, 500 bar) maximum</p>
	<p>Minimum Spray Pressure Limit</p> <p>Adjust the lower spray pressure limit.</p> <p><i>Default:</i> 2000 psi (14 MPa, 138 bar)</p> <p><i>Range:</i> 0-7250 psi (50 MPA, 500 bar) maximum</p>
	<p>Password</p> <p>The setup screens can be protected by a password to restrict their accessibility. To set the password, see Set Password, page 24.</p> <p><i>Range:</i> 0-9999</p>

Icon	Function
	<p>B Side Pressure Offset</p> <p><i>Default:</i> 0 psi</p> <p><i>Range:</i> -999 to 999 psi</p> <p>Only used for remote mix manifold applications where there is a normal difference in pressure between A and B.</p> <p>Remote mix manifold applications should first be balanced with proper hose sizing and adjusting the mix manifold B restrictor. See manual 3A0590.</p> <p>Use if your differential alarm bar graph on the Spray screen is off to one side under normal spray conditions.</p> <p>See B Side Pressure Offset Example.</p>

B Side Pressure Offset Example

In normal spray conditions, the B pressure is 300 psi above the A pressure. The bar graph is offset to one side.

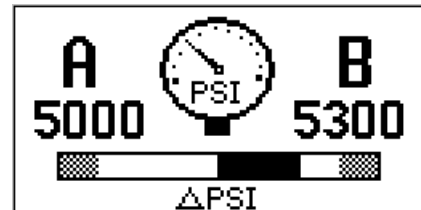

Enter a B offset pressure of +300 psi. Now the bar graph is centered.

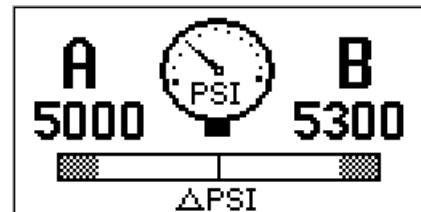

The differential pressure alarm now sees no differential when the B pressure is 300 psi higher than the A pressure. If the B pressure was normally 300 psi lower than the A pressure, you would enter -300 psi to balance the offset.

Setup Screen 3

Setup screen 3 enables users to scroll through all errors and clear the entire error log. The error log will display the most recent error on the top of the list . Refer to the following table for more information.

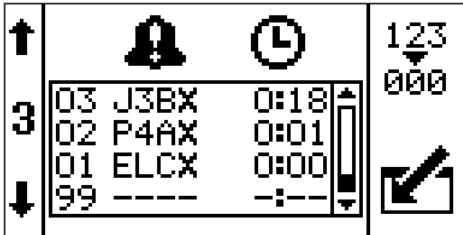

Icon	Function
	<p>Error Number</p> <p>The first column lists the error number. Once the system has more than the maximum errors allowed, then the oldest error will be over-written.</p> <p><i>Maximum: 99</i></p>
	<p>Error Code</p> <p>The second column lists the errors codes. See Error Codes, page 13.</p> <p><i>Maximum: 99</i></p>
	<p>Time</p> <p>The third column shows the time that the error occurred since the unit was last powered on. The time will always start at 0:00 when the system is powered up. This time will be logged as code ELCX.</p> <p><i>Format: Hours : Minutes</i></p> <p><i>Maximum: 999 : 59</i></p>
	<p>Reset</p> <p>Press the Reset icon to clear the entire error log.</p>

Set Password

Note

When the password is "0000," the setup screens can be accessed without entering a password.

1. Navigate to setup screen 2.

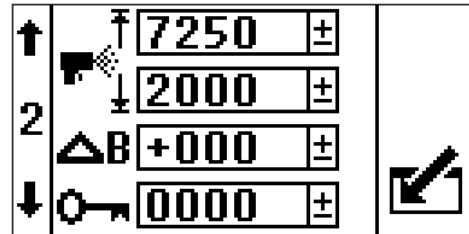

2. Press to access fields to make changes.
3. Press to navigate to the password field.
Press to edit data.
4. Press and to increment or decrement to the desired digits of the password.
5. Press to accept the password or press to cancel.
6. Press to exit edit mode.

Note

The password screen is shown when the setup screens are accessed and the password function has been enabled by changing the 0000 password.

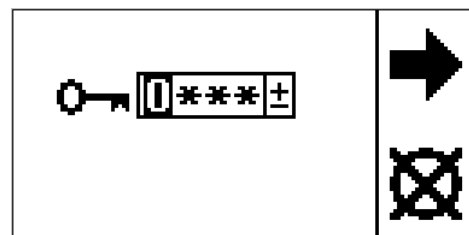

Figure 18

If you set and forget the password, please contact Graco Technical Assistance for a default password.

Run Mode Details

There are four Run Screens: Circulation Mode Active, Spray Mode Active, Alarm Active, and Deviation Active.

Circulation Mode Active

This is the run screen that appears after the power up screen. A and B pressure are shown. The bar across the bottom indicates the magnitude of the differential pressure with respect to the alarm setpoint. In Circulation Mode, all alarms are disabled except for the Air Solenoid Detection High Pressure A, and High Pressure B alarms

If the user needs to spray with one of the above errors active, set the Lower Spray Pressure Limit equal to the High Pressure Alarm Limit to enter Manual Bypass Mode. Only use Manual Bypass Mode for emergency operation. The control no longer monitors the pressures and will not shut off the sprayer.

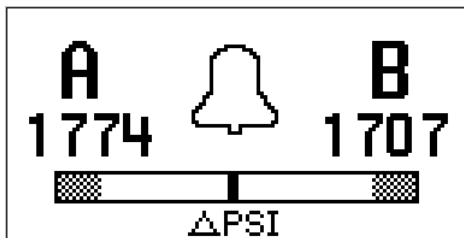



Icon	System Status
	<p>Indicates that you are in Circulation Mode and the fluid pressure is below the Lower Spray Pressure Limit.</p> <p>All alarms are disabled except for Air Solenoid Detection, High Pressure A, and High Pressure B alarms. The yellow light on the light tower will be solid on.</p> <p>This screen will also be used when in Manual Bypass Mode.</p> <p>Note</p> <p>All alarms and deviations are ignored in Bypass Mode. You will be allowed to spray bad material. The yellow light will be solid on.</p>

Spray Mode Active

This is the run screen that appears during spray mode. A and B pressure are shown. The bar across the bottom indicates the magnitude of the differential pressure with respect to the alarm setpoint.

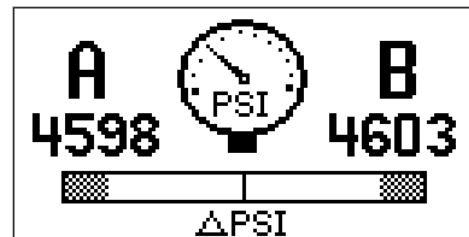
When the pressure first gets above the lower spray pressure limit, the user has 30 seconds to balance the system differential pressure so it is less than the differential pressure deviation and alarm limits. Then the system will automatically go into Spray mode and start monitoring all alarms and deviations.



Icon	System Status
	<p>Indicates that you are in spray mode, at least one of the pumps has pressure greater than the lower spray pressure limit, and the differential pressure is less than the differential pressure deviation setpoint.</p> <p>The green light on the light tower will be solid on.</p>

Alarm Active

This is the run screen that appears during an active alarm. A and B pressure are shown. The bar across the bottom indicates the magnitude of the differential pressure with respect to the alarm setpoint. Refer to the following table for more information.

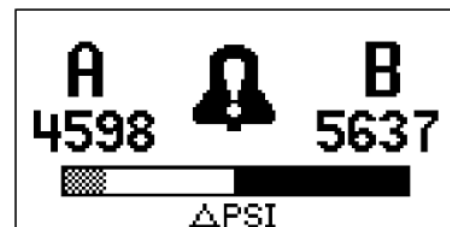

Icon	System Status
	<p>Indicates that there is an active alarm.</p> <p>The red light on the light tower will be solid on and the system is disabled.</p>

Deviation Active

This is the run screen that appears during an active deviation. A and B pressure are shown. The bar across the bottom indicates the magnitude of the differential pressure with respect to the alarm setpoint. Refer to the following table for more information.

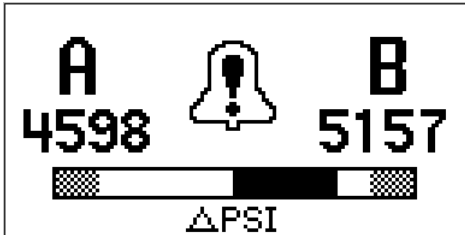

Icon	System Status
	<p>Indicates that there is an active deviation.</p> <p>The yellow light on the light tower will be flashing.</p> <p>The air to the motor is on. Once the deviation condition no longer exists it automatically generates the Spray Mode Active Run Screen</p>





Information Screen

The information screen is only available when an alarm, deviation, or advisory is active. It shows the active alarm code and the A and B pressure conditions at the time of the alarm, if applicable.

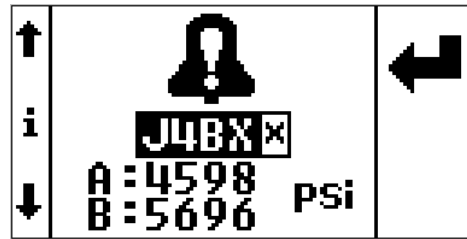
If the alarm condition occurs while on the run screen the information screen is automatically generated.

The red light on the light tower will be solid on. Refer to the following table for more information



Icon	System Status
	<p>Indicates that there is an active alarm.</p> <p>The red light on the light tower will be solid on and the system is disabled.</p>
	<p>Indicates that there is an active deviation.</p> <p>The yellow light on the light tower will be flashing.</p>
	<p>Indicates that there is an active advisory.</p> <p>The yellow light on the light tower will be solid on.</p>
	<p>Active Alarm Code</p> <p>See Error Codes, page 13.</p>

Appendix B - Breakout Module Connections

The following provides descriptions and pins of all connectors used on the breakout module. These can be used if the components are being wired directly to the breakout module.

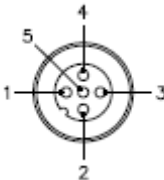
LCM Power Cable 1 — Blue	Pin Description	Pin Number
M12 Connector, 5 pin, Female, A code	Shield	1
Phoenix Contact Part Number 1694224	Power (12 V or 24 V)	2
	Ground	3
	CAN +	4
	CAN -	5

Solenoid Air Connector 3 — Red	Pin Description	Pin Number
M12 Connector, 5 pin, Female, A code	Solenoid Air Digital Output	4
Phoenix Contact Part Number 1542761	Not Used	2
	Not Used	1
	Digital Output Ground	3
	Not Used	5

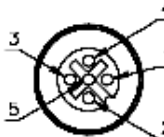
Light Tower Connector 4— Green	Pin Description	Pin Number
M12 Connector, 5 pin, Female, A code	Lamp 1 Green Digital Output	4
Phoenix Contact Part Number 1542761	Lamp 2 Yellow Digital Output	2
	Not Used	1
	Digital Output Ground	3
	Lamp 3 Red Digital Output	5

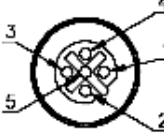
A Pressure Transducer 6— Blue	Pin Description	Pin Number
M12 Connector, 5 pin, Female, B code	Pressure Differential Analog Input +	4
Phoenix Contact Part Number 1543650	Pressure Differential Analog Input -	2
	Pressure Power (5 volt)	1
	Pressure Ground	3
	Shield Analog	5

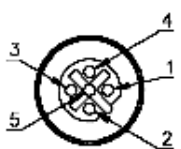
B Pressure Transducer 7—Red	Pin Description	Pin Number
M12 Connector, 5 pin, Female, B code	Pressure Differential Analog Input +	4
Phoenix Contact Part Number 1543650	Pressure Differential Analog Input -	2
	Pressure Power (5 volt)	1
	Pressure Ground	3
	Shield Analog	5

Accessories

16G410, Pressure Transducer Tee Adapter

For using the pressure transducers on systems other than a XP Sprayer.

303 stainless steel, 7250 psi (50 MPa, 500 bar), 1/4 npt(f) x 3/8 npt (f); 11/16-24 transducer mount on branch of tee.

16J717, Protective Bag

If the pressure monitor kit will be outside, use the protective bag for weather and over spray protection.

Technical Data

Pressure Transducers	
Fluid pressure range:	50-7250 psi (3-500 bar)
Power requirements for model 262940:	
Voltage:	90-260 VAC
Frequency:	50-60 Hz
Phase:	1
Amps:	1
Compressed air requirements for model 262942:	
Minimum air supply pressure	40 psi (2.75 bar)
Maximum air supply pressure	150 psi (10.3 bar)
Air Consumption	6 scfm
Turbine air pressure set point (pre-set inside box)	25 psi (1.72 bar)
Certification:	CE*

* When an Electrostatic Discharge (ESD) is applied to the display, the screen might clear. Turn the power supply off and on, or turn the turbine off and on.

Graco Standard Warranty

Graco warrants all equipment referenced in this document which is manufactured by Graco and bearing its name to be free from defects in material and workmanship on the date of sale to the original purchaser for use. With the exception of any special, extended, or limited warranty published by Graco, Graco will, for a period of twelve months from the date of sale, repair or replace any part of the equipment determined by Graco to be defective. This warranty applies only when the equipment is installed, operated and maintained in accordance with Graco's written recommendations.

This warranty does not cover, and Graco shall not be liable for general wear and tear, or any malfunction, damage or wear caused by faulty installation, misapplication, abrasion, corrosion, inadequate or improper maintenance, negligence, accident, tampering, or substitution of non-Graco component parts. Nor shall Graco be liable for malfunction, damage or wear caused by the incompatibility of Graco equipment with structures, accessories, equipment or materials not supplied by Graco, or the improper design, manufacture, installation, operation or maintenance of structures, accessories, equipment or materials not supplied by Graco.

This warranty is conditioned upon the prepaid return of the equipment claimed to be defective to an authorized Graco distributor for verification of the claimed defect. If the claimed defect is verified, Graco will repair or replace free of charge any defective parts. The equipment will be returned to the original purchaser transportation prepaid. If inspection of the equipment does not disclose any defect in material or workmanship, repairs will be made at a reasonable charge, which charges may include the costs of parts, labor, and transportation.

THIS WARRANTY IS EXCLUSIVE, AND IS IN LIEU OF ANY OTHER WARRANTIES, EXPRESS OR IMPLIED, INCLUDING BUT NOT LIMITED TO WARRANTY OF MERCHANTABILITY OR WARRANTY OF FITNESS FOR A PARTICULAR PURPOSE.

Graco's sole obligation and buyer's sole remedy for any breach of warranty shall be as set forth above. The buyer agrees that no other remedy (including, but not limited to, incidental or consequential damages for lost profits, lost sales, injury to person or property, or any other incidental or consequential loss) shall be available. Any action for breach of warranty must be brought within two (2) years of the date of sale.

GRACO MAKES NO WARRANTY, AND DISCLAIMS ALL IMPLIED WARRANTIES OF MERCHANTABILITY AND FITNESS FOR A PARTICULAR PURPOSE, IN CONNECTION WITH ACCESSORIES, EQUIPMENT, MATERIALS OR COMPONENTS SOLD BUT NOT MANUFACTURED BY GRACO. These items sold, but not manufactured by Graco (such as electric motors, switches, hose, etc.), are subject to the warranty, if any, of their manufacturer. Graco will provide purchaser with reasonable assistance in making any claim for breach of these warranties.

In no event will Graco be liable for indirect, incidental, special or consequential damages resulting from Graco supplying equipment hereunder, or the furnishing, performance, or use of any products or other goods sold hereto, whether due to a breach of contract, breach of warranty, the negligence of Graco, or otherwise.

FOR GRACO CANADA CUSTOMERS

The Parties acknowledge that they have required that the present document, as well as all documents, notices and legal proceedings entered into, given or instituted pursuant hereto or relating directly or indirectly hereto, be drawn up in English. Les parties reconnaissent avoir convenu que la rédaction du présente document sera en Anglais, ainsi que tous documents, avis et procédures judiciaires exécutés, donnés ou intentés, à la suite de ou en rapport, directement ou indirectement, avec les procédures concernées.

Graco Information

For the latest information about Graco products, visit www.graco.com.

To place an order, contact your Graco Distributor or call to identify the nearest distributor.

Phone: 612-623-6921 or **Toll Free:** 1-800-328-0211 **Fax:** 612-378-3505

All written and visual data contained in this document reflects the latest product information available at the time of publication.

Graco reserves the right to make changes at any time without notice.

Original instructions. This manual contains English, MM 3A1331

Graco Headquarters: Minneapolis

International Offices: Belgium, China, Japan, Korea

GRACO INC. P.O. BOX 1441 MINNEAPOLIS, MN 55440-1441

Copyright 2011, Graco Inc. is registered to ISO 9001

Revised 04/2011

Free Manuals Download Website

<http://myh66.com>

<http://usermanuals.us>

<http://www.somanuals.com>

<http://www.4manuals.cc>

<http://www.manual-lib.com>

<http://www.404manual.com>

<http://www.luxmanual.com>

<http://aubethermostatmanual.com>

Golf course search by state

<http://golfingnear.com>

Email search by domain

<http://emailbydomain.com>

Auto manuals search

<http://auto.somanuals.com>

TV manuals search

<http://tv.somanuals.com>