

**PRO PLUS<sup>™</sup> PORTABLE WHEELCHAIR SCALE  
MODEL 2450KL**

**BALANCE PORTATIVE PRO PLUS<sup>™</sup>  
POUR FAUTEUIL ROULANT  
MODELE 2450KL**

**BALANZA PORTABLE PRO PLUS<sup>™</sup> PARA  
SILLA DE RUEDAS  
MODELO 2450KL**



**OPERATION MANUAL**

**MODE D'EMPLOI**

**MANUAL DE OPERACIÓN**

# PRO PLUS™ PORTABLE WHEELCHAIR SCALE MODEL 2450KL

**Thank you** for your purchase of this product.

Please read this manual carefully and keep it handy for ready reference.

**Merci** d'avoir acheté ce produit.

Veuillez lire attentivement ce manuel et le garder à portée de main pour pouvoir le consulter à tout moment

**Gracias** por la adquisición de este producto.

Lea por favor este manual cuidadosamente y manténgalo a su alcance para una pronta referencia.

<b>ENGLISH</b> .....	<b>1</b>
<b>FRANÇAIS</b> .....	<b>23</b>
<b>ESPAÑOL</b> .....	<b>45</b>

## TABLE OF CONTENTS

CAUTION AND WARNING.....	2
SPECIFICATIONS.....	2
SET UP.....	3
OPERATION INSTRUCTIONS.....	6
MAINTENANCE.....	17
TROUBLESHOOTING.....	18
CALIBRATION PATH.....	19
EXPLODED VIEW OF SCALE.....	19
PARTS LIST.....	21
WARRANTY.....	22

## CAUTION AND WARNING

To prevent injury and damage to your scale, please follow these instructions very carefully.

- For accurate weighing the scale must be placed on a flat and a stable surface, locking screw is locked properly and the scale bottom is not touching the floor.
- For accurate weighing, verify proper operation according to the procedure described in this manual before each use.
- Do not use in the presence of flammable materials.
- Operating at other voltages and frequencies than specified could damage the equipment.
- If the “LOW BAT” indicator activates, for accurate weighing, replace the batteries or connect the scale to an AC power source as soon as possible.

## SPECIFICATIONS

### GENERAL

Health o meter's Pro Plus™ Portable Wheelchair Scale Model 2450KL uses highly sophisticated microprocessor technology. Each precision instrument is designed to provide accurate, reliable and repeatable weight measurements and features that make the weighing process simple, fast and convenient.

The scale is set up to use motion-sensing weighing technology, to determine the actual weight of a moving patient. The scale may be changed to measure live weight; see page 13 for instructions on changing the scale setting.

The weight can be display in pounds (decimals, fractions of a lb or lb/oz) or in kilograms. The scale features low self-weight, width-adjustment mechanism to fit wheelchair various dimensions and a display assembly stand.

The unit can be operated using its AC adapter or by 6-D cell batteries (not included).

### SCALE SPECIFICATIONS

<b>Capacity and Resolution</b>	600 Lb x 0.2 Lb / ¼ lb / 4 oz (270 Kg x 0.1 Kg)
<b>Power Requirements</b>	Adapter 120VAC - 6VDC - 60Hz or 6 x D size batteries
<b>Environmental</b>	Operating temperatures: 50°F to 95°F (10°C to 35°C) Storage temperatures: 30°F to 125°F (0°C to 50°C) Humidity: 85%
<b>Physical Dimensions</b>	<b>Adjustable Platform</b> Length: 31¾" (80 cm) Width: 23½" to 31¾" (60 cm to 80 cm) Weight: 23.6 Lb (10.7 Kg)

# SET UP

## Parts List:

- |                             |                     |
|-----------------------------|---------------------|
| (1) Scale Assembly          | (1) AC Adapter      |
| (1) Display Assembly        | (1) Load Cell Cable |
| (4) Plastic Feet Assemblies |                     |

Tools required: Phillips head screwdriver.

Remove each assembly from the carton and unwrap packing material carefully to prevent scratching the unit's parts.

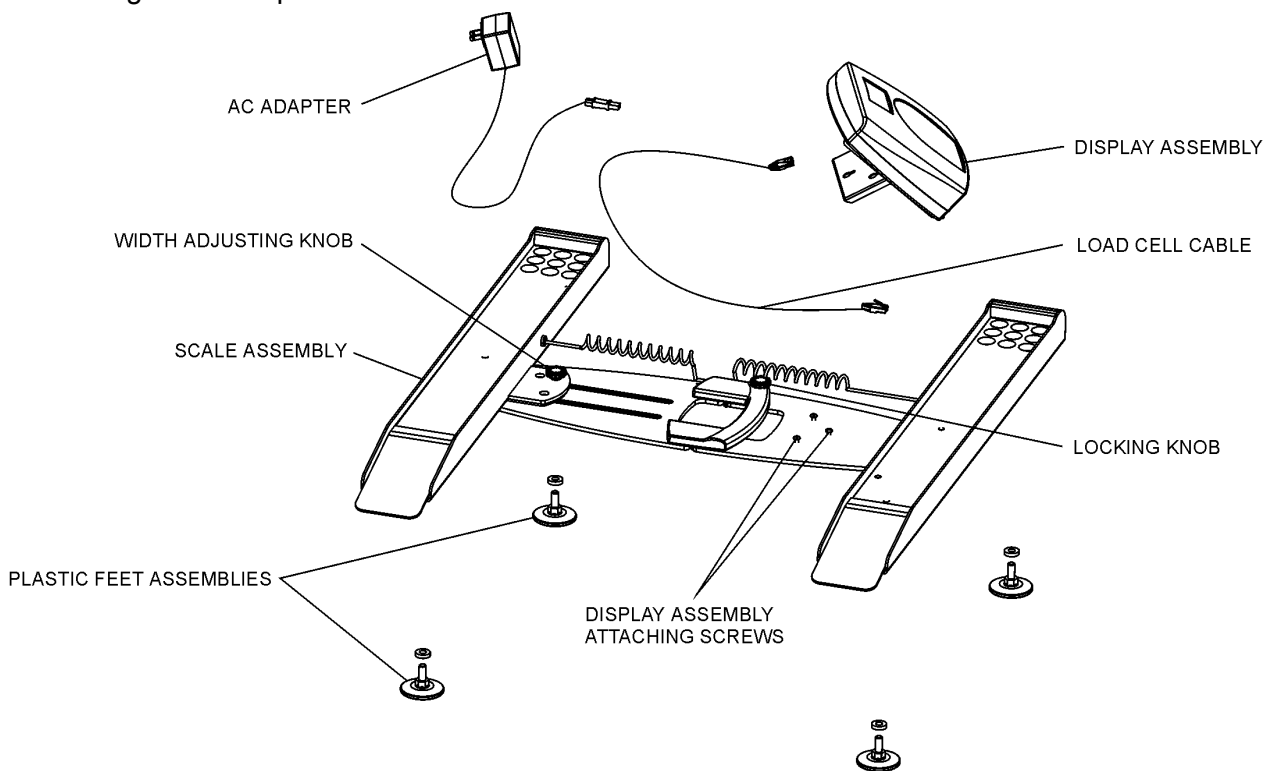

Figure 1. Assembly After Shipment

## **Scale - Opening and Assembly Instructions**

1. Begin with the scale in the folded upright position resting on its ramps, as in Figure 2a.
2. Lightly slide up the display assembly in the direction of the handle and remove it from the scale.
3. Open the stand at the back of the display assembly and place the display assembly on a flat, stable table or on the floor.
4. Open the scale and place it upside down on a level floor.
5. Screw in the four plastic feet assemblies; do not tighten. Turn the scale assembly right side up on its feet.
6. Tighten the locking knob located on the carrying handle

**NOTE:** For accurate weighing, the locking knob must be completely tightened.

7. Make sure that all scale parts are leveled at least  $\frac{1}{2}$ " from the floor (pay special attention to the two folding hinges in the center). If necessary, raise the scale by opening all four plastic feet.
8. Bring the wheelchair close to the scale ramps. Unscrew the width adjusting knob and adjust the scale width by moving the left ramp.

**NOTE:** Often front and rear wheels on wheelchairs are not perfectly aligned. Make sure that both front and rear wheels mount the ramps.

# SET UP

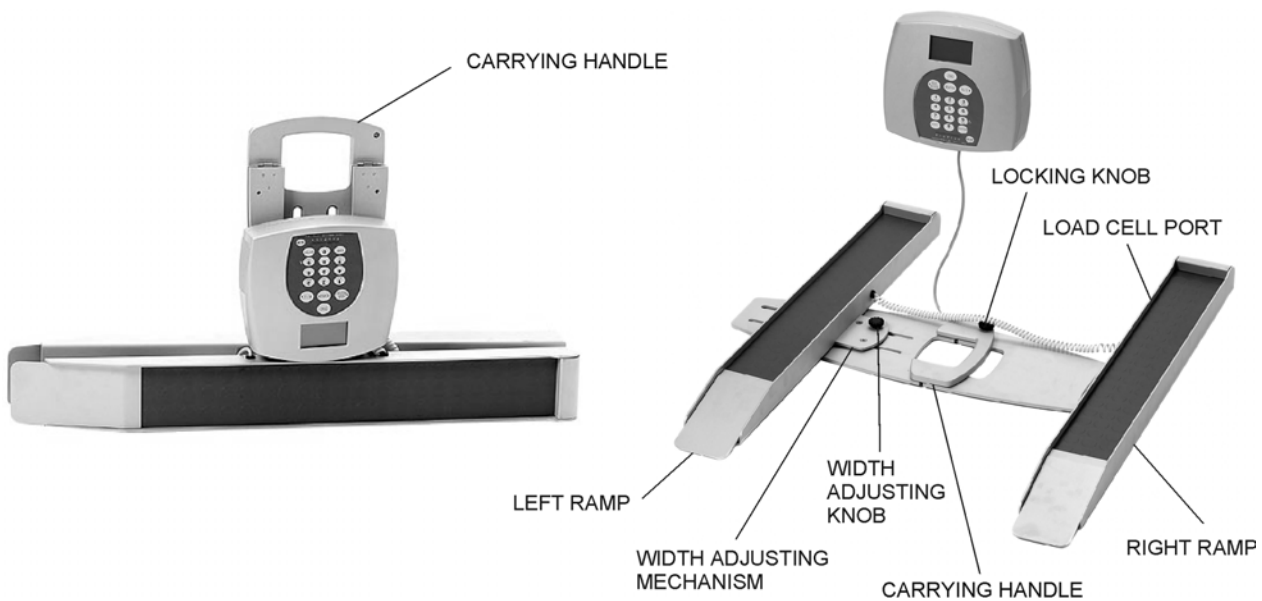

Figure 2a

Figure 2b

9. Tighten the width adjusting knob in order to lock the width adjusting mechanism.
10. Remove the stand at the rear of the display assembly by unscrewing 4 screws, in order to connect load cell cable and power cord to the display assembly (see Figure 3).
11. Connect the load cell cable connector to the load cell port on the rear of the display assembly and insert and secure the cable into the center channel in the display.
12. Connect power cord to the power port in the display assembly and insert and secure the cable into the 2nd channel from the left in the display.
13. Install the stand on the rear of the display assembly and secure with four screws.
14. Connect the load cell cable connector to the load cell port on the inner side of the right ramp.
15. Screw/unscrew the plastic feet to level the scale.
16. After the first assembly, for scale folding and moving purposes, leave the four plastic feet, power cord and load cell cable connected to the display assembly for the next use.

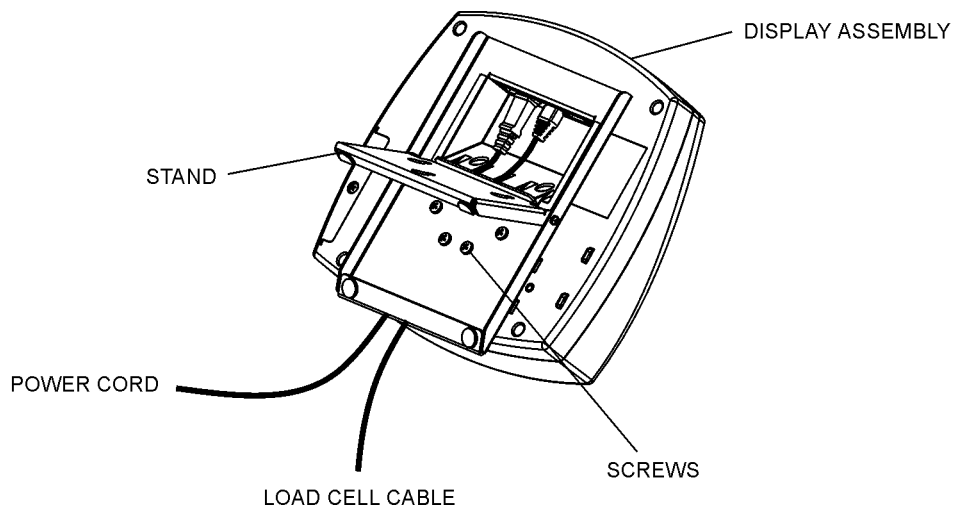

Figure 3.

# SET UP

## Preparing the Scale for Use

1. Remove protective plastic film from keypad and display.
2. Place batteries in the battery holder (see “Replacing Batteries”).
3. Plug the scale’s AC adapter into the power source.
4. Press the ON/OFF button to turn the scale on. The display will show “Health o Meter Pro-Plus” and then “000Lb00oz”.<sup>(a)</sup>
5. Place a weight [not to exceed 600 Lb (270 Kg)] on the scale. The display should read “WEIGHING” until the weight calculation is complete and the weight is displayed.
6. Press the KG/LB button to select the weight mode (Lb/Kg).<sup>(b) \*</sup>
7. Press the REWEIGH button; the scale should perform the weighting process again.
8. Remove the weight from the scale, the scale will return to zero and the display will read “ZERO” on the left upper side of the screen along with “000Lb00oz”.
9. Disconnect the scale’s AC adapter from the power source. The scale will shut off. Press On/Off and the scale will switch to battery power.

**NOTE:** If the set up procedure failed, refer to the troubleshooting instructions. If the problem is not corrected, refer to qualified service personnel.

<sup>(a)</sup> To adjust the display backlight and/or contrast, please refer to page 13.

<sup>(b)</sup> To change the display mode in pounds to fractions or decimals, please refer to page 8.

## Replacing Batteries

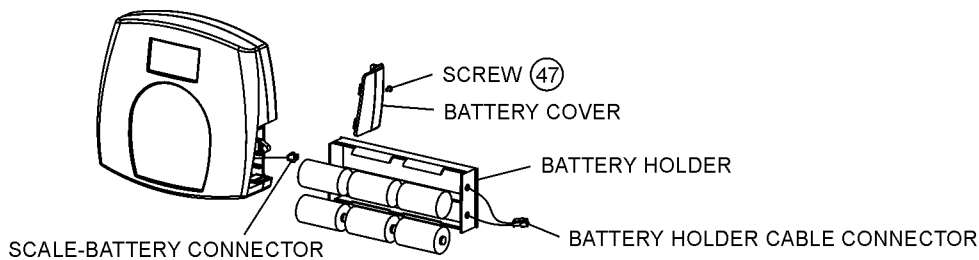

Figure 4. Replacing Batteries

(refer to the Parts List on page 21 for details on parts followed by (#))

1. Unplug the scale.
2. Remove the battery cover from the display assembly.
3. Disconnect battery holder cable connector from the scale-battery connector.
4. Carefully remove the battery holder by sliding it out the display assembly.
5. Replace the batteries with new ones.\*\*
6. Carefully position the battery holder into the display assembly.
7. Plug the battery holder cable connector to the scale-battery connector.
8. Attach the battery cover to the display assembly and install the screw.

\* To change the scale default units to kilograms, or to deactivate the LB/KG button, please contact Technical Support at 1 800 638-3722 or +1 708 598-9100.

\*\* We recommend the use of EVEREADY Energizer® e2™ batteries.

## OPERATION INSTRUCTIONS

1. Press the ON/OFF button to turn the scale on.
2. Wait until "000Lb00oz" and "ZERO" on the left side of the display will appear.
3. Bring the wheelchair close to the scale ramps. Unscrew the width adjusting knob and adjust the scale width by moving the left ramp.

**NOTE:** Often front and rear wheels on wheelchairs are not perfectly aligned. Make sure that both front and rear wheels mount the ramps.

4. Tighten the width adjusting knob in order to lock the width adjusting mechanism.
5. Make sure that all scale parts are leveled at least  $\frac{1}{2}$ " from the floor (pay special attention for two folding hinges in the center). If necessary, raise the scale by opening all four plastic feet.
6. If the wheelchair weight is known, enter the TARE value according to instructions in the "Menu", para 02. If the wheelchair weight is unknown, place the wheelchair only on the platform; press REWEIGH. Enter the Automatic TARE by pressing the TARE button. Display will read "000Lb00oz".
7. Move the wheelchair and patient over the ramps until the front wheelchair wheels are stopped by the ramp guardrails. The display should read "WEIGHING" until the weight of the patient is displayed.
8. We recommend reweighing after the patient is sitting still on the wheelchair on the platform by pressing the REWEIGH button.
9. Remove the wheelchair and patient from the scale by moving straight back off the ramp.

**NOTE:** The scale will always default to the settings and units last used.

# OPERATION INSTRUCTIONS



Figure 5. Keypad

ITEM	DESCRIPTION	FUNCTION
	POWER	Turns scale ON and OFF.
	ZERO	Zeros the scale prior to weighing.
	HOLD/RELEASE	Holds the value of the weighed object on the display until the button is pressed again to clear the value. Also used to scroll down in the menu.
	REWEIGH	Allows repeated weighing of the patient without stepping off the scale.
	KG/LB button	Toggles between kilograms or pounds. Also used to scroll up in the menu.
	MENU	Enters the menu of the scale.
	BMI	Prompts entry of data to calculate the patient's Body Mass Index (BMI).
	PRINT	Prints patient's data (if printer is connected to the scale).
	ID	Prompts entry of patient's identification number (ID). This ID will be stored with all the weighing made until is cleared or a different ID is stored.
	TARE	Prompts entry of TARE value that will be deducted from the weight on the platform. Also releases tare weight (returns display to zero).
	EXIT	Reverts back one step when in the menu and data entry modes.
	ENTER	Used to enter commands and values into the scale.



# OPERATION INSTRUCTIONS

## MENU

In the menu screen the user can set preferences and/or instruct the scale how to handle stored data. The menu can be navigated using the up and down keys (▲▼) or by entering the associated menu position number with the keypad. The menu has a “roll-over” way of working: when the user scrolls to the bottom of the menu and presses the down button, it will return to the top of the menu.

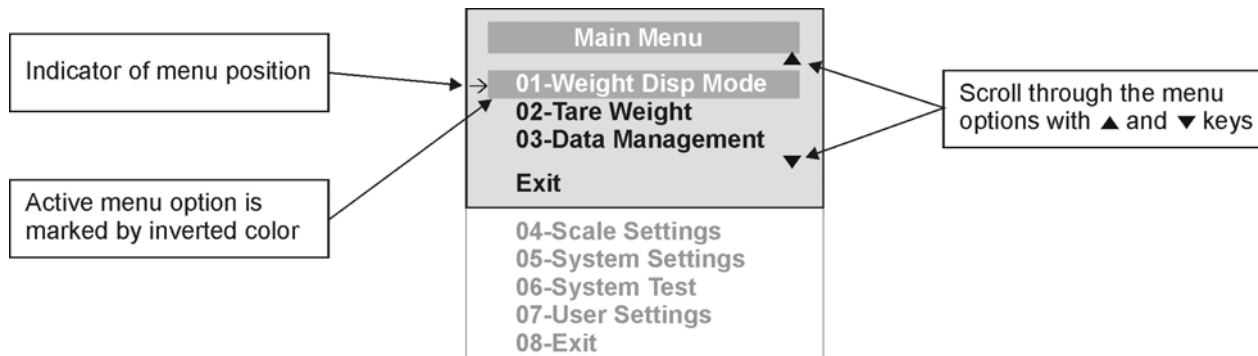

Figure 6. Main Menu

### 01 WEIGHT DISPLAY MODE

(only applies to pound values, NOT the metric values)

The user can set the screen display value in either fraction of pound ( $\frac{1}{4}$ ,  $\frac{1}{2}$  or  $\frac{3}{4}$  lb), in pounds and ounces (resolution of 4 ounces) or in decimals (resolution of 0.2 lb). When kg is selected as the units of use, these settings have no effect. The mode that is selected is used through all the screens.

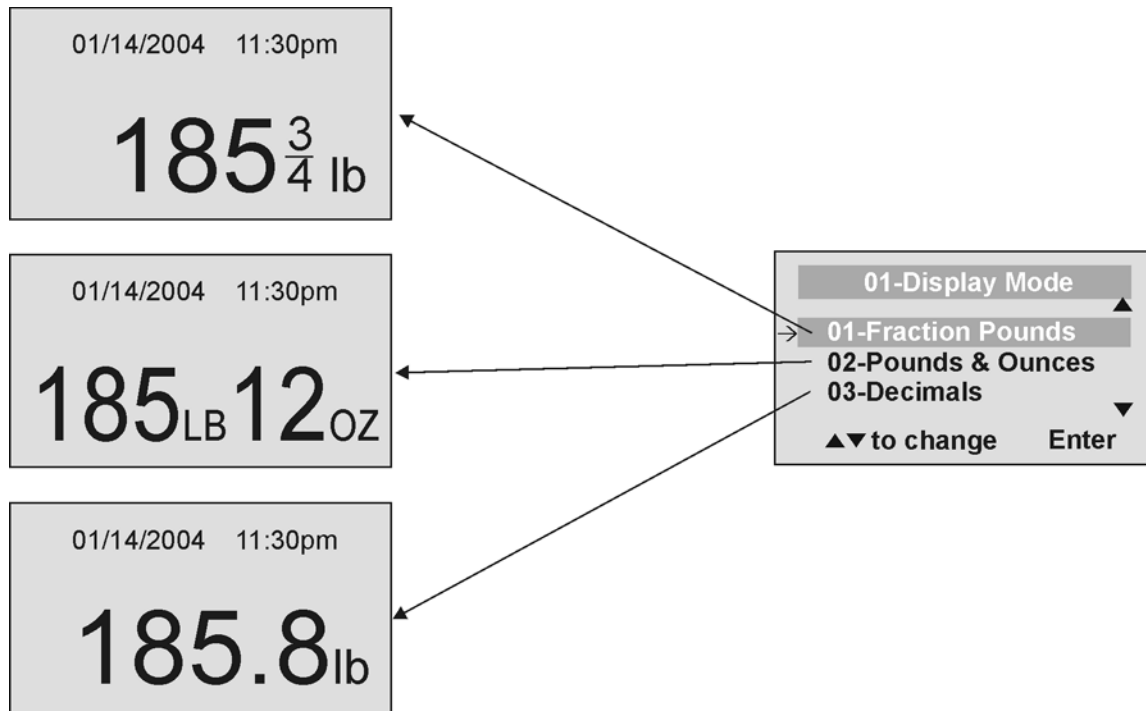

Figure 7. Weight Display Mode

# OPERATION INSTRUCTIONS

## 02 TARE WEIGHT

**NOTE:** Due to the scale's sensitivity, we recommend using the REWEIGH function prior to setting the TARE weight, in order to eliminate any operator interference with the item to be tared out.

There are two ways to manually enter a tare weight (such as the weight of a wheelchair, shoes, etc): press MENU (1) and select option 02-Tare Weight or press TARE (9). If there is no weight on the scale platform (value displayed is zero and there is no tare) and the user presses the TARE button (9), the Tare Weight window appears and prompts the user to enter the TARE value and to press ENTER. NOTE: The tare weight must be entered using the following increments: 4oz, 0.2lb, 1/4lb. The value entered will display in minus (-). After the TARE has been entered, the scale goes back to normal operation. This TARE value is stored in memory until changed or cleared.

**Important:** The TARE weight cannot exceed 125 lb.

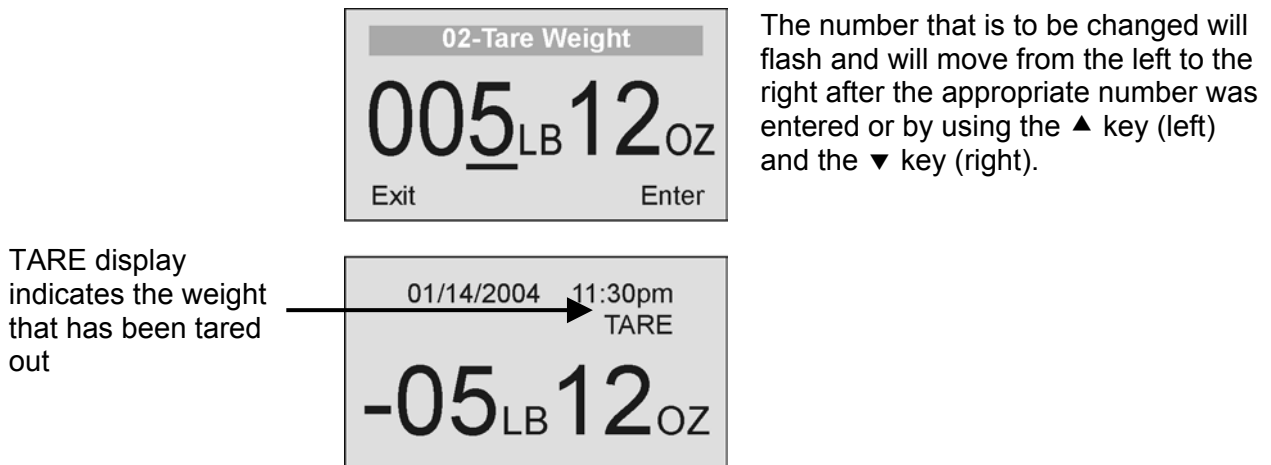

Figure 8. Tare Weight

### Automatic Tare

The user can set a tare weight by pressing the TARE button (9) while there is a weight on the scale platform. The display will come to zero and TARE will be displayed to indicate there is a tare value in the memory (as displayed in Figure 8 above).

### Removing the Tare

Additional pressing of the TARE button will delete the tare value from memory, TARE will disappear from the display and the scale will resume normal operation.

## 03 DATA MANAGEMENT

The scale manages patient data including patient ID, weight, height, tare and BMI. The value is stored in memory or transferred to PC. This function is performed by opening a new data file.

OPENING A NEW DATA FILE:

1. Press the ID button (7).
2. Using the keypad, type in the identification number.
3. Press ENTER.

This scale will also calculate Body Mass Index (BMI).

CALCULATING BMI:

1. Place the patient on the scale platform.
2. Press the BMI button (2).

# OPERATION INSTRUCTIONS

3. The scale will prompt you to enter the patient's height. Use the keypad to enter the height in 1/4" (1=1/4, 2=1/2, 3=3/4) or 1 cm increments (use inches for weight in lb, cm for kg). Press ENTER.
4. Display will read the patient's BMI.

The scale offers you two options to manage your information: to transfer/download the values or to store them. The first option automatically downloads (transfers) the value to your PC. The second option stores the value in memory. The maximum capacity of the scale is 270 files of different data.

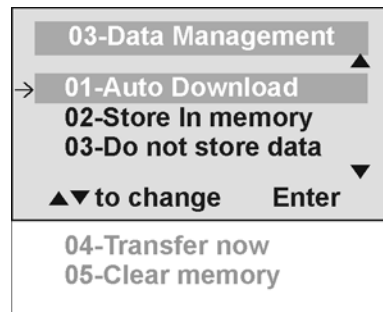

## 01 Auto Download

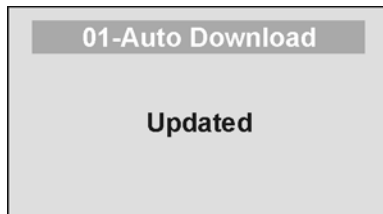

Automatic Download is the default option and will transfer the value to the PC as soon as the patient steps off the scale or when the user presses the HOLD/RELEASE button if it was kept in "HOLD". If no PC is connected, the value is not transferred and not stored and will be lost after the load is removed from the scale.

## 02 Store in memory

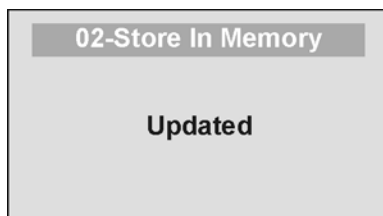

The value is stored in memory for later download to PC. If the memory is close to full the user will be warned and given the option to transfer all values to the PC or to clear the memory of all values.

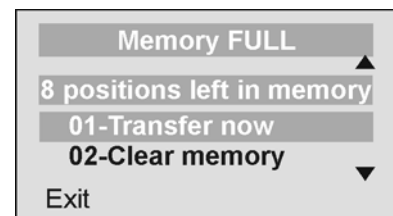

## 03 Do not store data

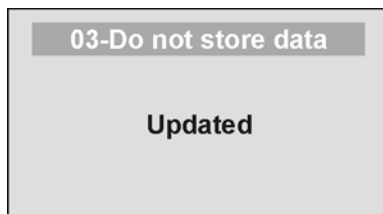

All the data will be cleared.

# OPERATION INSTRUCTIONS

## 04 Transfer now

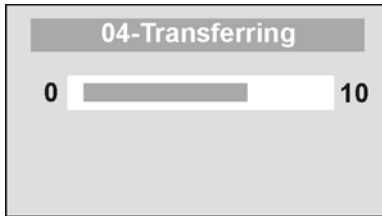

All the values stored in memory are transferred to the PC and the scale memory is cleared of all values. If the transfer was unsuccessful, the values are kept in memory until successfully transferred or cleared.

## 05 Clear memory

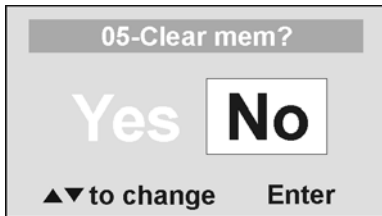

All the values stored in memory will be cleared.

## 04 SCALE SETTINGS

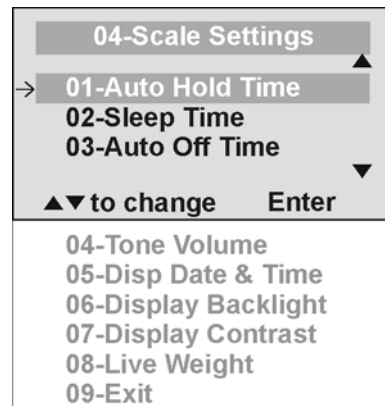

## 01 Auto Hold Time

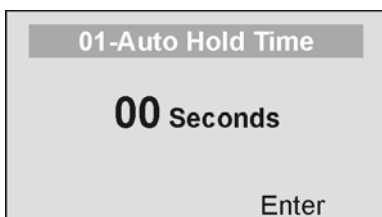

The user can determine how long to display the weight reading once it is determined, regardless of whether the patient remains on the platform. The scale defaults to no Auto Hold Time. The maximum setting is 20 seconds Hold Time.

## 02 Sleep Time

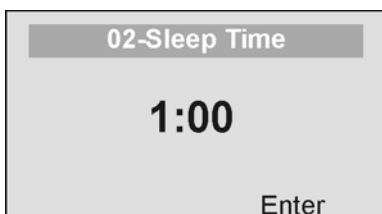

The user can set the time elapsed before the scale goes into the sleep mode. The default is 1 minute. When the scale goes into sleep mode, STANDBY is displayed on the screen.

# OPERATION INSTRUCTIONS

## 03 Auto Off Time

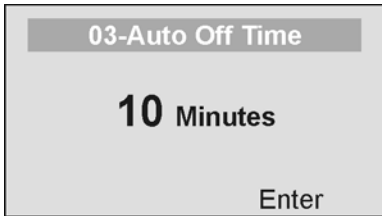

The user can determine how long the scale will operate before turning off automatically due to inactivity. Default time is 10 minutes. If the value is set to zero, the auto off function is disabled.

## 04 Tone Volume

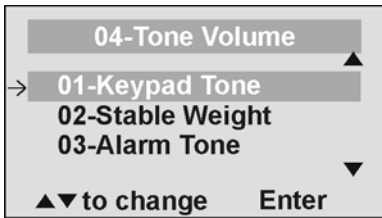

There is an option to adjust the beeping tone of the scale. This tone should sound when the scale has determined the weight on the platform, when a key is pressed, after the scale is turned on, at the end of self-test, or in the case of fault or warning.

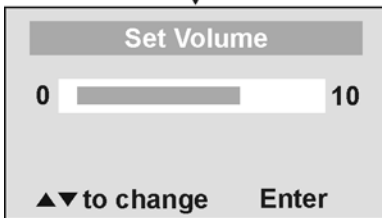

Use the ▲ and ▼ keys on the keypad to adjust the volume. Whenever the user presses the key to change a volume, a beep will sound to indicate the set volume level.

## 05 Display Date and Time

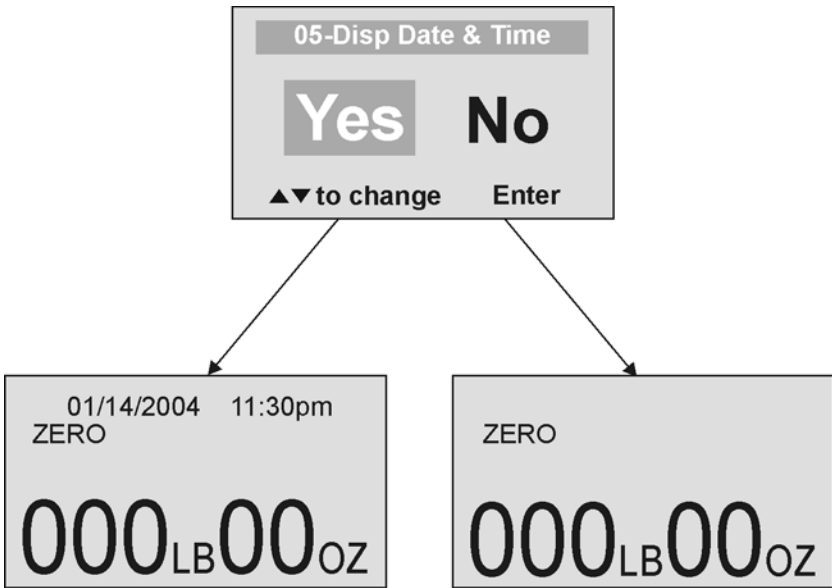

This option will turn on or turn off the date and time display.

# OPERATION INSTRUCTIONS

## 06 Display Backlight

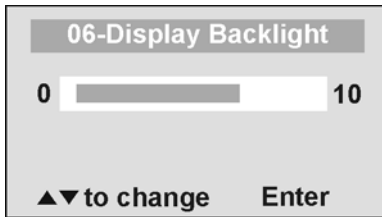

The user can set the brightness of the backlight.

## 07 Display Contrast

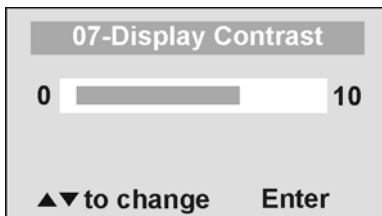

The user can set the brightness of the LCD.

## 08 Live Weight

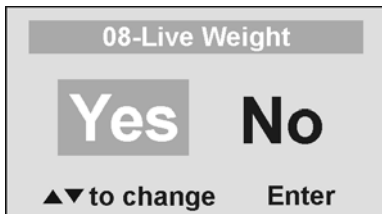

By selecting “Yes” the user can set the Live Weight mode to deactivate the motion-sensing mode. In the Live Weight mode the weight displayed will fluctuate with the patient’s movement; the scale will not lock on quickly to the weight as is the case in the motion-sensing mode.

Press the REWEIGH button to operate the motion-sensing mode and to determine the correct weight on the screen. To revert back to motion-sensing mode, change the Live Weight setting to “No”.

## 05 SYSTEM SETTINGS

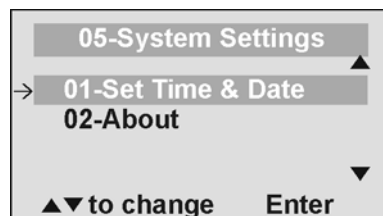

## 01 Set Time & Date

The user can set the time and date using the keypad.

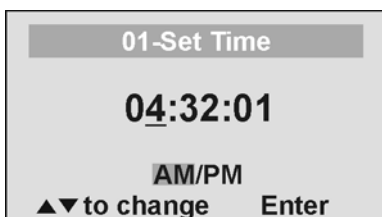

To set the time move between hours, minutes and seconds using the up and down keys ▲▼ and enter the values on the keypad. To jump to the AM/PM line press the ENTER button once.

# OPERATION INSTRUCTIONS



Set the date using the up and down keys ▲▼ and enter the values on the keypad.

## 02 About

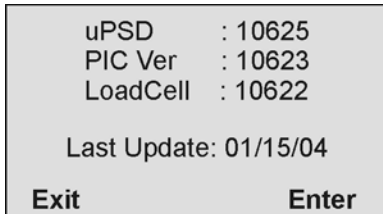

This screen displays the software version of the scale.

## 06 SYSTEM TEST

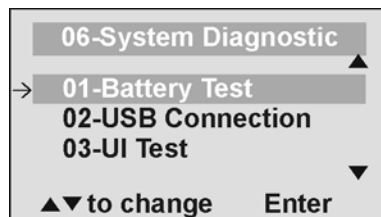

### 01 Battery Test

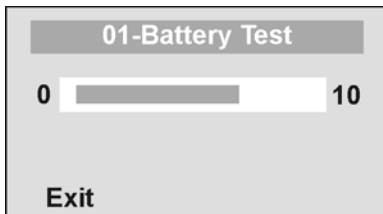

The scale will display the estimated amount of battery life remaining until the batteries will have to be replaced.

**NOTE:** In order to complete the battery test, the scale must be powered by batteries only. Unplug the scale from AC power source prior to battery test.

### 02 USB Connection



The scale will test the connection to the PC and will display a message "Connection is OK" or "NO Connection". If "NO Connection" is displayed, check your USB connections on the scale and on your PC and retest the connection. Refer to qualified service personnel if problem persists.

# OPERATION INSTRUCTIONS

## 03 UI Test

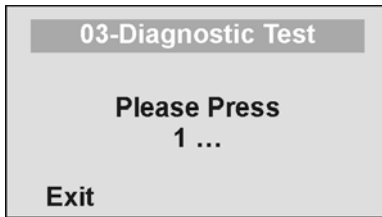

The scale has a diagnostic routine where it tests the User Interface (UI) hardware functionality (LCD, keypad). In order to do this the user has to press all the keys according to the messages displayed on the screen.

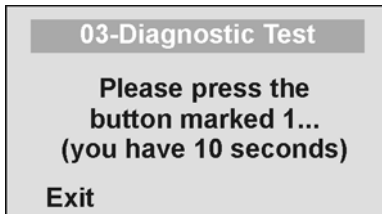

If the requested command was not received or wrong button was pressed, the following message will be displayed.

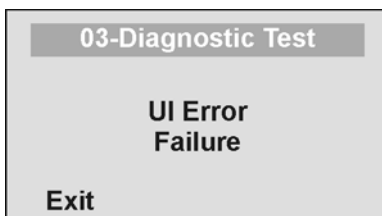

If after 10 seconds the requested command was not received, the following message will be displayed. If "UI Error Failure" is displayed, refer to qualified service personnel.

## 07 USER SETTINGS

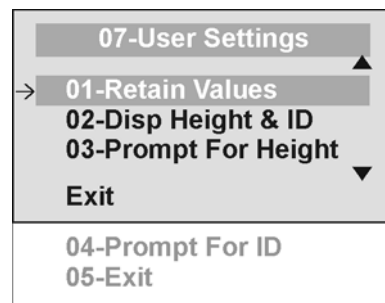

### 01 Retain Entered Values

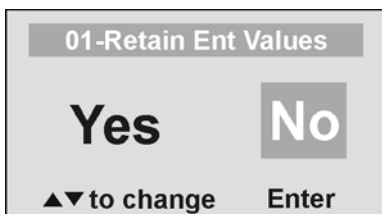

This option allows the user to use the same values for ID, height and TARE between weighing. If this option is disabled, the user has to re-enter these values for each reading. If the values are not entered, only the weight is stored.

NOTE: These values cannot be retained by ID number.



# OPERATION INSTRUCTIONS

## 02 Disp Height & ID

02-Disp Height & ID

**Yes** **No**

▲▼ to change Enter

When the user selects to display the height and ID of the user, it will be displayed at the bottom of the screen. We recommend the use of this function to ensure that the patient's correct ID and height have been entered.

01/14/2004 11:30pm  
ZERO

**5<sup>3</sup>/<sub>4</sub> lb**

Height: 6ft00 0/0in  
ID: 981723737123

01/14/2004 11:30pm  
ZERO

**5<sup>3</sup>/<sub>4</sub> lb**

## 03 Prompt For Height

03-Prompt For Height

**Yes** **No**

▲▼ to change Enter

When this option is activated, the user will be asked to enter the patient's height after every weighing.

01/14/2004 11:30pm

**153<sup>3</sup>/<sub>4</sub> lb**

Please enter Height:  
0ft00 0/0in

▲▼ to change Enter

## 04 Prompt For ID

04-Prompt For ID

**Yes** **No**

▲▼ to change Enter

When this option is activated, the user will be asked to enter the patient's ID number after every weighing.

01/14/2004 11:30pm

**153<sup>3</sup>/<sub>4</sub> lb**

Please enter ID:  
2345872336

▲▼ to change Enter

# MAINTENANCE

## **GENERAL**

This section provides instructions for maintenance, cleaning, troubleshooting and operator replaceable parts for the Pro Plus™ Portable Wheelchair Scale Model 2450KL. Maintenance operations other than those described in this section should be performed by qualified service personnel.

## **MAINTENANCE**

Before first use and after periods of non-use, check the scale for proper operation and function. If the scale does not operate correctly, refer to qualified service personnel.

1. Check overall appearance of the total scale for any obvious damage, wear and tear.
2. Inspect AC adapter for cord cracking or fraying or for broken or bent prongs.

## **CLEANING**

Proper care and cleaning is essential to ensure a long life of accurate and effective operation.

### **Disconnect the scale from the AC power source.**

1. Clean all external surfaces with a clean damp cloth or tissue. Mild soap and water solution may be used. Dry with a clean soft cloth.
2. Do not immerse the scale into cleaning or other liquid solution.
3. Do not use Isopropyl Alcohol or other solutions to clean the display surface.

# TROUBLESHOOTING

Refer to the following instructions to check and correct any failure before contacting service personnel.

<b>SYMPTOM</b>	<b>POSSIBLE CAUSE</b>	<b>CORRECTIVE ACTION</b>
Scale does not turn on	<ol style="list-style-type: none"> <li>1. Dead Battery</li> <li>2. Faulty electrical outlet</li> <li>3. Bad power supply</li> </ol>	<ol style="list-style-type: none"> <li>1. Replace batteries</li> <li>2. Use a different outlet</li> <li>3. Replace adapter</li> </ol>
Questionable weight or the scale does not zero	<ol style="list-style-type: none"> <li>1. External object interfering with the scale</li> <li>2. The display did not show "0.0" before weighing</li> <li>3. Scale is not placed on a level floor</li> <li>4. Scale is out of calibration</li> <li>5. Improper Tare</li> </ol>	<ol style="list-style-type: none"> <li>1. Remove interfering object from the scale</li> <li>2. Ask the patient to get off the scale, zero the scale and begin weighing process again</li> <li>3. Place the scale on a level floor and begin weighing process again</li> <li>4. Check weight with known weight value</li> <li>5. Place the item to be tared on the scale ramps. Press REWEIGH. Once the weight of the item is displayed, press TARE. Place the patient and the tared item back on the scale. Press REWEIGH again.</li> </ol>
Weighing is performed but the display shows "weigh" and "reweigh" every few seconds; the weighing process takes too long and no weight is displayed.	The patient is not sitting still	Ask the patient to be still or you can change to live weight setting
The display shows "Overload" message	The load on the scale exceeds the capacity (600 Lbs)	Remove the excess weight and use the scale according to its limits
The display shows "LOW BAT" message	The batteries are empty	Replace batteries according to instructions
The display shows "Load Cell Error" message	There is a problem with one or more load cells or the load cell cable is disconnected.	Check load cell cable connection at the display and platform assembly ports. If the problem is not corrected, refer to qualified service personnel to replace the defective load cell

# CALIBRATION PATH

The calibration is performed in Kg or Lb, according to the units of measure used upon entering into the calibration path.

Operator Action	Display
1. Press ON/OFF button and immediately press and hold HOLD/RELEASE button for 3-4 seconds	Calibration Process
2. Press ENTER	Enter load weight 600.0
3. Using ▲▼ keys and/or the keypad, set the calibration load to at least 200 lbs (for best results and greater accuracy, use a 600 lb weight). Press ENTER	Zero calibration Please clear the scale
4. Please clear the scale platform and press ENTER	Zero calibration Please wait
5. Please wait without touching or shaking the scale until the zero calibration process is finished	Weight calibration Put: XXX.X
6. Load the scale platform with the required weight and press ENTER	Weight calibration Please wait
7. Please wait without touching or shaking the scale until the calibration process is finished	Calibration factor: X.XXXXX
8. Press ENTER	Calibration Please clear the scale
9. Please remove weight from the scale platform	Rebooting Please wait
10. Please wait until the scale resumes normal operation	Health O Meter Pro Plus

## EXPLODED VIEW OF SCALE

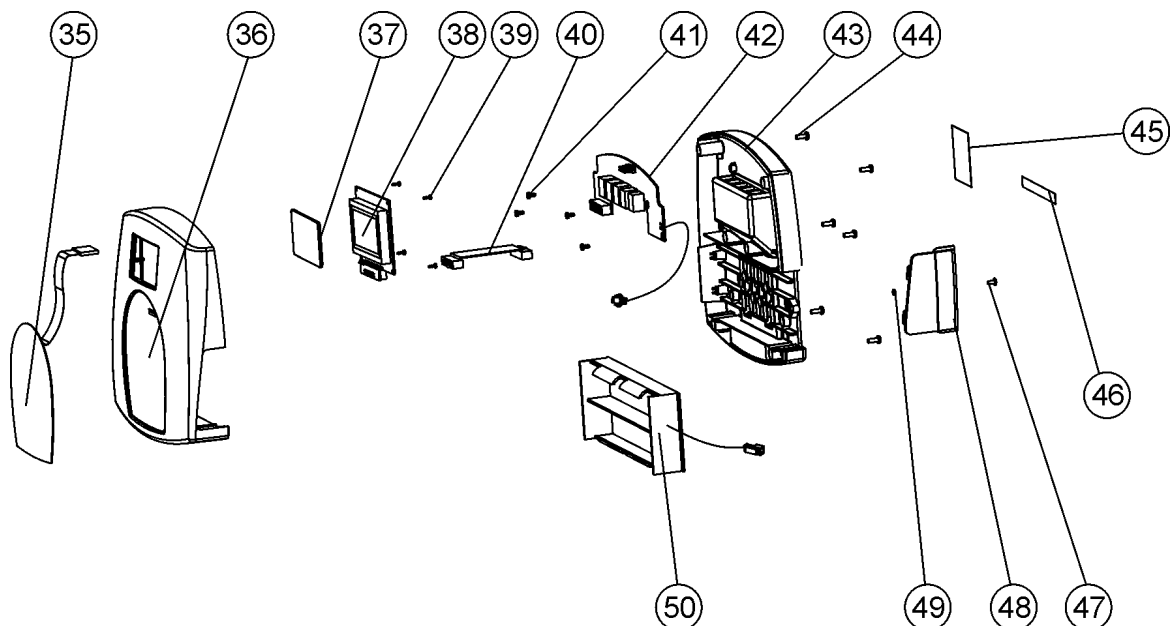

# EXPLODED VIEW OF SCALE (continue)

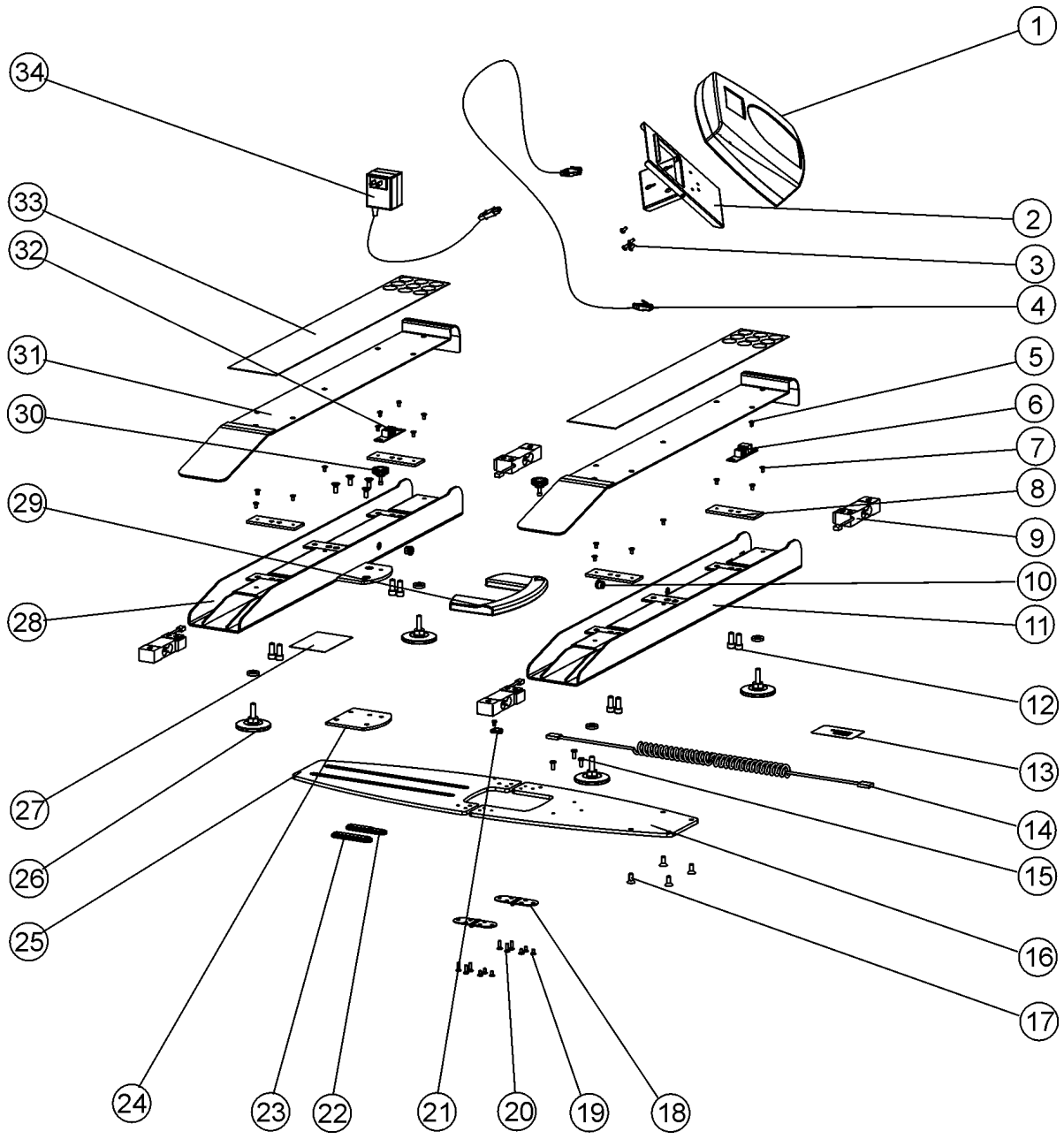

# PARTS LIST

Key No.	Part No.	Description	Qty.
1	1109402-0	DISPLAY ASSEMBLY	1
2	3824801-0	HEAD STAND	1
3		PHIL. PAN HEAD SCREW NC8-32*5/16"	4
4	2033702-0	MAIN BOARD TO CONNECTION CABLE	1
5		PHIL. PAN HEAD SCREW NC6-32*1/4"	5
6	2138902-0	RIGHT CONNECTION DIGITAL BOARD	1
7		COUNTERSUNK PHIL. HEAD SCREW M4*6	14
8	3825201-0	LOAD CELL MOUNTING PLATE	4
9	1304202-0	LOAD CELL	4
10	401298	STRAIN RELIEF BUSHING SR-5L-1	2
11		RIGHT RAIL BASE	1
12		SOCKET HEAD CAP SCREW NC5/16-18*3/4"	8
13		MODEL LABEL	1
14	2034001-0	RIGHT CONN. BOARD TO LEFT CON. CABLE	1
15		PHIL. PAN HEAD SCREW NC10-24*3/8"	3
16		CENTER SECTION B	1
17		SOCKET HEAD SCREW NC1/4-20*5/8"	8
18		HINGE - SUGATSUNE SMH-83	2
19		COUNTERSUNK PHIL. HEAD SCREW M4*8	6
20		COUNTERSUNK PHIL. HEAD SCREW M4*12	6
21	400117	PANDVIT CCS19-S8-C	1
22		LOCKING TV BAR	1
23		T BAR	1
24		DELTRIN SPACER	1
25		CENTER SECTION A	1
26	2267501-0	PLASTIC FOOT NC3/8" ASSEMBLY	4
27	3825801-0	LEXAN 0.5 SPACER	1
28		LEFT RAIL BASE	1
29	3824901-0	PLASTIC HANDLE	1
30	3825001-0	KNOB	1
31	3826001-0	RUNNER TEC ASSEMBLY	2
32	2138903-0	LEFT CONNECTION DIGITAL BOARD	1
33	3825901-0	MAT	2
34	420988	ADAPTER UNIT 6VDC 120VAC	1
35	411193	KEYPAD 600LB	1
36		HEAD TOP	1
37		LCD WINDOW	1
38		LCD BOARD	1
39		WN1412 CROSS HEAD SCREW K22L6	4
40		DISPLAY TO EAGLE P.C.B CABLE	1
41		WN1412 CROSS HEAD SCREW K30L6	4
42		EAGLE BOARD	1
43		HEAD BASE	1
44		PHIL. PAN HEAD SCREW NC6-32*3/8"	6
45		MODEL LABEL	1
46	3245801-0	INPUT/OUTPUT PORTS LABEL	1
47		PHIL. PAN HEAD SCREW NC4-40*1/4"	1
48	3822801-0	BATTERY COVER	1
49	400152	RUBBER O RING	1
50	2033801-0	BATTERY HOLDER	1

# WARRANTY

## LIMITED WARRANTY

### What does the Warranty Cover?

Pelstar LLC scales are warranted from date of purchase against defects of materials or in workmanship for a period of one (1) year. If product fails to function properly, return the product, freight prepaid and properly packed to Pelstar. See "To Get Warranty Service" below for instructions. If manufacturer determines that a defect of material or in workmanship exists, customers' sole remedy will be repair or replacement of scale at no charge. Replacement will be made with a new or remanufactured product or component. If the product is no longer available, replacement may be made with a similar product of equal or greater value. All parts including repaired and replaced parts are covered only for the original warranty period.

### Who is Covered?

The original purchaser of the product must have proof of purchase to receive warranty service. Pelstar dealers or retail stores selling Pelstar products do not have the right to alter, or modify or any way change the terms and conditions of this warranty.

### What is Excluded?

Your warranty does not cover normal wear of parts or damage resulting from any of the following: negligent use or misuse of the product, use on improper voltage or current, use contrary to the operating instruction, abuse including tampering, damage in transit, or unauthorized repair or alternations. Further, the warranty does not cover Acts of God, such as fire, flood, hurricanes and tornadoes. This warranty gives you specific legal rights, and you may also have other rights that vary from country to country, state to state, province to province or jurisdiction to jurisdiction.

### To get Warranty Service

**Make sure you keep your sales receipt or document showing proof of purchase.**

Call 1 (800) 638-3722 or 1 (708) 598-9100 to receive a return authorization number. Attach proof of purchase to your defective product along with your name, address, daytime telephone number and description of the problem. Carefully package the product and send with shipping and insurance prepaid to:

Pelstar LLC  
Attention R/A# \_\_\_\_\_  
Repair Department  
7400 W. 100th Place  
Bridgeview, IL 60455

If your scale is not covered by warranty, or has been damaged, an estimate of repair costs or replacement costs will be provided to you for approval prior to servicing or replacing.

**Pelstar LLC**

**7400 West 100th Place, Bridgeview IL 60455 • 1-800-638-3722 or 1-708-598-9100**

**[www.healthometermedical.com](http://www.healthometermedical.com)**

Health o meter ProPlus products are manufactured, designed and owned by Pelstar LLC.  
Health o meter® is a registered trademark of Sunbeam Products Inc., Boca Raton, FL 33431.  
ProPlus™ is a trademark of Pelstar LLC

**Patents Pending**

## Free Manuals Download Website

<http://myh66.com>

<http://usermanuals.us>

<http://www.somanuals.com>

<http://www.4manuals.cc>

<http://www.manual-lib.com>

<http://www.404manual.com>

<http://www.luxmanual.com>

<http://aubethermostatmanual.com>

Golf course search by state

<http://golfingnear.com>

Email search by domain

<http://emailbydomain.com>

Auto manuals search

<http://auto.somanuals.com>

TV manuals search

<http://tv.somanuals.com>