

ISSUE	DATE	REVISIONS
REV. A	July 2004	Honeywell template.
REV. B	December 2004	Formatting: pagination, minor edits.

Declaration of Conformity

A Rapid Eye Multi-Media LT unit (HRMxxxxxyzzzz) complies with Council Directives 89/336/EEC and 73/23/EEC.

These Euro Norms have been applied:

- EN50022: 1998, Radio frequency (RF) emissions;
- EN50130-4: 1995, Alarm system immunity with uninterruptible power supply (UPS);
- EN60950: 2000, Safety of information technology equipment;
- EN61000-3-2: 1995 Harmonics;
- EN61000-3-3: 1995, Voltage fluctuations (flicker).

FCC CFR 47, Part 15, Class B

This equipment has been tested and found to comply with the limits for a Class B digital device, pursuant to part 15 of the FCC Rules. These limits are designed to provide reasonable protection against harmful interference in a residential installation. This equipment generates, uses, and can radiate radio frequency energy and, if not installed and used in accordance with the instructions, may cause harmful interference to radio communications. However, there is no guarantee that interference will not occur in a particular installation.

If this equipment does cause harmful interference to radio or television reception, which can be determined by turning the equipment off and on, the user is encouraged to try to correct the interference by one or more of the following measures:

- reorient or relocate the receiving antenna
- increase the separation between the equipment and receiver
- connect the equipment into an outlet on a circuit different from that to which the receiver is connected
- consult the dealer or a radio/TV technician for help.

FCC Part 68

This equipment complies with Part 68 of the FCC rules. On the front cover of this equipment is a label that contains the FCC registration number and Ringer Equivalence Number (REN). You must provide this information to the telephone company when requested.

This equipment uses a USOC jack: RJ11.

This equipment may not be used on telephone-company-provided coin service. Connection to

party lines is subject to state tariffs. This equipment is hearing aid compatible.

Ringer Equivalence Number

A **Ringer Equivalence Number** (REN) assigned to each terminal device provides an indication of the maximum number of terminals allowed to be connected to a telephone interface. The termination on an interface may consist of any combination of devices subject only to the requirement that the sum of the Ringer Equivalence Numbers of all the devices does not exceed 5.

Industry Canada

This Class B digital apparatus complies with Canadian ICES-003.

Cet appareil numérique de classe B est conforme à la norme NMB-003 du Canada.

NOTICE: This equipment meets telecommunications network protective, operational and safety requirements as prescribed in the appropriate Terminal Equipment Technical Requirements document(s). This is confirmed by marking the equipment with the Industry Canada certification number. The Department does not guarantee the equipment will operate to the user's satisfaction.

Before installing this equipment, users should ensure that it is permissible to be connected to the facilities of the local telecommunications company. The equipment must also be installed using an acceptable method of connection. The customer should be aware that compliance with the above conditions may not prevent degradation of service in some situations.

Repairs to certified equipment should be coordinated by a representative designated by the supplier. Any repairs or alterations made by the user to this equipment, or equipment malfunctions, may give the telecommunications company to request the user to disconnect the equipment.

Users should ensure for their own protection that the electrical ground connections of the power utility, telephone lines and internal metallic water pipe system, if present, are connected together. This precaution may be particularly important in rural areas.

CAUTION: Users should not attempt to make such connections themselves but should contact appropriate electric inspection authority, or electrician, as appropriate.

RapidEye Multi-Media LT



Tested To Comply
With FCC Standards

FOR HOME OR OFFICE USE



The socket outlet shall be installed near
the equipment and be easily accessible.
This equipment shall be connected
to an earthed mains outlet.



Table of Contents

1	Walk-through	1-1
1.1	Overview	1-1
1.2	Walking Through.....	1-2
1.3	Where To, Next?	1-7
2	Field Work.....	2-1
2.1	Unpacking the Unit	2-1
2.2	Temperature.....	2-3
2.3	Reporting the Installation	2-4
2.4	Powering the Multi-Media Unit.....	2-4
2.5	Connecting a Camera.....	2-6
2.6	LocalView.....	2-7
2.7	Network Connection	2-9
2.8	Dial-up Connection	2-15
2.9	Field Testing a Connection.....	2-16
2.10	Damaged or Missing Goods.....	2-16
2.11	Upgrading Unit Software.....	2-17
3	Checking for Video.....	3-1
3.1	Multi Software	3-1
3.2	Using Admin.....	3-3
3.3	Using View to Connect.....	3-9
3.4	Results.....	3-17
4	Audio.....	4-1
4.1	Audio at a Multi-Media Site	4-1
4.2	Audio for Operators	4-3
5	Other Site Hardware	5-1
5.1	Securing a Multi-Media unit	5-1
5.2	Unit Hard Disk.....	5-2
5.3	Hardware Options.....	5-3
5.4	Connecting a PTZ Dome	5-4
5.5	Alarm Sensors.....	5-6
5.6	Inputs for Sensors.....	5-6
5.7	Control Outputs.....	5-8
5.8	System Monitoring.....	5-8
5.9	Point of Sale Hardware	5-10
5.10	External Modems	5-10
5.11	Port Use: Restrictions	5-11

6	Frequent Questions.....	6-1
6.1	Supporting an Installation.....	6-1
6.2	Background.....	6-2
7	Find-it.....	7-1
7.1	Knowledge Base.....	7-1
7.2	Tables.....	7-2
7.3	Illustrations.....	7-3
7.4	More FAQs.....	7-5
7.5	Site Information Checklist.....	7-8
8	Index.....	15

1 Walk-through

1.1 Overview

New to Multi-Media?

Installers who are new to Multi can benefit most from section 1.2: a walk-through of the key steps of a Rapid Eye Multi-Media unit installation.

Not new to Multi-Media?

Experienced installers can skip to sections:

- *2: Field Work*, shows procedures and reference material for Multi-Media unit installation.
- *5: Other Site Hardware*, shows optional hardware that you can add to a Rapid Eye site.

Software

The software operations for running a quick pilot are in section 3: *Checking for Video*, p. 3–1. For information about installing software and the Microsoft Windows patches needed to run Multi software, consult the *Operator Software Setup Instructions* for Rapid Eye Multi-Media units, part #K5401, in your documentation set.

LocalView and View software

A Multi-Media unit can be operated:

- **without a computer (PC), using LocalView.** Connect a VGA monitor and mouse to the unit.
- **with a PC, using View and Admin software.** For information about installing software and Microsoft Windows patches needed to run Multi software, consult the *Operator Software Setup Instructions* for Rapid Eye Multi-Media and Multi-Media LT units, available as a PDF after the installation of View and Admin on a PC.

Finding out more

To quickly locate

- frequently asked questions (FAQs), see section 6, on p. 6–1
- procedures (➤), tables or illustrations, there are handy *Find-its* in section 7, starting on p. 7–1
- the index, see p. 15.

1.2 Walking Through

Steps 1.2.1 to 1.2.10 offer a walk-through of a Multi installation. Procedures follow in section 2: *Field Work*, p. 2-1.

1.2.1 Cameras

➤1 Connect cameras (as many as 16) to the Multi-Media unit

Connect coaxial cable ...

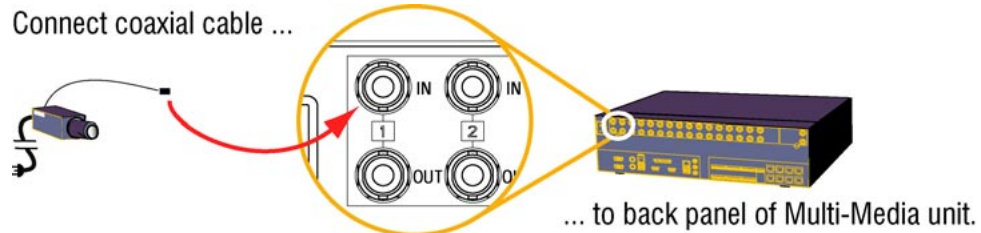

Fig. 1. Use the first available “IN” on the Multi back-panel for a camera.

For more detail

- 2.5: *Connecting a Camera*, p. 2-6

1.2.2 Communications

➤2 Connect the Multi-Media unit to a network or telephone line

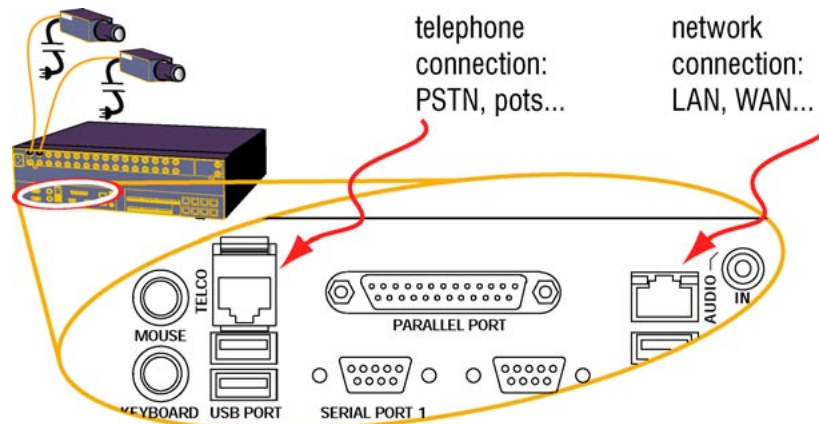

Fig. 2. Use standard connectors for network (LAN) or telephone line (TELCO).

For more detail

- 2.9: *Field Testing a Connection*, p. 2-16

1.2.3 Other Hardware

Ports for future use

The **USB** ports, **Printer** port, **VGA2** port, the **MIC IN** connector and the eight, numbered **RS-232** ports are for future use. Please do not connect USB devices or a printer to a Multi-Media unit.

For more detail

- section 5: *Other Site Hardware*. p. 5–1

1.2.4 Powering-up the Multi-Media unit

➤3 Supplying power to the unit and the cameras

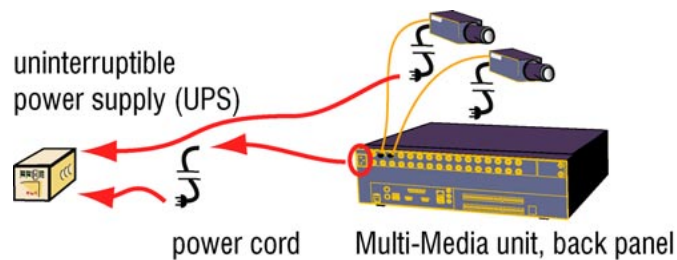

Fig. 3. Consider also plugging in cameras into the uninterruptible power supply used for a unit.

In Europe, a UPS is required to meet EN50130–4 Euro Norm.

Power switch

The power switch is located on the front of the unit, behind the locking grille, to the left of the small blue display screen.

1.2.5 Admin and View Software

➤4 Locate a personal computer (PC) running Multi software

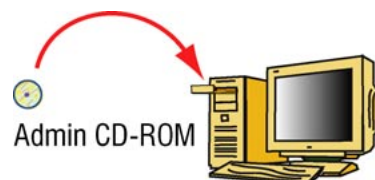

Figure 4. To install *Admin* and *View* software, run the Multi Admin CD-ROM. If Microsoft patches are needed for your Windows system, consult the *Operator Software Setup Instructions*, part #K5401.

1.2.6 A Database for Multi

➤5 Start Admin to create a Multi database



Fig. 5. Shortcut for Admin, on the Windows desktop

➤6 Log on to a Multi database, or create one using Admin



Fig. 6. The window for logging on can also be used to obtain an empty Multi central database.

1.2.7 Site Name

➤7 Using Admin, add a site

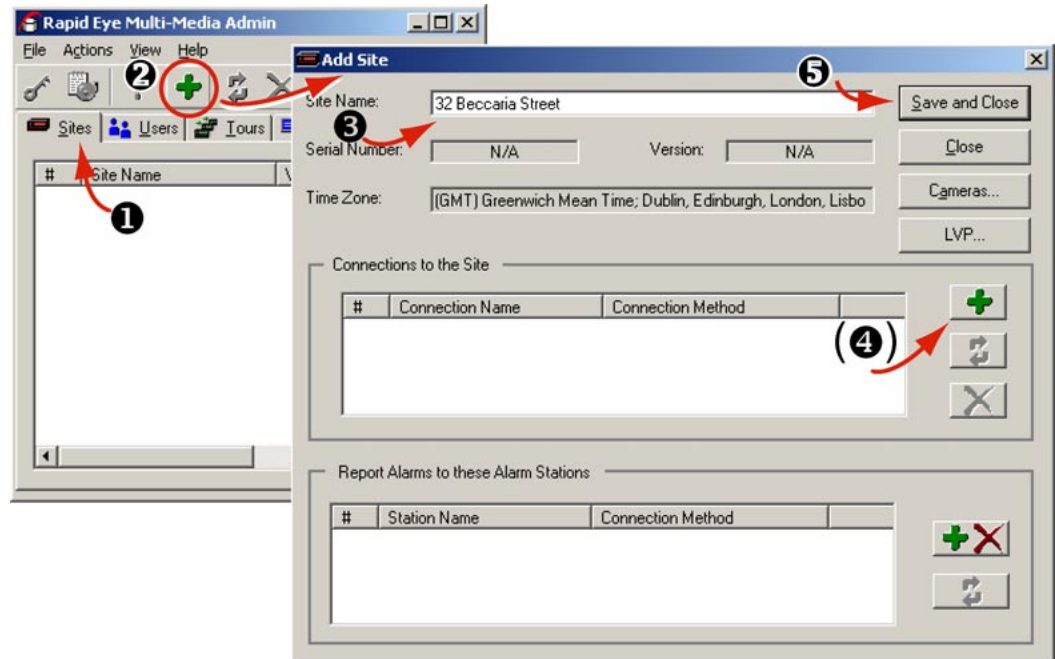

Fig. 7. From the Admin “Sites” tab, you can add, name, update and delete a site.

1.2.8 Type of Connection

➤8 Add information about the connection, and save it

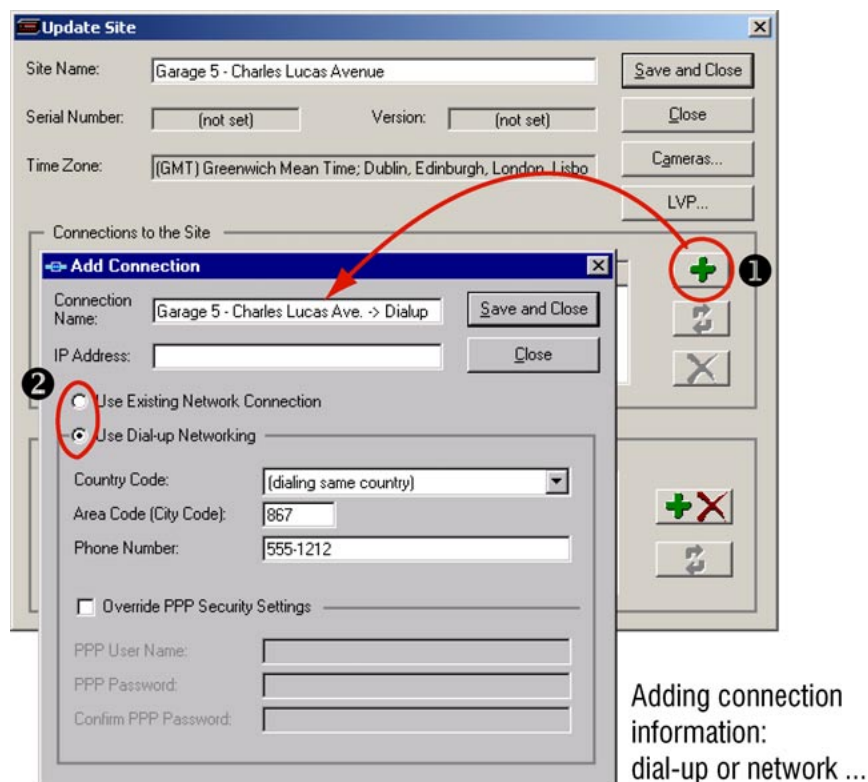

Fig. 8. Select a network or dial-up connection.

About connections

- 2.6: *LocalView*, p. 2–7
- 2.7: *Network Connection*, p. 2–9
- 2.8: *Dial-up Connection*, p. 2–15

1.2.9 Running View

➤9 To use View

- After installing View on your PC along with Admin, from your PC's desktop click the View shortcut icon, then log on.



Fig. 9. Shortcut for View, on the Windows desktop

➤ **10 Log on to View**

Clicking the database box shows the name of the Multi db.

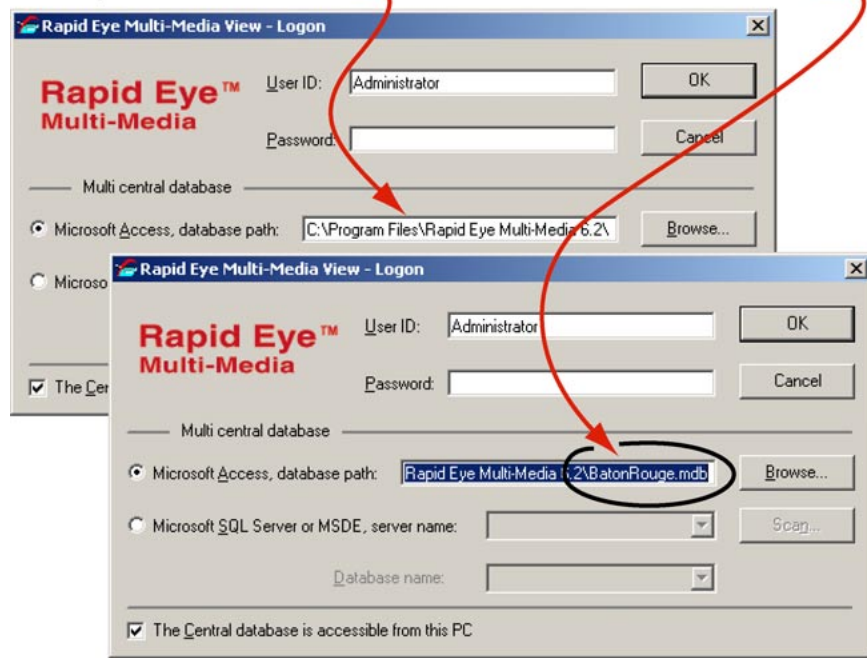

Fig. 10. Use the same database created earlier, using Admin; see fig. 6 on page 1–4.

1.2.10 Testing a Connection

➤ **11 Test the connection; use View to run a Maintenance session**

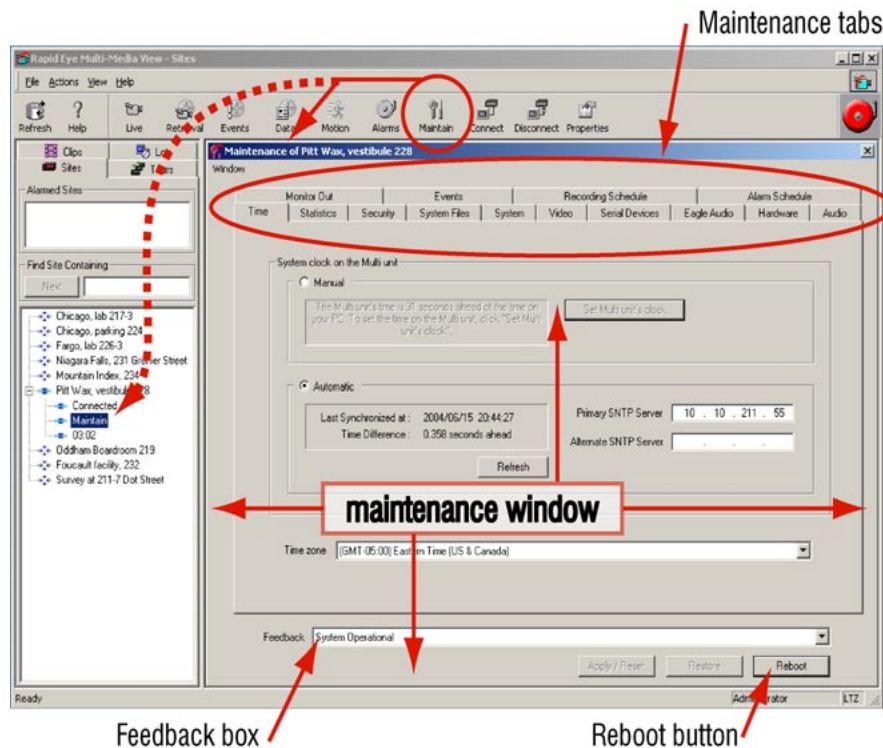

Fig. 11. A connection works if you see “System operational” in the Feedback box.

➤ 12 Start a Live session

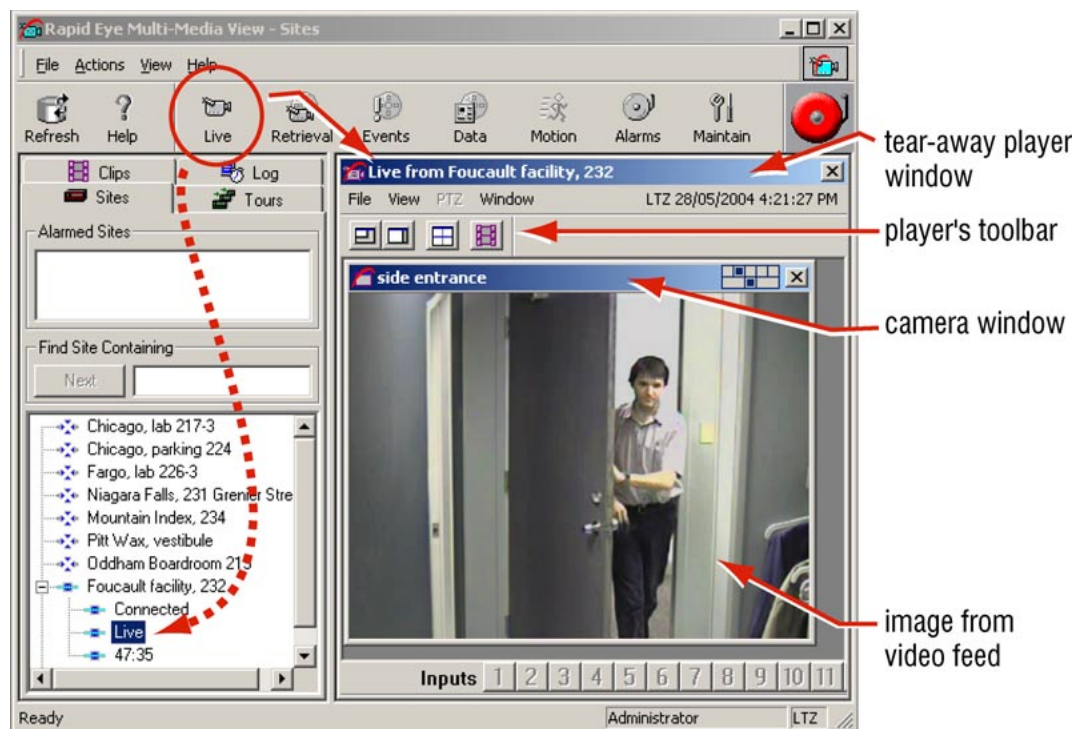

Fig. 12. Select a site on the **Sites** tab, then click **Live**.

1.3 Where To, Next?

In these installation instructions

Detailed procedures and reference material, for each step of the walk-through, start on p. 2-1.

1.3.1 For More Information...

Other Multi guides

Admin User Guide. Multi *Admin* software is used to enter data for connections to Multi-Media units, accounts for View operators and so on. Maintenance functions are explained, including security and how to configure optional hardware. The part number for the guide is K5403.

View User Guide. Describes how to use View software to best obtain video on your PC. Honeywell's part number for the guide is K5404.

Web site

To see more Honeywell products that can be used with Multi or to consult user guides of previous versions of this product, see:

- www.honeywellvideo.com

Background information

CCTV. For in-depth reference work about the field of closed-circuit television in a security setting, see:

- Kruegle, Herman, *CCTV Surveillance: Video practices and technology*, Butterworth–Heinemann, Newton (MA), 1995, ISBN 0-7506-9028-3, TK6680.K78.



Effective video feeds are a major component of any CCTV system.

Planning for camera position, distance from subject, angle and lighting can be as critical as operating your Multi-Media unit. For audio: planning microphone position, distance from subject and alarm bells can also be critical. Consult your camera and audio suppliers for optimal hardware setup.

Security. For ideas on how a defensible space can be enhanced by CCTV:

- Newman, Oscar, *Defensible Space: Crime Prevention through Urban Design*, Macmillan, New York, 1973, ASIN: 0020007507.

2 Field Work

Audience

Field technicians, tasked with the initial steps of an installation (see sections 1.2.1 and 1.2.2), will find the steps expanded and explained in more detail, in this section.

➤ 13 Road map to field work

- Unpack the unit.
- As you start connecting hardware to the Multi-Media unit, use the Site Information Checklist on p. 7–8, to take notes.
- Connect one or more cameras to the unit.
- According to the communications that you plan to use, connect the unit to: a telephone line, your network or both.
- Power up the camera(s) and the Multi-Media unit.
- *For network connections only*, to assign a TCP/IP address to the Multi-Media unit, use either:
 - (a) the LocalView interface (included) and a monitor (not included), or
 - (b) a PC (not included) and a null-modem cable (included).
- Field-test the connection to the unit.

Please do not remove factory seals on a Multi-Media unit.

Breaking them voids your warranty. There are no user-serviceable parts inside.

Field technicians, tasked with the initial steps of an installation (see sections 1.2.1 and 1.2.2), will find the steps expanded and explained in more detail, in this section.

2.1 Unpacking the Unit

➤ 14 To unpack a unit

1. Open the box and remove the Rapid Eye Multi-Media unit, the power cord and other items from the box. The contents are listed in table 1.
2. Remove the plastic bag that surrounds the unit.
3. Store the box and packaging materials.

Table 1
contents of Rapid Eye's hardware kit, WAMULTI5HWP4

item, one of each, unless otherwise noted	Part #
power cord	P8137
rack ears, brackets and screws, for optional mounting of unit	SARE2EARS
network cable (CAT-5), RJ45 connectors, 2m length	K9530
null-modem cable, serial, DB9 connectors, female	921400-05
straight through cable, DB9-pin, male connector, to DB9-pin, female connector	K0304
terminal block plug for FAULT RELAY, 4 positions, 3.5mm	K9531-4
terminal, block plugs (six), for ALARM inputs and CONTROL outputs, 8 positions, 3.5mm	K9531-8
screwdriver, slim, for terminal blocks	K9536
printed matter	
<i>Please Read This First!</i>	K9700
this document: <i>Multi-Media Unit Installation Instructions</i>	K9696

Table 2
contents of Rapid Eye's software kit, WAMULTI5SWP4

Item, one of each, unless otherwise noted	Part #
mouse, two-button, PS/2 compatible	K9258
mouse pad	K0007V1
CD, Rapid Eye Multi-Media software	HRM6ADMIN
printed matter	
<i>Operator Software Setup Instructions</i>	K5401
<i>Admin User Guide</i>	K5403
<i>View User Guide</i>	K5404

2.1.1

Rear Panel Reference

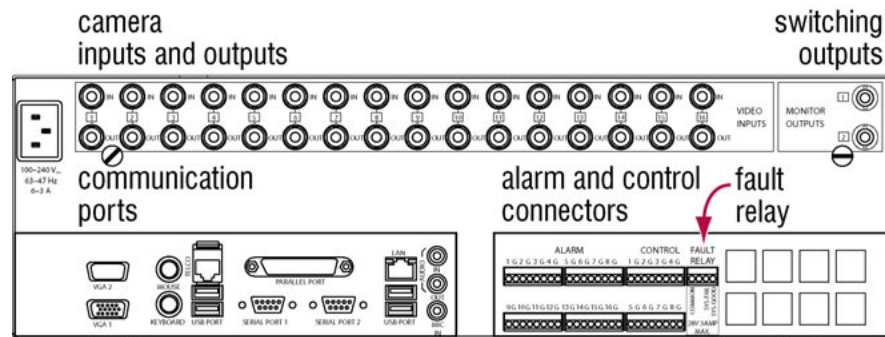

Fig. 13. Rear panel of a Multi-Media unit. The connectors are listed in table 3.

Table 3
Panel connectors

Connector Label	Description
SERIAL PORTS	General-purpose serial ports, DB9 connector.
VIDEO INPUTS – IN	BNC connectors for video signal cable from the cameras in a CCTV system. A Multi-Media unit has 16 video input connections.
VIDEO INPUTS – OUT	BNC connectors to relay a video feed to either a CCTV, NTSC or PAL monitor, VCR, or other device. The outs are capped for delivery.
MONITOR OUTPUT 1	BNC connector; can be set to produce test pattern or a camera tour. Also called “Video spot out” on previous version of unit.
MONITOR OUTPUT 2	BNC connector; inoperative for this release.
MOUSE	For standard mouse (supplied)
KEYBOARD	For keyboard (optional)
TELCO	RJ-11 connector to Multi-Media unit’s modem
USB PORT	Inoperative.
PARALLEL PORT	Inoperative.
LAN	RJ-45 connector to unit’s 10/100 BT network card
AUDIO IN/OUT	Soundcard connectors
MIC IN	DISABLED; use AUDIO IN.
ALARM INPUTS	Screw terminal connectors for input and ground* connections, to interface with devices such as alarms. TTL type: minimum high level of +2.4 volts; maximum low level of +0.4 volts.
CONTROL OUTPUTS	Screw terminal connectors for output and ground* connections, to interface with devices such as: lights, sirens, locks, and so on. TTL type. The outputs do not directly drive devices; they control relays that do so.

* Control I/O must be referenced to the ground of the Multi-Media unit.

USB port and Printer port

The USB port and Printer port at the back of the REMM unit are for future use.

Do not connect USB devices or a printer to a Multi-Media unit.

2.2 Temperature

Honeywell recommends that a unit be operated in a non-condensing environment, in temperatures ranging from 40° F to 104°F (or 5°C to 40°C).

2.3 Reporting the Installation

Flexibility

As you start connecting hardware to the Multi-Media unit, Honeywell recommends that installers take notes in a form similar to the one provided in 7.5: Site Information, on p. 7–8. Include a record of the hardware connected to the Multi-Media unit and of use of LocalView to make changes to the Rapid Eye site's configuration.

To whom...

Direct the report to the:

- **Multi SA.** An organization's *Multi system administrator* (Multi SA), responsible for use of the *Admin* software.
- and/or -
- **network administrator.** The installer may need to contact the organization's network administrator, depending on a Multi system's sensitivity, complexity, size, and the Multi SA's knowledge of computers and networks.

Content of installation report

The report contains information needed for configuring the site(s) using *Admin* and *View* software.

The installation report can list:

- telephone number or IP addresses assigned to Rapid Eye sites
- information about the cameras (color, PTZ, and so on)
- use of other hardware (gates, alarms and so on) connected to the Multi-Media unit's input(s) or output(s).

2.4 Powering the Multi-Media Unit

Power requirement

A Multi-Media unit can auto-range:

- 100–240 V~, 63–47 Hz, 6–3 A

For many cameras in a permanent installation, you can use a power supply such as an APS 2404UL (4 cameras) or APS 2416UL (16 cameras).

Uninterruptible power supply

To allow time for a safe power-down, a UPS should guarantee 300 watts of power for each Multi-Media unit, for at least 30 minutes.

In Europe, a UPS is required to meet EN50130–4.

UPS: remember the cameras

Powering the *cameras* (or their power supply) from a UPS ensures that the Multi-Media unit can continue to record video during a power outage, whether the outage is due to your utility or to a criminal act.



Honeywell recommends that a line conditioning uninterruptible power supply (UPS) be used with the Multi-Media unit and the cameras connected to the unit.

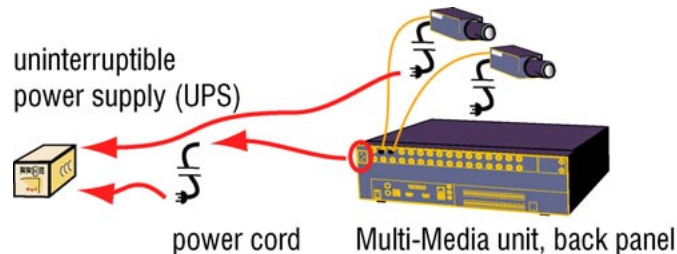

Fig. 14. Plugging-in a Multi-Media unit.

Without a UPS?

When a UPS is not used, the Multi-Media unit should be connected to a dedicated ground circuit. The outlet and breaker box should be marked as such. Nothing else should be plugged into this circuit.

2.4.1**Powering Up and Down****Wait after turning on a unit**

During the two minutes a REMM unit needs to initialize, it is good practice to **not** turn it off.

A “unit recovery” process can be triggered if the unit is turned off before initialization is complete. The end of the initialization is signaled by a **double-beep** from the unit.

➤15 The power up sequence recommended by Honeywell

1. Plug the Multi-Media unit and its cameras into a power source, preferably an uninterruptible power supply (UPS).
2. Turn on camera(s) and other hardware, connected to the unit.
3. Turn on the Multi-Media unit.

➤16 The power down sequence

1. Press and hold the power switch on the front of the Multi-Media unit for up to five seconds.
2. Unplug the Multi-Media unit from the uninterruptible power supply (UPS) or wall outlet.
3. Power down the camera(s) and/or other hardware.
4. Power down the UPS, if in use.

If cameras are turned on *after* the Multi-Media unit, they will not be auto-detected by the unit.

2.4.2 Unit Recovery

Unit recovery is an internal diagnostic that seldom occurs and cannot be interrupted, even by powering down a unit. A unit recovery can take well over two hours on units with a large storage capacity; see table 4. If unit recovery occurs repeatedly, contact Honeywell technical support.

Table 4

Time needed for a Multi-Media unit recovery

nominal storage* (camera-day)	time† (minute)
500	80
1000	160
2000	320
4500*	640

* A unit's nominal storage is indicated as part of the model number. For example: HRM60CD**4500**, "4500" is the number for storage.

† Values are approximate. During a unit recovery, a View operator can only run a maintenance session on the Multi-Media unit, to check the **Feedback** box for the "Recovering storage, *n* % completed" message.

2.5 Connecting a Camera

Honeywell recommends powering down a unit before connecting hardware to it. See 2.4.1: *Powering Up and Down*, p. 2–5.

Connector

The BNC connector's low signal loss, ease of twist-on installation, and small size, make it a common connector for CCTV connections. Honeywell recommends using a solder- or crimp-type connector. Video is quite sensitive to bad connectors; **do not use** screw-type connectors. These can seriously compromise a unit's performance.

Connect coaxial cable ...

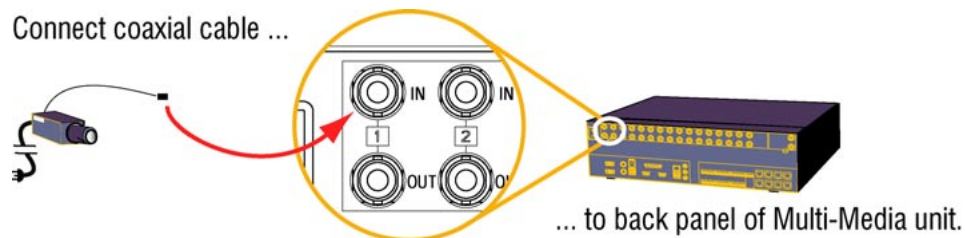

Fig. 15. Connect each camera to a different camera input (an "IN", in the VIDEO INPUTS section), on the back-panel.

Rapid Dome or Rapid Dome Gold dome systems

With Rapid Dome or Rapid Dome Gold dome systems, using twisted pair transmission, Honeywell recommends that passive-to-passive transmission distances be no more than 500 feet (154 meters). For greater distance, please use an active receiver product such as an ATP652R.

Securing a camera

Forethought about poor camera angles and the possibility of tampering with cameras or vandalism can help to assist police if an area becomes a crime scene, for optimal gathering of evidence, whether for corporate use, or for use of video in a court of law.

Lens selection and angle of the camera can be critical to the usefulness of images obtained in a closed circuit television (CCTV) system.

When planning where to place video cameras, Honeywell suggests that your planning authority consider:

- dealing with environmental lighting situations that can render a system ineffective: direct sunshine or other strong lighting, darkness and so on.
- environmental factors that can hamper cameras or the lens of cameras: dust, condensation, grease (common in food preparation areas), excessive heat or cold.
- working around camera blind spots due to: architecture, mobile equipment, vehicle docking, construction and so on

Reference

The details of camera lens selection, camera angle, maintenance and so on, are beyond the scope of this guide. For an in-depth reference about the field of closed-circuit television in a security setting, see:

- **Kruegle**, Herman, *CCTV Surveillance: Video practices and technology*, Butterworth–Heinemann, Newton (MA), 1995, ISBN 0-7506-9028-3, TK6680.K78

2.6 LocalView

Hardware

LocalView is available by connecting a VGA monitor and a mouse directly to the REMM unit. LocalView automatically starts when the REMM unit is powered up. An online help facility is included with LocalView. To use LocalView, you need only the mouse supplied with the REMM unit – a keyboard is not required.

Honeywell recommends powering down a unit before connecting hardware to it. See 2.4.1: *Powering Up and Down*, p. 2–5.

PTZ configuration and control are not currently supported in LocalView. PTZ configuration and control are fully supported when using View software.

Functions

Using LocalView, you can:

- perform basic system setup functions such as: configuring network settings, including the unit's IP address
- perform camera setup: name, type, recording rate and recording quality
- configure system clock: date, time and time zone

- review and search the system log
- record and monitor live video, audio or data
- make and view a video-clip that includes audio and data
- copy a video-clip to the unit's CD-RW drive; a drive is an option on REMM units
- set up a camera tour, using the Cycle feature.
- monitor a video feed at high resolution.

LocalView help on operator's PC

LocalView's online help is available in a small, standalone application for an operator's PC. It is on the *Admin and View* CD and on the *Upgrade* CD, in the *RU* folder. Look for: *LocalView Help.exe*. The files are HTML; they are read using an internet browser.

Monitors

VGA. For using LocalView, a VGA monitor can be plugged directly into a Multi-Media unit. The software is designed for a resolution of 800 x 600.

Select a VGA monitor to run LocalView only if the monitor supports a resolution of 800 × 600.

NTSC. To use LocalView on an NTSC television set or monitor, you need a VGA- to-NTSC converter. Text labels on such equipment may be harder to read than on a VGA monitor.

PAL. To use LocalView on a PAL television set or monitor, you need a VGA- to-PAL converter. Text labels on such equipment may be harder to read than on a VGA monitor.



Placing a monitor or other equipment directly on top of the Multi-Media unit is not recommended.

Recommended media

For recording clips using the CD-RW drive on a Multi-Media unit, Honeywell recommends that only *recordable* compact discs be used (CD-R).



Do not use re-writable compact discs (CD-RW) or recordable digital video discs (R-DVD) to store Multi-Media video clips.

LocalView passwords

LocalView passwords are also explained in LocalView's online help system and briefly discussed in this guide and in the *Admin User Guide*.

➤ 17 To enable the locking of a LocalView functions

1. Using *LocalView*, click the **Setup** tab. Sub-tabs appear.
2. On the **System** sub-tab, under "Security Passwords", click the checkboxes for either: **Cycle**, **Setup**, or both, so that they show a checkmark.

➤ **18 To change a LocalView password**

1. After locking a LocalView function, as explained in procedure ➤17, click that function's **Password** button. A window appears showing a virtual keypad.
2. Using the virtual keypad, enter a number. The password's length can be between 4 and 10 digits.
3. Click **OK**.



Please make a note of passwords. A lost password can make the LocalView interface unchangeable.

Default LocalView passwords

To lock a Cycle: **1111**.

To lock the LocalView setup: **9999**; this password can be used to also unlock a cycle of the Live tabs.

To lock the availability of making a clip: **1111**.

The LocalView passwords have no effect on other passwords, set using Admin software. See the *Admin User Guide* for procedures involving other passwords.

Very low recording rates

Table 5 shows some limits that a Multi SA needs to impose on cycle times for low recording rates *only when using LocalView*.

Table 5

Restriction for LocalView cycle times when setting low recording rates

recording rate (fps)	lowest cycle time (sec.)
0.25	16
0.5	8
1.0	4

2.7 Network Connection

Overview

You may not need to assign an IP address to a unit if your network is enabled for Dynamic Host Configuration Protocol (DHCP).

Networks with DHCP

Multi-Media units can be enabled as DHCP clients; DHCP is OFF by default. After enabling DHCP, power-down a unit connected to the network and power-up. See the *Admin User Guide* for detailed procedures.

A network administrator has the option of assigning a reserved IP address to a Multi-Media unit, instead of a "computer name". In that case, the unit's default IP address can be used. You have the option of assigning a different static IP address to the unit using the procedures for networks without DHCP, below.



Within DHCP without DNS, an assigned IP address needs to be reserved or it may change.

Plan to let the network's administrator as well as the Multi SA know of the unit's installation; after a unit is rebooted or reset, a new DHCP address is assigned to it and communication to the unit could be hampered if wrongly configured.

For a network without DHCP

There are two methods of setting a static IP address on a Multi-Media unit. You can do so by using either:

- **LocalView.** Software available on Multi-Media units. To use, LocalView software, connect a monitor (not supplied) and a mouse (supplied) to the unit; connecting a keyboard is optional.
- **PC.** When using a PC onsite, procedures ➤20 to ➤25 are used.

Setting an IP address is only needed for a connection to a network.

Do not use these procedures on a unit that only has a dial-up connection.

2.7.1 Using LocalView Onsite

➤19 To assign an IP address to a unit using LocalView

If needed, repeat steps 3 to 6 for the **Network Mask** and **Gateway**.

1. Connect a monitor and mouse to a Multi-Media unit. *LocalView* appears on the monitor while the unit is on.
2. Using the mouse connected to the Multi-Media unit, click the **Setup** tab of LocalView. Sub-tabs appear.
3. On the **System** sub-tab, under "Network Settings", click the **IP Address** field. A window appears showing a virtual keypad.
4. Click the keys of the virtual keypad to enter the IP address.
5. Click **OK**.

What next?

After making these settings, someone needs to use Admin software to duplicate the settings in a Multi database, before a View software operator can connect to the unit through a network.

2.7.2 Using a PC Onsite

Procedures >20 to >25 explain how to use a PC onsite.

>20 To connect a null-modem cable

1. Power off the Multi-Media unit.
2. Connect the 9-pin (or 25-pin) female connector of a *null modem* cable to one of the PC's serial ports. Connect the other 9-pin female connector to the RS-232 **Port 2** connector at the back of the unit.

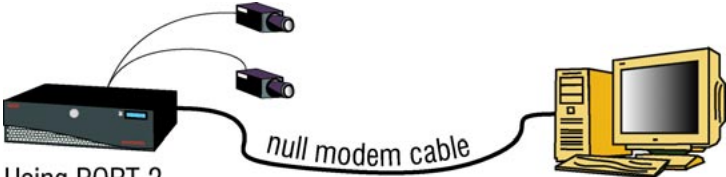

Using PORT 2 of a Rapid Eye Multi-Media unit, to connect ...
 ... to a serial port on a PC running HyperTerminal.

Fig. 16. Temporary use of a PC onsite.

A null-modem cable comes with your Multi-Media unit.

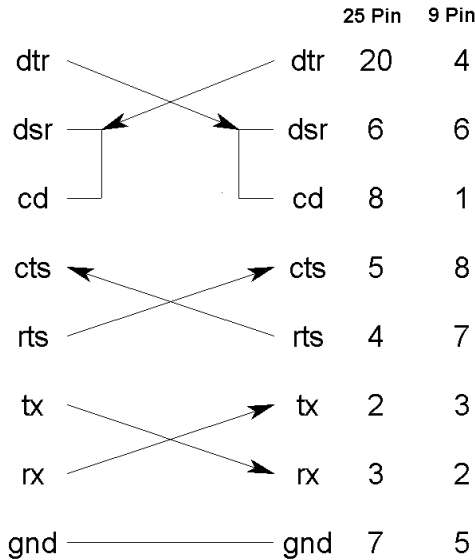

Fig. 17. Wiring diagram of a null modem cable

>21 To setup a terminal program

1. On the PC connected to a Multi-Media unit, start a terminal session. You can use a program such as *HyperTerminal*—bundled with Microsoft *Windows*. The commands for launching *HyperTerminal* are listed in table 6. The terminal session is used to send commands to the *Multi-Media Shell* software on the unit. A dialog appears, similar to the *Connection Description* in figure 18.

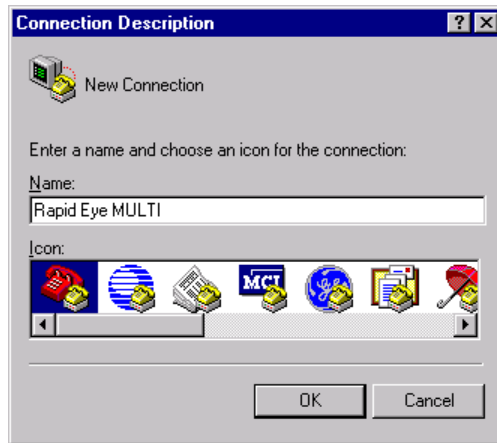

Fig. 18. Naming a connection, using *HyperTerminal*

2. In the *Connection Description* dialog, type “Rapid Eye Multi-Media” (or similar) in the **Name** field.
3. Click **OK**. A *Connect To* dialog appears. See figure 19.
4. Using the *Connect To* dialog, select the Workstation's COM port number that is connected to the null modem cable, by using the arrow next to the **Connect using** field.
5. Click **OK**. The *COM Properties* dialog box is displayed.



Fig. 19. Indicating a PC's COM Port, using *HyperTerminal*

6. In the *COM Properties* dialog box, set the Terminal program to the values listed in table 7.
7. Click **OK**.

Table 6
Commands for launching *HyperTerminal*

Windows	Click [Start] and point to then click
98	Programs, Accessories, Communications, <i>HyperTerminal</i>	Hypertrm.exe icon
NT	Programs, Accessories, <i>HyperTerminal</i>	<i>HyperTerminal</i>
2000	Start, Programs, Accessories, Communications	<i>HyperTerminal</i>
XP: XP style	Start, All Programs, Accessories, Communications	<i>HyperTerminal</i>
XP: classic style	Start, Programs, Accessories, Communications	<i>HyperTerminal</i>

Table 7
Settings for *HyperTerminal* communications session

Parameter	Value
Bits per second	9600
Data bits	8
Parity	None
Stop bits	1
Flow control	Hardware

➤22 To use the Multi-Media Shell

1. While watching the terminal program running on the PC, turn the Multi-Media unit on. For ten seconds, the terminal program displays: "HIT ENTER TO KEEP SHELL RUNNING".
2. Press **Enter** within ten seconds. After ten seconds, the Multi-Media unit bypasses the Multi-Media Shell and continues its initialization.

After 10 minutes of inactivity, the Multi-Media Shell times out.
To return to it, turn the Multi-Media unit off, then use procedure 22.

➤23 To assign an IP address to the Multi-Media unit

1. Type "ip=" (without the quotation marks) followed by the network address assigned to the Multi-Media unit by your network administrator. Press **Enter**.
2. If needed, use "gateway=" and "netmask=" Multi-Media Shell commands to set them to values assigned by your network administrator. Press **Enter** after each command's data.

Table 8
Default Multi network settings

Field Name	Default Address	Shell command
IP Addr	172.25.2.1	ip=
Subnet Mask	255.255.0.0	netmask=
Gateway	172.25.100.4	gateway=

Multi Shell Reference

While using the shell, what you type is saved as soon as you press the **Enter** key. To change a setting, type its command, as listed in table 9.

Table 9
Multi-Media Shell commands

Command	Result
?	Displays a list of commands.
cls	Clears the Terminal screen.
quit or q	Quits the Multi-Media Shell and starts the Multi video unit in its normal mode of operation.
show	Displays current LAN and PPP settings.
ip= gateway= netmask=	IP: LAN settings
comport=	Port offering a connection to the Multi-Media unit's modem. Values: none , port1 , port2 , or internal .
baudrate=	Transfer rate from the Multi-Media unit to the modem. Values: 9600 , 19200 , 38400 , 57600 , or 115200 .
modem prefix= modem init= modem dial=	Modem dialing string commands. Your modem documentation lists acceptable values.
local= host=	PPP: temporary IP settings for TCP/IP network communications, established between the local (Multi-Media unit) and the host (PC) during a <i>dial-up</i> connection.
timeout=	Time allotted between alarm callback attempts on dial-up connections. Value: from 0 to 999 seconds.
Recover	Restores unit software to previous version. System, configuration, and application files are restored from the backup directory. After you enter this command, the Multi-Media unit is automatically rebooted.

To start the Multi-Media Shell, see 2.7.2: *Using a PC Onsite*.

➤24 To quit the program

- Quit the Multi-Media Shell by typing "q" and pressing **Enter**.

After 10 minutes of inactivity, the Multi-Media Shell times out.

To return to it, turn the Multi-Media unit off, then use procedure 22.

➤ **25 To return to the Multi-Media Shell after a time out**

- Turn the Multi-Media unit off, wait five seconds, then turn the unit on again and go back to the previous procedures.

The commands for the Multi-Media Shell are listed above in the *Multi Shell Reference*, on the next page.

2.8 Dial-up Connection

For Telco communication, a data-grade (fax) telephone line is preferable to a standard line. Special features, such as call waiting, should not be available to a telephone line used by a Multi-Media unit.

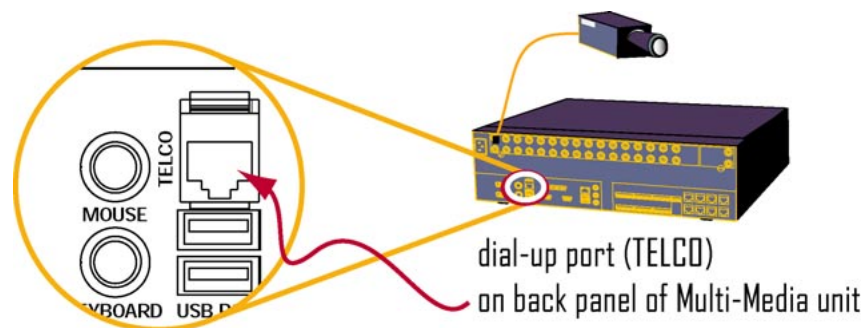

Fig. 20. Detail of “TELCO” port, used for dial-up connection.

Honeywell recommends powering down a unit before connecting hardware to it.

See 2.4.1: *Powering Up and Down*, p. 2–5.

➤ **26 To connect the Multi-Media unit to a telephone line jack**

1. Using a standard telephone cable with RJ-11 connectors, plug one connector into the unit’s TELCO port; see figure 20.
2. Plug the other connector in a telephone outlet.

Connect the unit to a telephone line only if a dial-up connection is used to communicate with the Multi-Media unit. For a network connection, please skip to section 2.7: *Network Connection*.

What next?

You are ready to power-up the camera(s) and unit as explained in section 2.4: *Powering the Multi-Media Unit*, on p. 2–4.

2.8.1 Modem Reference

The default settings for the modem in a Multi-Media unit are listed in table 10. Consult the organization's Network Administrator or Multi System Administrator (Multi SA) if this modem's settings need to be changed.

Table 10
Default modem settings

Field Name	Value
TELCO Port	Internal or Port 1
Baud	115,200
Wait	60
Prefix	AT
Initialization	Z
Dialing	D

2.9 Field Testing a Connection

➤ **27 To field-test a dial-up connection**

- Using a standard telephone line, dial the Multi-Media unit's number to hear if you can reach its modem.

➤ **28 To field-test a network connection**

- PING the IP address of the unit.

2.10 Damaged or Missing Goods

➤ **29 To deal with a damaged Multi-Media unit**

1. Inspect the unit for any other damage or missing parts. See table 1, above, for a checklist of the contents.
2. Make a note of the unit's serial number, located on the underside of the unit.
3. Call your Rapid Eye supplier to describe the problem and to tell them the unit's serial number. As required, the supplier assigns a Return Authorization (RA) number to the unit.
4. Make a note of the RA.
5. Re-pack the unit, along with the other contents.
6. Prominently display the RA on the shipping container.
7. Return the packaged unit to the location specified by your supplier.

2.11 Upgrading Unit Software

Upgrade CD-ROM

Onsite, you can upgrade Multi-Media units equipped with a CD-ROM drive.

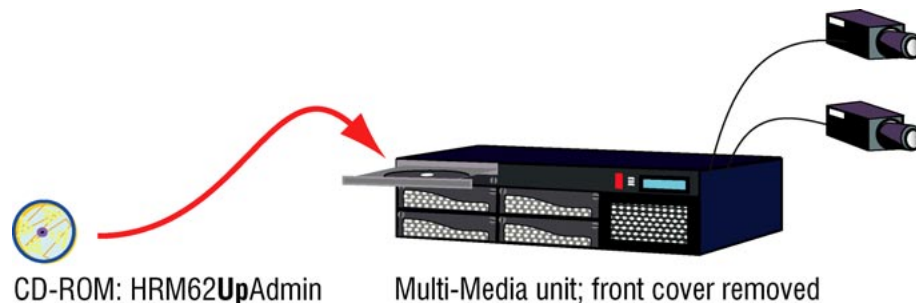

Fig. 21. Upgrading a unit in the field.

➤30 To upgrade a Multi-Media unit's software, onsite

1. Remove the front cover of the Multi-Media unit; if the cover is locked, use the key supplied with the unit.
2. Press the button on the CD-RW drive. A tray slides out.
3. Drop the CD-ROM identified as **HRM62UPADMIN** into the tray and press it into position. See figure 21.
4. Shut the CD-RW's tray.
5. Turn the unit off, by pressing the red POWER button while the CD-ROM remains *in the unit*.
6. Power-up the unit.
7. Check the unit's blue LCD; as the unit starts up, a set of messages appear:
 - "Honeywell Startup Shell", "*Do Not Restart* Upgrading Unit", "Upgrade Complete. Restarting Unit*", "Honeywell Startup Shell".
 - The final message depends on the unit's hardware.
For units holding a Pentium 3 processor: "Rapid Eye Multi-Media V5.2";
for units holding a Pentium 4 processor: "Rapid Eye Multi-Media V6.2".
8. The unit is operational. Press the button on the CD-RW drive and remove the CD-ROM from the tray.
9. Shut the CD-RW's tray.
10. Replace the front cover on the unit.

Multi-Media unit without a CD-RW drive

Multi-Media *units* without a CD drive can be upgraded from a View Operator's PC.

You can also upgrade in the field by connecting a PC directly to the unit, using a null-modem cable.

Please continue.

3 Checking for Video

Audience

After installers have field-tested connections (see 2.9 on p. 2–16), the next steps involve working with Multi software from a PC. Your organization’s Multi SA needs to establish that video can be obtained on a PC. The *road map for using Multi software...* outlines the work.

➤ 3.1 Road map for using Multi software to obtain video

1. Locate a PC on which *Admin* and *View* have been installed. See 3.1: *Multi Software*.
2. Use *Admin* software to:
 - create and log on to an empty Multi central database
 - name the Rapid Eye site being tested
 - add connection information about the Rapid Eye site.
3. Use *View* software to:
 - log on to the Multi central database
 - run a “Maintenance” session for the Rapid Eye site, to check the type of camera(s) that were auto-detected by the Multi-Media unit
 - run a “Live” session to obtain video.

Why check a connection?

It is useful to establish that the hardware and software installations are in good working order **before** securing the system (with passwords, user profiles and so on) and establishing a user base (by creating user accounts).

3.1 Multi Software

When you run a Multi CD-ROM, the software detects if any Microsoft patches need to be added to your Windows system. All of these patches are available on Microsoft’s web site. For specifics, please consult the *Operator Software Setup Instructions* for Rapid Eye Multi-Media units, part K5401.

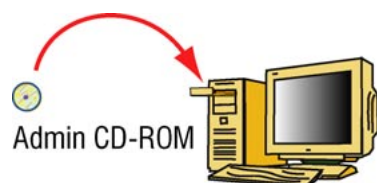

Fig. 22. In organizations where security is a high priority, *Admin* is not installed on all PCs. The PCs of *View* operators do not need *Admin*.

➤ **32 To install Multi software**

1. Run the *Rapid Eye MULTI ADMIN and VIEW* CD-ROM. The installation starts automatically.



You need Administrator rights to install View to run on Windows 2000, NT or XP.
The installation program cannot update the registry if a user without this right is running Windows.

2. The “Rapid Eye MULTI” pane is displayed, followed by a message, asking if a modem will be used to connect to video units in your system. See your network administrator if you are unsure.
 - **Yes.** For a telephone line connection, click “yes”.
 - **No.** For a network connection, click “no”.
3. The Windows operating system is checked for any missing Microsoft components that are required to run Multi, or for older versions of Multi that must be removed. Either:
 - a **Welcome** message appears. You can click **Next >** and go to step 4.
 - The **installation stops** due to a missing Microsoft component on the PC. A message appears listing the missing component(s). Make a note of the component(s) listed in the message. Click **OK**, stop using this procedure and see the *Operator Software Setup Instructions* for Rapid Eye Multi-Media units, part #K5401.
4. A *Software License Agreement* appears. If you agree with the licensing agreement, click **Yes**.
5. Your name and business are displayed. Correct the information if needed, and then click **Yes**.
6. The installation program selects a drive and folder to install the Multi files. Either:
 - accept the location and click **Next >**.
 - select a different folder; click **Browse**. Use Windows to select a drive and folder. Click **Next >**.
7. It takes a few seconds to copy the Multi files to the PC. “Setup Complete” appears at the end of the process. Click **Finish**. Multi adds icons on your desktop: one for *Admin* and one for *View*.

Installing Multi software is also explained in the *Operator Software Setup Instructions*.

You have the option of installing the software before or after the fieldwork, described in section 2, above.

Some versions of Windows need you to restart the PC.

3.2 Using Admin

➤33 To continue installing a Multi-Media unit ...

Before you can check for video, a record of a Rapid Eye site and connection is made, using *Admin*. A *site* is a term used for a unit, with its cameras or other hardware.



Fig. 23. Icon for Admin on the Windows desktop

Creating an empty Multi db

For installation purposes, you have the option of creating an empty db *on the fly*, as you log on to *Admin*. A Microsoft Access software template is used. You do *not need* a copy of Access installed on the PC to use this feature; everything you need is included with your copy of Rapid Eye Multi software. Only one Multi database (Multi db) is needed for many sites.

You do not need to create a db each time that you log on.



Choose a name for your Multi db that avoids:

- (a) a name that you will need for a *user* of that Multi db; or
- (b) "Administrator". It is the name of the default user in any Multi db. A Multi db with the same name as a user account causes an error when *View* is started.

Upgrading a Multi database

You can use a populated SQL or MS-Access db for testing an installation. Microsoft Access-based Multi databases, created using an older version, are upgraded on the fly; one prompt at logon and conversion is automatic. For specifics, see the *Multi: Software Installation Instructions* and the *Multi: Admin User Guide*.

3.2.1 Running Admin

Logging on to Admin

Three pieces of information are needed:

- **user account.** Use the "Administrator" account. It has the right to use all of the functions in Admin and View. It also has access to every Rapid Eye site in your system.
- **password.** By default, there is no password for the Administrator account. You can add a password after testing is complete. Account and system passwords are explained and discussed in the *Admin User Guide*.
- and -
- **database.** For testing, you can obtain an empty database as explained below, in section 3.2.2.

After adding security

Changing the password to the “Administrator” account is among a Multi SA’s first tasks to secure a Multi system from tampering. After adding a password, your Multi SA can create accounts and identify Multi sites.

Typing text in the Multi central database box before clicking OK, displays a “Create Database” dialogue, if no Multi db is found by that name.

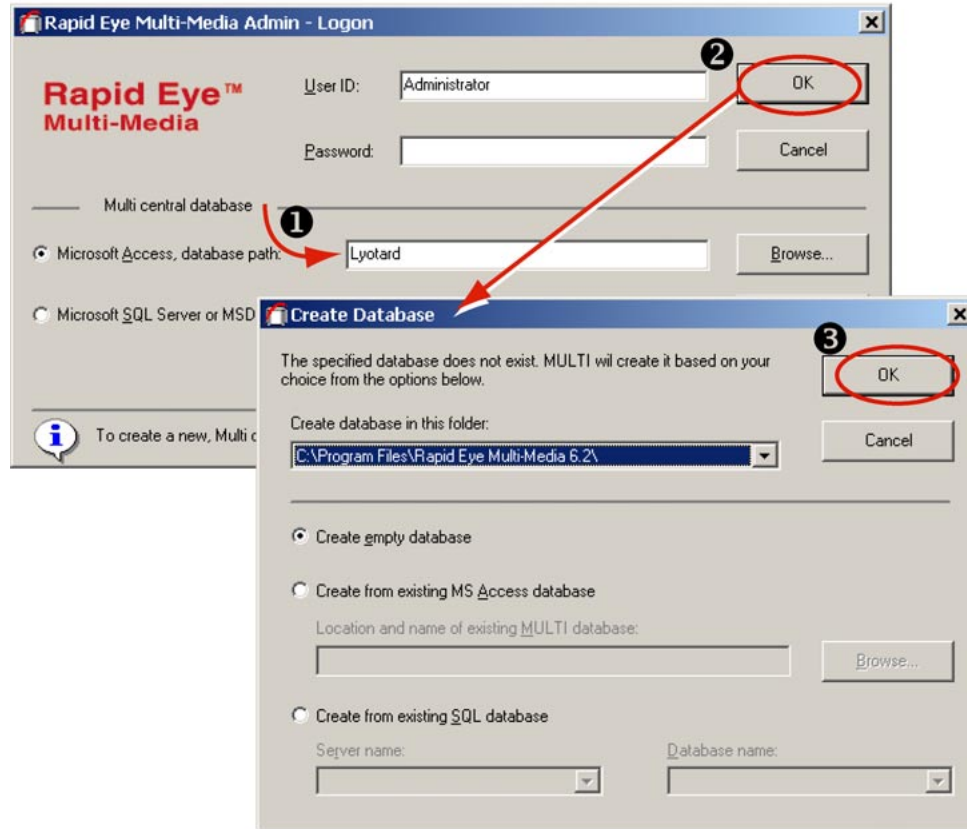

Fig. 24. You can add Rapid Eye site information to an empty Multi db, using the Microsoft Access engine, to test connections to Rapid Eye sites.

3.2.2 Obtaining a Multi Db

Double-duty logon dialog

Besides logging on to *Admin*, you can use the “Admin Logon” dialog to create an empty Multi database. After creating a database, Admin logs you on automatically.

You do not need to create a db each time that you log on.

➤34 To create an empty Multi db

1. Double-click the Admin icon (fig. 23). The Logon dialog is displayed.
2. Select “Microsoft Access Central database”.
3. Type a name, or a name and a path for the empty multi db.
4. Click **OK**. Your logon is deferred, and a “Create database” dialog is displayed. See figure 24.

- In the *Create Database* dialog, “Create empty database” is selected by default. Click **OK**. You are logged on to an empty database, bearing the name that you typed at step 2, and the Admin window appears.

What next?

Add site information to the database, as explained in the next section, 3.2.3.

3.2.3 Adding Site Information

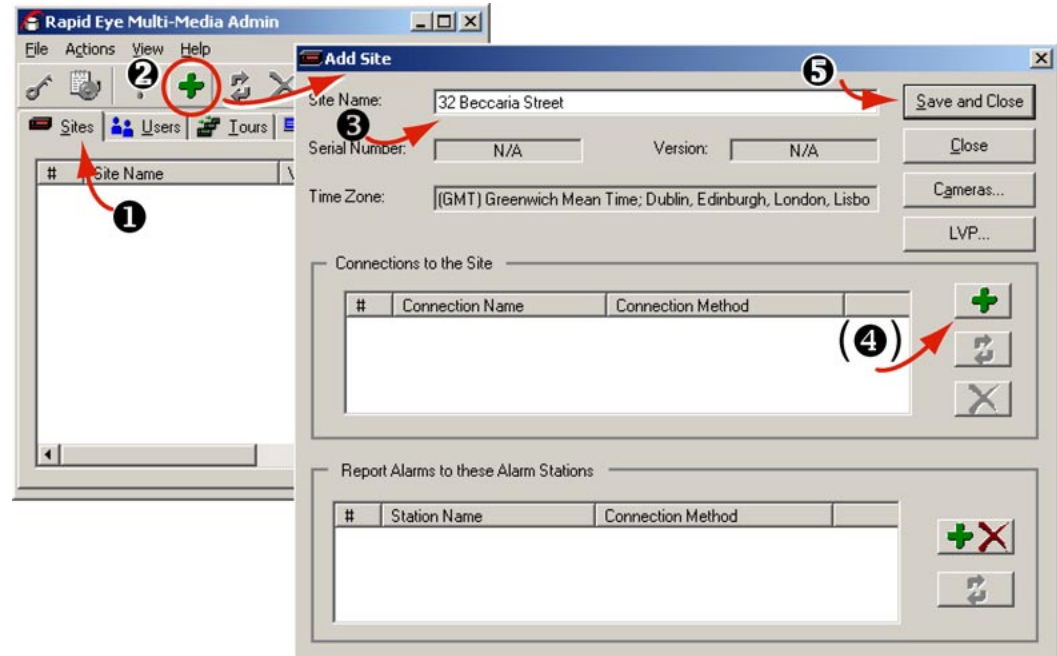



Fig. 25. Type the site name of your choice in the Add Site dialog.

Site identification checklist

- Name the site.
- Make a record of the type of connection used by the site.
- Click **Save and Close**.

➤ 35 To name a site

- Using Admin, click the *Sites* tab.
- To display the *Add Site* dialog box, either:
 - Click  on the toolbar (see figure 25).
 - or -
 - Click **Add** on the *Actions* menu.
- Type the name in the **Site Name** box. You have the option of clicking **Save and Close** or of setting up a connection.

Dealing with connections

Indicate which of the two basic connections you will use to test your Multi-Media unit:

- a dial-up connection
- a network connection

Confirmation

You network administrator can confirm that networked Multi-Media units can be reached by PING. For dial-up, verify that the telephone line and modem are working. See 2.9: *Field Testing a Connection*, on p. 2–16.

3.2.4 Record of a Dial-up Connection

➤36 To make a record of a dial-up connection

1. Click  in the “Connections to the Site” pane. The *Add Connection* dialog is displayed. The **Connection Name** box appends a stylized arrow and “Network” to the site’s name.
2. Click **Use Dial-up Networking**.
3. Admin automatically names the connection in the **Connection Name** box.



To access an outside line.

If your telephone exchange needs a prefix (an extra telephone key stroke such as a “9” or an “8”), set it in the Window's Telephony program used by the PC, not in Admin.

4. Leave the **Country Code** to “(dialing same country)”, unless the Multi-Media unit is in a different country than the View operator planning to use the site.
5. Type the unit’s **Area Code** and **Telephone Number**.



To access an outside line.

If your telephone exchange needs a prefix (an extra telephone key stroke such as a “9” or an “8”), set it in the Window's Telephony program used by the PC, not in Admin.

6. Click **Save and Close**. The Sites tab is displayed. In the tab’s Primary Connection column, the first letter of “dial-up” appears in parentheses: **(d)**, followed by the telephone number used to connect to the Multi video unit.

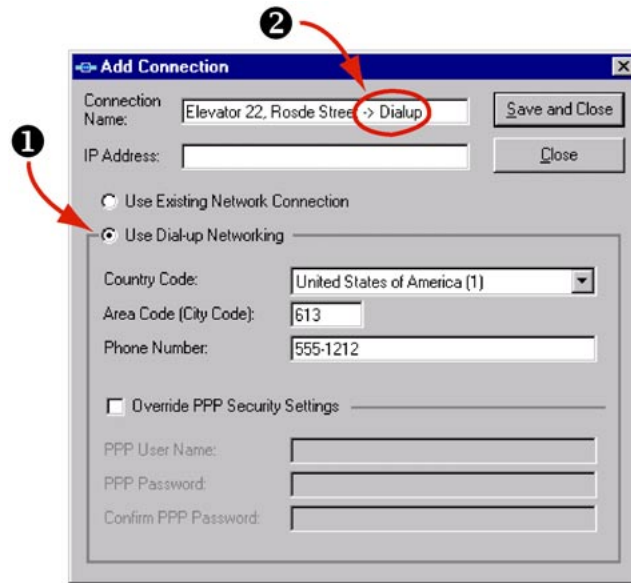

Fig. 26. The “-> Dialup” in the connection name appears as you click *Use Dial-up Networking*.

Dealing with dial-up confusion

Please see the *Admin User Guide*, if you need more sophisticated connection schemes, such as:

- **irregular use of area code #1.** long-distance call *within* one area code
- **irregular use of area code #2.** local call to *another* area code, as illustrated in figure 27
- **RAS.** calls involving a Remote Access Service (RAS) server
- **dial-up or network.** sites one can connect to using either.

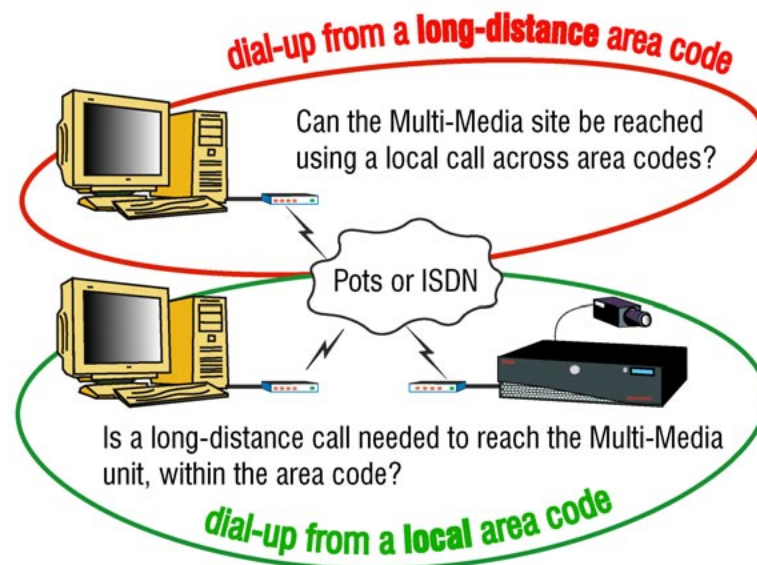



Fig. 27. Dial-up making irregular use of area codes occurs when a local call is used across area codes or when a long distance call is needed to dial-up in a local area code. This can fool Microsoft Windows' *Dial-Up Networking* application. You can set Multi to remedy this.

3.2.5 Record of a Network Connection

➤37 To make a record of a network connection

1. Using Admin software, in the *Add Site/Update Site* dialog, click  in the “Connections to the Site” pane. The *Add Connection* dialog is displayed. The **Connection Name** box appends a stylized arrow and “Network” to the site’s name.
2. In the **IP Address** box, type the Multi-Media unit’s IP address. The address is the same as the one given in the field to the Multi-Media unit; see 2.7: *Network Connection* on p. 2–9.

The IP Address is mandatory for a network connection.

3. You can choose to either:
 - Leave the *connection* name in the **Connection Name** box, as it was set automatically by Admin.
 - Type another name in the **Connection Name** box.
4. Click **Save and Close**. The Sites tab is displayed. In the tab’s Primary Connection column, the first letter of “network” appears in parentheses: **(n)**, followed by the IP address used to connect to the Multi video unit.

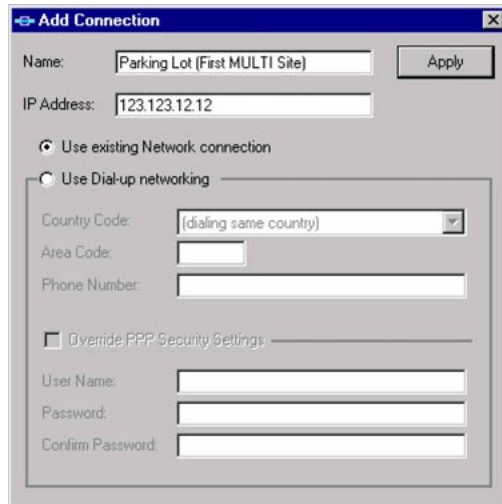

Fig. 28. Adding a pilot connection

3.3 Using View to Connect

Checking for video

View is used to display video from a Multi-Media unit. Before using a Rapid Eye site, a security validation is performed using a View *Maintenance session*. After this initial maintenance session, you use *View* to obtain video from the Rapid Eye site.



Fig. 29. View icon

Checklist for obtaining video

- log on to the Multi central database. This automatically makes a local copy of the Multi database to the PC, so that mobile PCs (laptops and so on) can use Rapid Eye sites.
- check the camera data and the connection as a whole by running a “Live” session. Obtaining video indicates a good connection. To troubleshoot, run a maintenance session to check video settings.

3.3.1 Firewall reference

Multi sessions (live, retrieval and alarm) are sent to port 10,000. For a list of port functions for Multi, see table 11.



Ports 10,000, 10,001 and 10,003 should be left open in your organization's firewall.

Table 11
TCP ports

Port	Name	Use	At ...
10,000	Base	live, retrieval and alarm sessions	Multi-Media unit operator station
10,001	Maintenance	maintenance session for configuration, security, and sending/receiving system files	Multi-Media unit operator station
10,003	Alarm	alarm server for callbacks	alarm station Multi-Media unit

3.3.2 Running View

Logging on to View

Three pieces of information are needed:

- **user account.** Use the “Administrator” account. It has the right to use all of the functions in View. It also grants access to every Rapid Eye site in your system.
- **password.** By default, there is no password for the Administrator account. You can add a password after testing is complete. Account and system passwords are explained and discussed in the *Admin User Guide*. If the password has been changed, see the organization’s Multi SA for an account.
- **database.** Use the same database used to log into Admin. See 3.2.1: *Running Admin*.

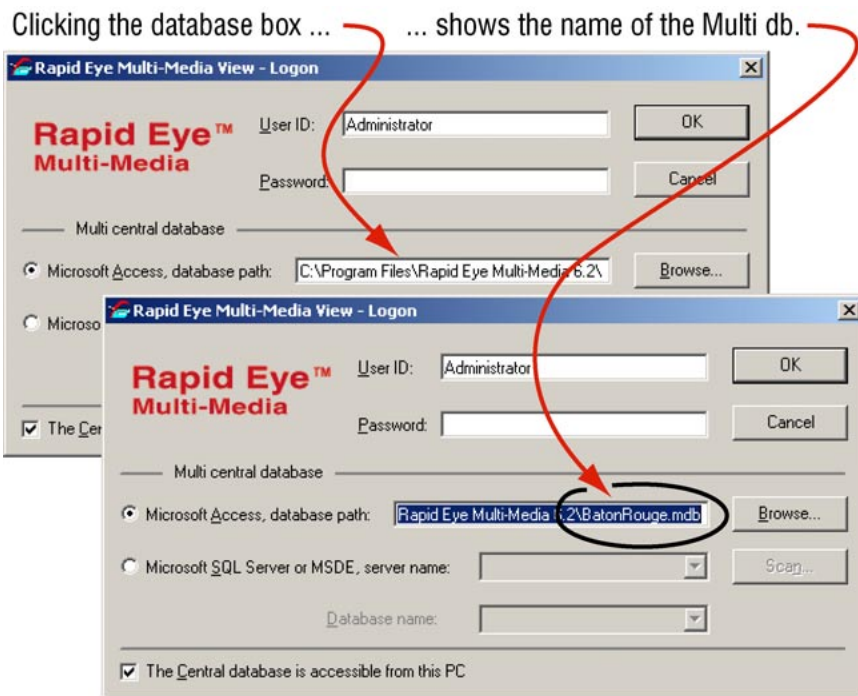

Fig. 30. Your database can have the name of your choice, as long as it is the same one used earlier, as in figure 24 on page 3–4.

3.3.3 Testing a Connection: Maintenance

Using Maintenance

Run a Maintenance session to set the Multi-Media unit’s time and configure the site’s cameras. A successful maintenance session also indicates that the record of the site in the Multi db is correct.

➤38 To run a maintenance session on a Rapid Eye site

1. Double-click the View icon (fig. 29). The “View Logon” dialog is displayed.
2. Log on using the “Administrator” **User Id** and the **Database** as for Admin (section 3.2.1). The Site tab in View should list the site(s) created in Admin.

3. To start a Maintenance session, either:
 - Right-click on the site name to select **Maintain** from the shortcut menu.
 - Select the site; then click the **Maintain** command on the Actions menu.

- or -

- Select the site; then click  on the toolbar.

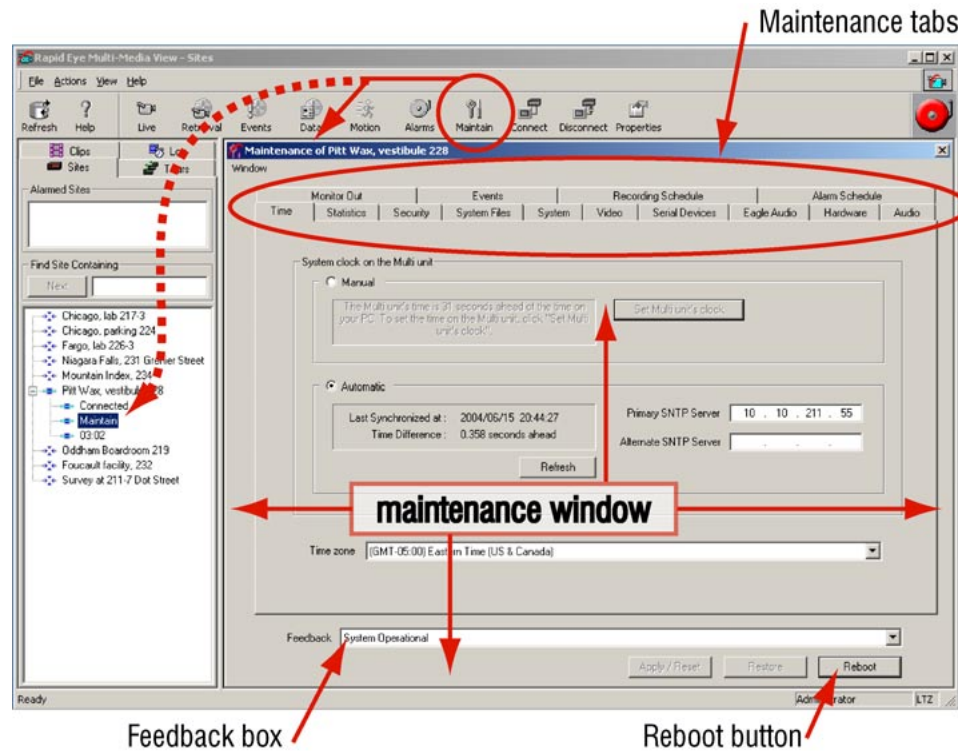

Fig. 31. A connection works when you see the “System operational” message in the **Feedback** box. It should appear after selecting a site and clicking **Maintain**.

3.3.4 Testing a Connection: Time

Crucial settings for reporting on video of events

Setting the **Time Zone** and **System Clock** on Multi-Media units is crucial to the correct identification of video. These settings also govern the scheduled recording and scheduled alarm features. Please set them with care.

Time zone

The installer or your Multi SA needs to indicate in which **time zone** each Multi-Media unit is installed. This setting needs to be made, whether a Multi-Media unit’s clock is set manually or automatically.



Setting the Time Zone of a unit is crucial for correctly reporting the video of events.

➤ **39 To indicate the time zone of a Multi-Media unit**

1. Using View, select a unit whose time zone needs to be set.
2. Start a maintenance session.
3. Click the Time tab. See figure 32.
4. If the zone indicated in the Time Zone box is incorrect, click the arrow in the box. A list of all time zones appears.
5. Scroll the list as needed to find a match for the time zone in which the unit is installed. The time zone is set right away; there is no need to reboot the unit.

The time zone is set on a unit-by-unit basis.
Repeat this procedure for all of the units in your system.

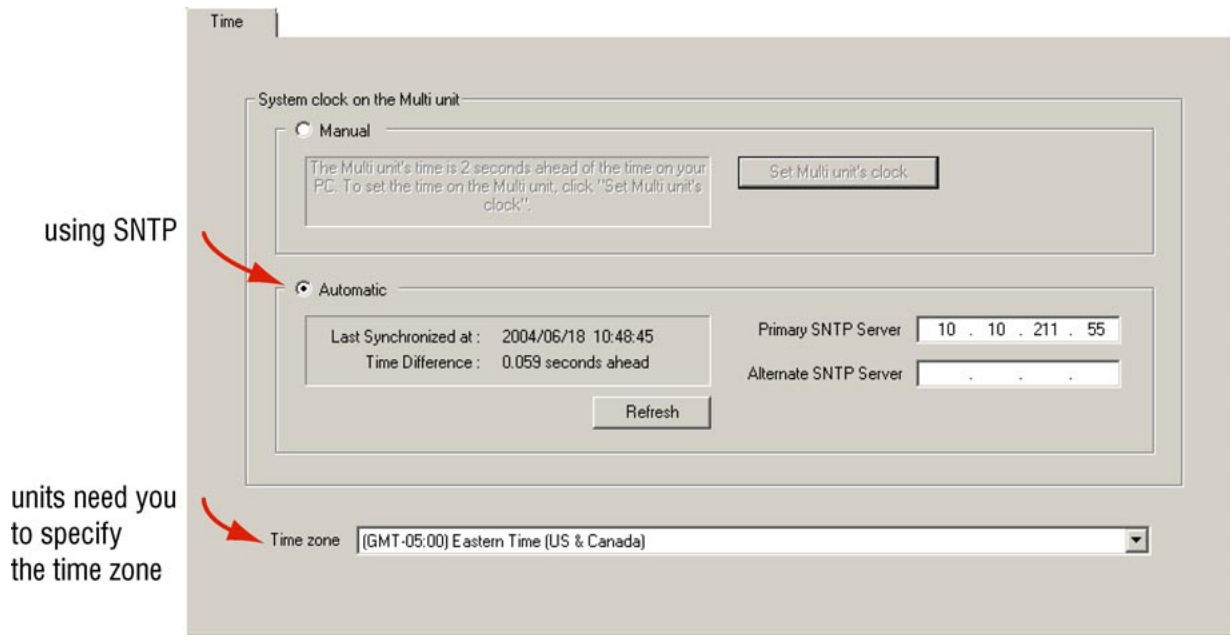

Fig. 32. Indicating the correct **Time Zone** in which a Multi-Media unit has been installed is crucial to avoiding confusion during the operation of your video surveillance system.

Conflicting time zones

A Multi-Media unit's time zone can be changed without the knowledge of a View operator. It can be done at the unit, using *LocaView*, or through another Multi-Media database (Multi db). The View operator's next attempt to access the site is interrupted by a message, shown in figure 33.

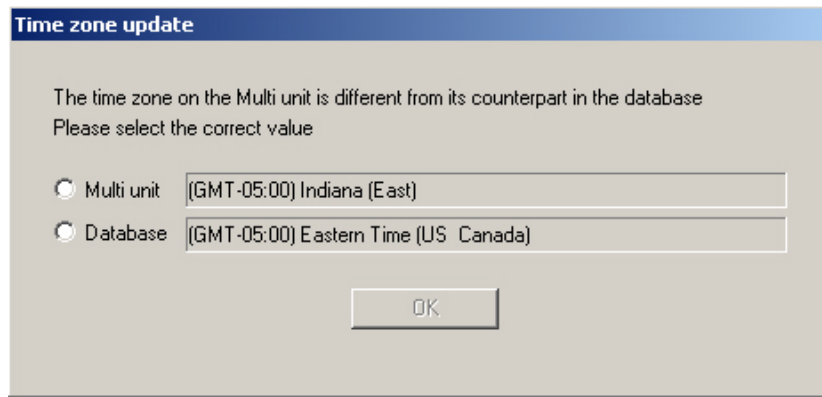

Fig. 33. Different rules for daylight savings time in one time zone.

The message also appears if a time zone's *area* is changed, since some areas within a time zone can have different rules for daylight savings time. For example: "Indiana (East)" in the Eastern time zone (GMT-5:00) differs from "Eastern Time (US Canada)", also in the GMT-5:00.

➤40 To respond to a notification of conflicting time zones

- Select the time zone that indicates where the Multi-Media unit is installed and then click **OK**.

Clock: Automatic setting

See your IT Administrator to find out if using a Simple Network Time Protocol (SNTP) server agrees with your organization's policies and procedures. Multi-Media units on a LAN can benefit from an automatic setting that is accurate to within a fraction of a second.

There are two SNTP boxes: **Primary SNTP Server** and **Alternate SNTP Server**. They hold IP addresses of SNTP servers. Your Multi SA can obtain these values from your network administrator.

➤41 To set a unit's clock automatically, using SNTP

1. Obtain the IP address of an SNTP server. You have the option of also obtaining the address of an alternate server.
2. Using View, select a unit whose clock needs to be set.
3. Start a maintenance session.
4. Click the Time tab.
5. If **Automatic** is not selected, click it. The Time tab appears as in figure 32.
6. Click the **Primary SNTP Server** box and type the IP address of an SNTP server obtained in step 1. You have the option of indicating an alternate in the **Alternate SNTP Server** box.
7. Click **Refresh**. The Multi-Media unit contacts the SNTP server and synchronizes the Multi clock to the SNTP time.
8. You have the option of ending the maintenance session.

Auto-synch statistics

Last Synchronized at. Latest time that the SNTP server was used.

Period. Time amount between synchronizations. A dynamic value, that keeps the unit's clock 0.4 to 0.2 seconds of the server's.

Time Difference. Accuracy of synchronization.

Auto-synch statistics do not apply to a clock set to Manual.

Clock: Manual setting

A Multi SA can synchronize the clock of a Rapid Eye Multi-Media unit using a PC's clock as reference. This is more useful for units connected only by dial-up, but can also be used for units on a LAN.

➤42 To set a unit's clock manually, using a PC's

1. Check the accuracy of the time and the time zone *on the PC* and adjust it as needed. To adjust a PC's time, date and time zone, click **Start** followed by **Settings, Control Panel** and **Date/Time**.
2. Using *View* software, select a Multi or Multi-Media unit whose clock needs to be set.
3. Start a maintenance session.
4. Click the *Time* tab. If **Manual** is not selected, click it. The Time tab appears as in figure 34.
5. Click **Set Multi-Media unit's Clock**. Please wait until the "Synchronized Time" message appears.

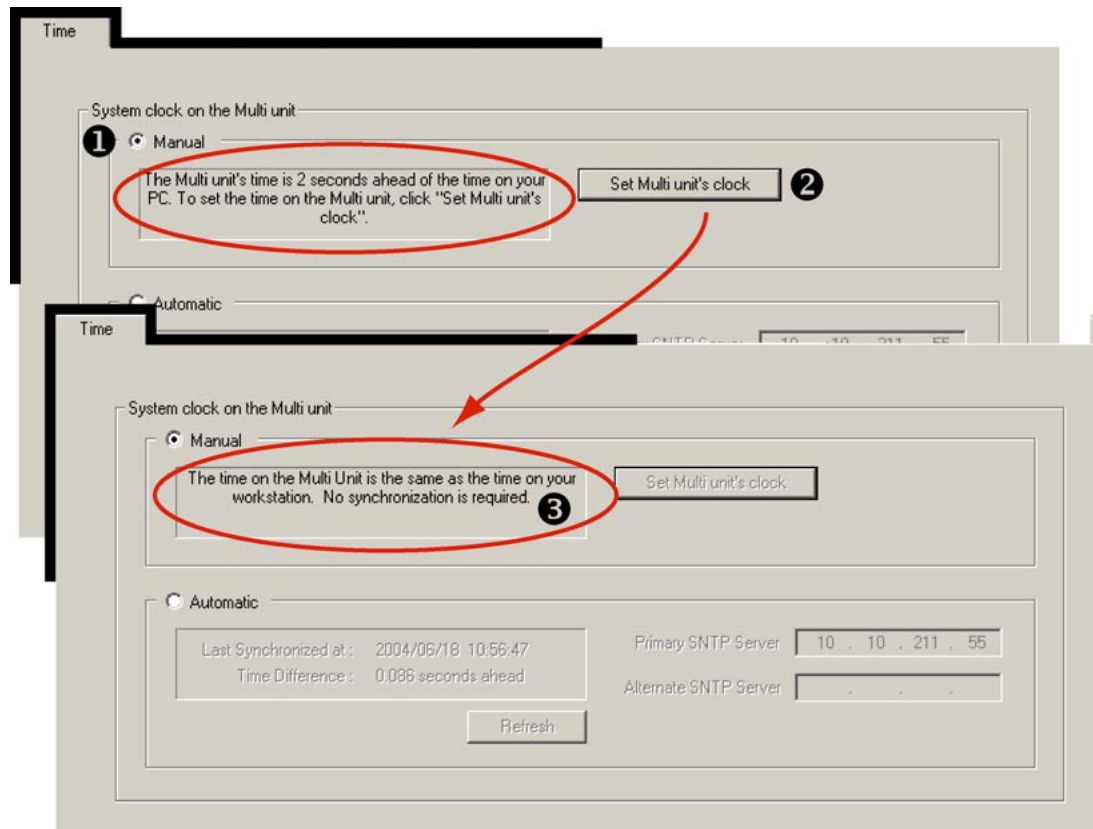
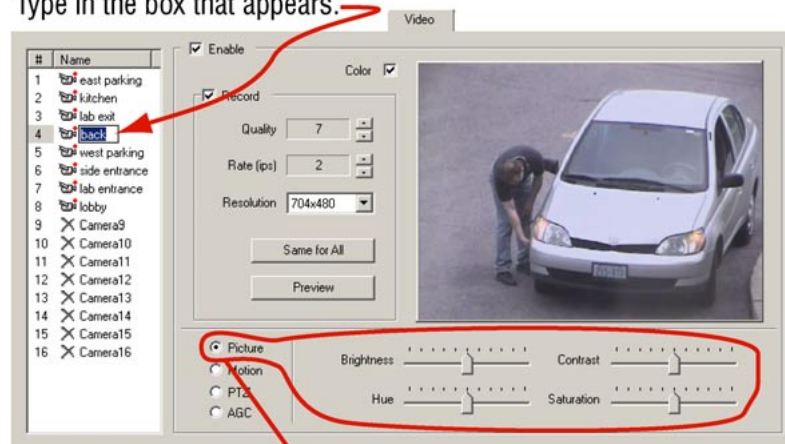

Fig. 34. Time tab indicating that a Multi-Media unit's clock could be synchronized to your PC's clock.

3.3.5 Testing a Connection: Camera

The cameras connected to a Multi-Media unit are detected automatically. You can name a camera and adjust a camera's picture settings during a maintenance session.

Rename a camera by clicking its name, then clicking again.
Type in the box that appears.



camera's picture panel

Fig. 35. Video tab in Maintenance session: video feed adjustments.

➤ **43 To configure a Rapid Eye site's camera(s)**

1. Run a maintenance session at the pilot site.
2. Click the **Video** tab and adjust Picture controls as needed. See figure 35. The adjustments are made on the fly; you do not need to click the **Apply/Reset** button, as for older Multi-Media units.
3. You have the option of ending the Maintenance session for the Multi-Media unit.

3.3.6 Obtaining Video

➤ **44 To obtain video from a “live video session”**

1. Start by obtaining the list of cameras at the site. Either:
 - Right-click on the site name to select **Live** from the shortcut menu.
 - Select the site; then click **Live** on the Actions menu.
 - Selecting the site; then click  on the toolbar.
2. Select cameras as required. Click **OK**. Video should appear. See figure 36.
3. End the Live session by closing the Live window or View.

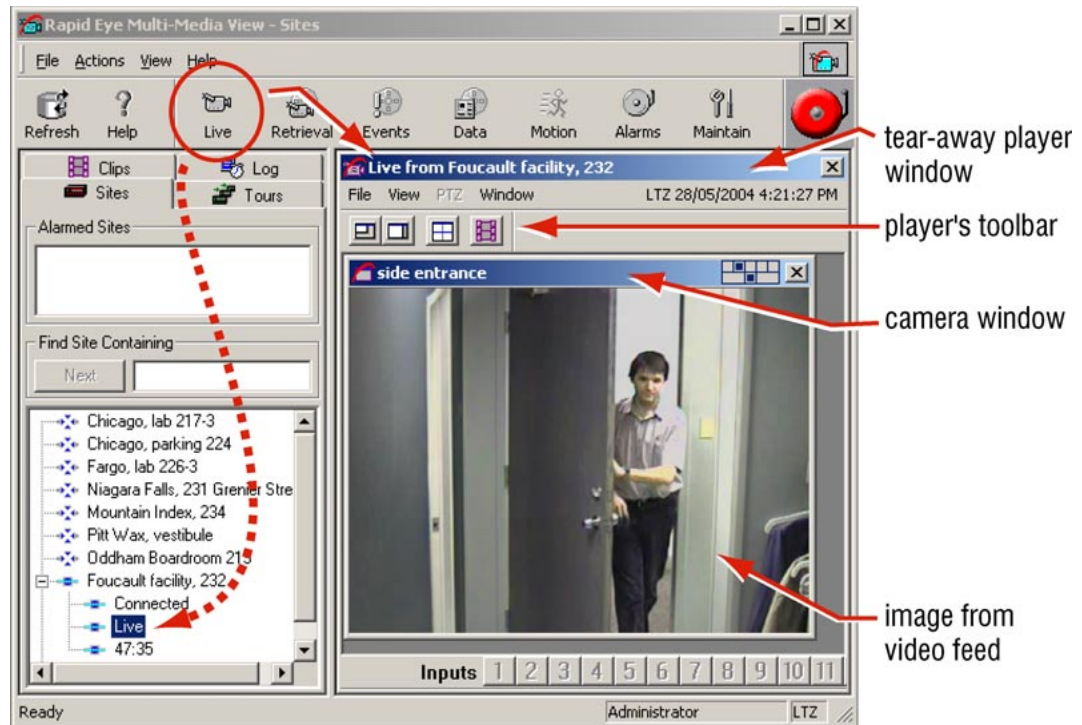

Fig. 36. Live video from a camera, renamed to “side entrance”, at a site called: “Foucault facility, 232”.

3.4 Results

To recap, the connection to the site has been checked and you have:

- used Admin to create a record for each unit in a Multi database
- used View to run a maintenance session to adjust the Multi-Media unit's time and camera(s)
- used View to run a live video session at the site.
- checked that the video feeds are effective: camera's distance from subject, angle and lighting.

3.4.1 What Next

After having established that video can be obtained *effectively* from a site, return to Admin to:

- change the security settings of your Rapid Eye Multi system
- add sites to the Multi central database and use View to test that the components at the site are set and working (time, video feed, outputs, audio feed, data recording, and so on)
- add user accounts to the Multi Central database.

Please continue.

4 Audio

4.1 Audio at a Multi-Media Site

Microphones

If security procedures call for viewing the person that is speaking, plan to place microphones in camera range. However, microphones can be placed independently of cameras; they have their own cabling. Microphones require amplification to provide line-level input to a Multi-Media unit; see figure 37.

channel 1 / LEFT
microphone

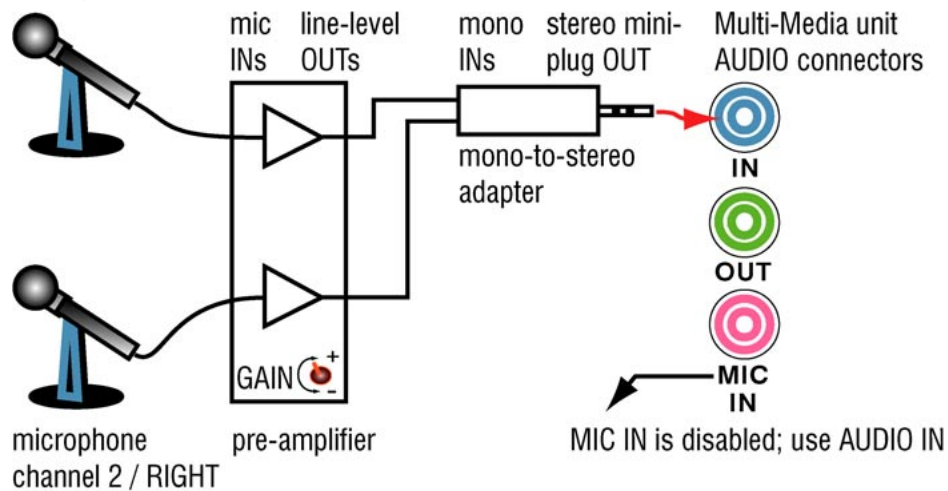

Fig. 37. Audio input to Multi-Media unit.

Selecting a microphone

Choosing a microphone type (condenser, canon, Lavalier, and so on), pickup pattern (cardioid, omni-directional, and so on), sensitivity, whether one needs phantom power, and other considerations, are beyond the scope of these installation instructions. Unlike camera domes, you can mix different models of microphone at a site. Please see your microphone supplier.

Placing a microphone

Microphone placement requires experience with noise sources, sound absorption and reflections; these topics are beyond the scope of these instructions. Please see your microphone supplier. See also 4.1.1: *Checking for Audio Interference*, next.

Speakers

Connect powered speakers to a Multi-Media unit so that people at the site can hear an operator. See figure 38.



Honeywell recommends that speakers be placed away from microphones, to avoid audio feedback.

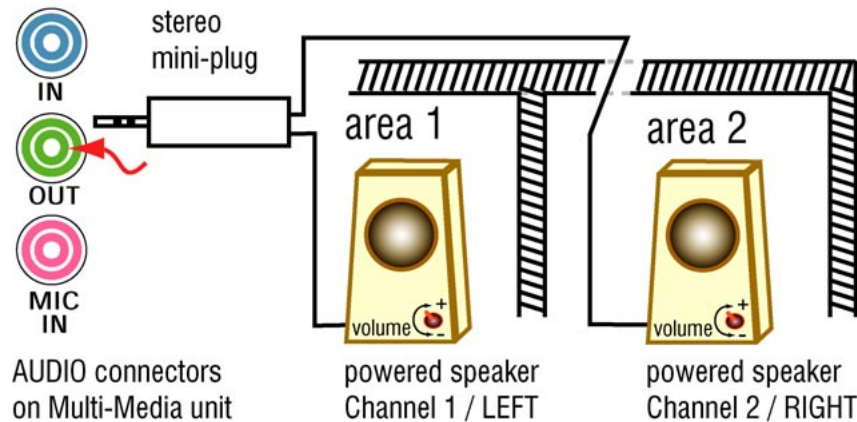

Fig. 38. Speaking remotely from a PC running View, or onsite using LocalView, an operator can communicate with people at the site.

Use the “[Audio] In” connector. The “Mic In” connector is disabled.

4.1.1

Checking for Audio Interference

Preventive measures

Checking one’s installation for hard-to-predict situations includes spot-checking for:

- **live audio.** Coordinate the testing of audio with fire alarm and security alarm testing. Using View, connect to that Multi-Media unit and check audio for feedback and interference, before and during alarms.
- **recorded audio.** After a day or two, check for background noise in recordings, using a retrieval session to spot-check each microphone for a few seconds at every half-hour or so, during a 24 hour period. This can reveal if microphones are placed too near sources of background noise such as a vent. Noise is amplified to a point where it interferes with audio. Hard to predict noise from the area’s soundscape—rush-hour traffic, passing trains and planes, crowds in a stadium, and so on—may not have been present during the installation of microphones and speakers.



Loud alarms should be tested during the installation; they can interfere with Multi-Media audio. If microphones and speakers are used while alarm bells are ringing, Honeywell recommends that Multi-Media audio equipment be sonically insulated from the loudness of the alarms.

Placing a microphone or speaker close to a ringing alarm bell can render either ineffective: the bell noise can mask the voice of an operator attempting to use the microphone. The bell could also mask a voice coming from a speaker. Loud alarms can interfere with microphones or a speaker when they could be needed most.

4.2 Audio for Operators

At View Operator's PC

When listening, sound sources are mixed at a View operator's station, regardless of the number of sites being monitored at once. Each Rapid Eye site can send two channels of audio to a View operator.

➤45 To send and receive audio offsite

1. Install a sound card on the View operator's PC.
2. Connect a microphone to *the PC's sound card*.
3. Connect a powered speaker to the PC's sound card.

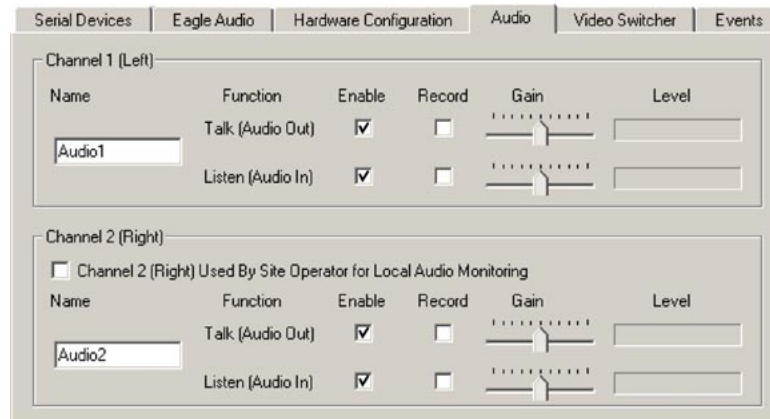

Fig. 39. Audio tab, set to deliver sound to and from the View operator's PC to two channels of audio, at one Multi site.



The Audio tab is unavailable on PCs without a soundcard.

➤46 To monitor and record

You can monitor, record or do both, for each channel.

1. Click the **Enable** boxes to enable transmission of sound from point to point and monitor it.
2. Click the **Record** box to record sound along with the video from the site.

➤47 To enable "talking to" a site

- Click the monitor **Talk** boxes, as needed for each channel; see fig. 39. An operator can broadcast on either or both channels, and to *as many sites at once* as can be opened, that have audio.



Loud alarms can interfere with microphones or a speaker at times when they could be needed most.

Onsite Audio, Using LocalView

Local View can be used to test or permanently monitor audio onsite.

➤ **48 To enable audio for use onsite, by LocalView**

1. Using LocalView, on the **Audio Setup** tab, add a checkmark to the box for **Channel 2 (Right) Used by Site Operator for Local Audio Monitoring**. The "channel 2" **Enable**, **Record** and name are not needed for monitoring audio by a LocalView operator and are removed from view. The **Gain** controls remain available for both audio channels.
2. In the Channel 1 controls, add checkmarks to the **Enable** boxes for **Talk**, **Listen** or both, as needed.
3. You have the option of adding checkmarks to **Record** boxes for **Talk**, **Listen** or both, as needed. The **Enabled** box needs to be checked before its **Record** box can be.

➤ **49 To disable audio for LocalView**

- On the **Audio Setup** tab, remove the checkmark in the box for **Channel 2 (Right) Used by ...**

5 Other Site Hardware

Audience

You can add hardware to a Multi-Media unit at any time. Multi software is then used to make Multi-Media units “aware” of the hardware. The steps to do so are outlined in the *road map*, below.

Before adding more hardware, Honeywell recommends that you test the connection to your unit, as explained in section 1.

Road map for adding hardware

After testing the connection from an operator’s PC to Multi-Media unit, you can:

- Place the Multi-Media unit and its camera(s) in their operational locations.
- Use View software to run a Maintenance session at the site to specify other (optional) hardware connected to the Multi-Media unit: extra cameras, gates controlled by a Multi operator, heat sensors.

Aside from cameras and communications, a Multi-Media unit can interface with many different types of hardware, such as:

- sensors: motion, heat, alarm and so on.
- relay triggered devices: locks, gates, warning sirens, and so on.
- alarm panel: a fault relay offers a means to monitor the unit’s operational status, using an external device.
- point of sale (POS) hardware, using text messaging over serial communications, or other device.

5.1 Securing a Multi-Media unit

When planning where to place a unit, Honeywell suggests that your planning authority be made aware of, and consider:

- allowing for access to the unit, if maintenance is required, yet preventing easy criminal tampering with the system
- and -
- environmental factors that can hamper a unit: lack of ventilation, dust, condensation, excessive heat or cold.

➤50 To secure the unit

1. Select a secure, clean, well-ventilated area for the Rapid Eye Multi-Media unit.
2. You have the option of rack-mounting the unit. Leave a one-inch space on the sides of the rack for ventilation.
3. Plug the supplied power cord from the rear of the Multi-Media unit to a grounded power supply.



Do not block the air intakes on the side of a Multi-Media unit.

A warning sticker indicates this on the right-hand side of the unit.



Placing equipment, such as a monitor, directly on top of the Multi-Media unit is not recommended.

5.1.1

Detachable Camera I/O

A detachable sub-panel is used for mounting the camera input/output (I/O) connectors and monitor outputs. This is convenient for swapping a unit with another without having to disconnect cameras from a unit.

➤51 To detach the sub-panel

1. Power down the unit.
2. At the back of the panel, unscrew the two thumbscrews. See fig. 40.
3. Pull the panel straight out, to avoid bending pins of the connectors inside.

Detaching the panel can serve to speed-up servicing or replacement of a Multi-Media unit, while preserving camera wiring.

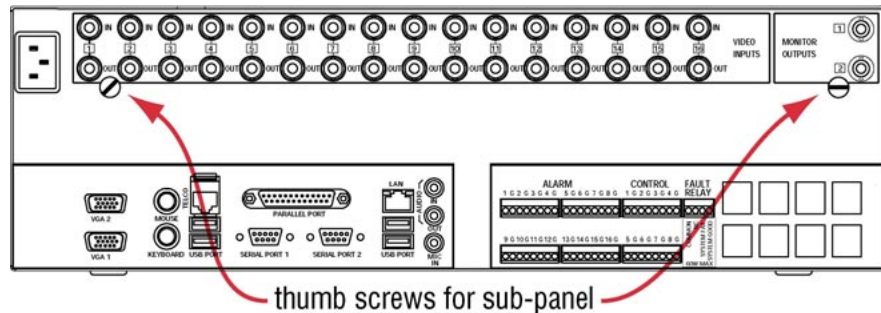

Fig. 40. Removing the camera input/output (I/O) connectors.

5.2

Unit Hard Disk

S.M.A.R.T. checking for degradation

Hard disk use on a unit for storing video, audio and data, is monitored for signs of degradation that can lead to failure. Degradation is reported on a Multi-Media unit's blue LCD screen as: "CRITICAL STATE: DISK FAILURE". The pilot light on a disk drive turns red to identify a hard disk that is degrading. This degradation report is also a Multi-Media event: S.M.A.R.T. (Self Monitoring Analysis and Recording Technology).

5.2.1

Hard Disk Report

The SMART report is not a cause for alarm. It is a suggestion that the hard disk should be replaced. Contact an authorized Honeywell dealer to obtain a mounted hard disk for your Multi-Media unit. See figures 41 and 42.

1. Loosen screws, then ...

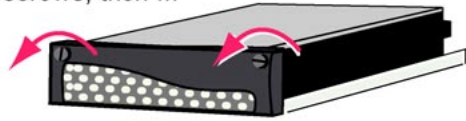

2. ... swing open the handle.



Fig. 41. Handle on mounted hard disk.



Fig. 42. Pull to remove a mounted hard disk from a unit; push to insert. Remove the front cover of the unit beforehand.

5.3 Hardware Options

A Rapid Eye Multi-Media unit interfaces with hardware such as:

- cameras, domes that pan-tilt-zoom (PTZ)—5.4: *Connecting a PTZ Dome*;
- alarm sensors, connected to a Multi-Media unit's inputs—5.6: *Inputs for Sensors*;
- relay triggered devices, including locks, gates, warning sirens, and so on, that connect to the outputs of a Multi-Media unit—5.7: *Control Outputs*;
- relay triggered device for system monitoring—5.8;
- point of sale hardware, with text messaging over serial communications, or any other device with serial communication capability—5.9;
- and -
- secondary communications (network or dial-up), including an external modem—5.10.

5.4 Connecting a PTZ Dome

To connect the **Data In** port of a PTZ dome (an RS-485 connector) to one of the ports on a Multi-Media unit (RS-232 connector), a 232/485 converter is needed. Configure a PTZ camera using Maintenance functions in Multi View software.

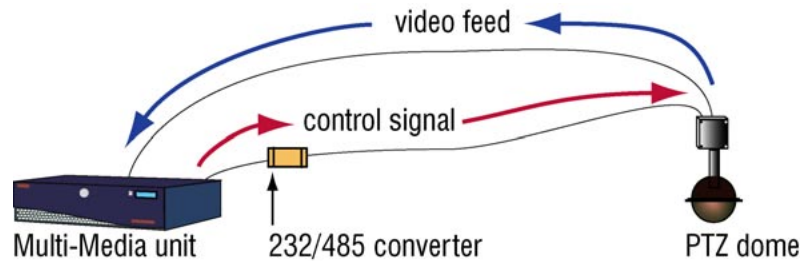

Fig. 43. PTZ wiring plan

Multi supports pan, tilt, and zoom (PTZ) domes listed in table 13. A site supports only one type of PTZ software driver at a time. This usually means that only one type of PTZ hardware can be used at a site.

Communicate the address used by the PTZ to the Multi SA, after the installation.

5.4.1 Converter: Technical Notes

A 232/485 converter interfaces a PTZ dome/controller to the Multi-Media unit. The converter amplifies PTZ control data for transmission over longer distances for a maximum of 1.2 km (or 4,000 feet).

Cabling

For the cabling to connect a PTZ dome to a converter and from the converter to the Multi-Media unit, see the converter's documentation.

Table 12
Cabling a PTZ dome

Type	Dome to converter	Converter to Multi-Media unit
Javelin / Pelco	RS-485 cable	25-pin male to 9-pin female to RS-232 port - not included
Kalatel	RS-485 cable	9-pin female to RS-232 port - included with KTD-312 computer interface

5.4.2 Daisy-chaining Domes

Connecting more domes

You can connect up to 16 domes on one communication line connected to the Multi-Media unit. Terminate the *communication* input(s) of the last dome in the chain. Leave other domes un-terminated.



Honeywell recommends that cable not be “T-tapped”; this can introduce unwanted distortion into the video signal.

To obtain a video feed, use an output port on the Multi video unit.

5.4.3 Configuring PTZ

You can use other PTZ hardware and its software driver at another site. For software driver and baud rate, see table 13.

Configure each PTZ unit to communicate at its default baud rate. See the *Rapid Eye Multi-Media Admin User Guide* for procedures to enable a PTZ dome.

Table 13
PTZ drivers for controllers and domes

Driver name (alphabetical)	Baud rate	Supported controller/dome
Javelin 308	9600	Javelin 308 Controller and others
Kalatel	9600 or 2400	Kalatel KTD 312 Cyberdome
Pelco D	4800*, 9600, or 2400	Pelco D: many domes
Pelco P	2400	Pelco P: many domes
Rapid Dome/Orbiter [†]	9600	RapidDome or Orbiter
Sensormatic RS422 [§]	4800	SensorMatic RS422: Delta and Speed
Ultrak (using VCL)	2400	Ultrak (configured as VCL)

* A value of “4800” is typical; other values can be used as needed.

[†] In other versions, this driver is jav306 or Javelin/ADEMCO.

[§] This driver’s name was “Delta” in older versions of View.

After selecting a driver for PTZ, adjust the domes post-use behavior by using View software and running a Maintenance session. The settings are on the **Video** tab.

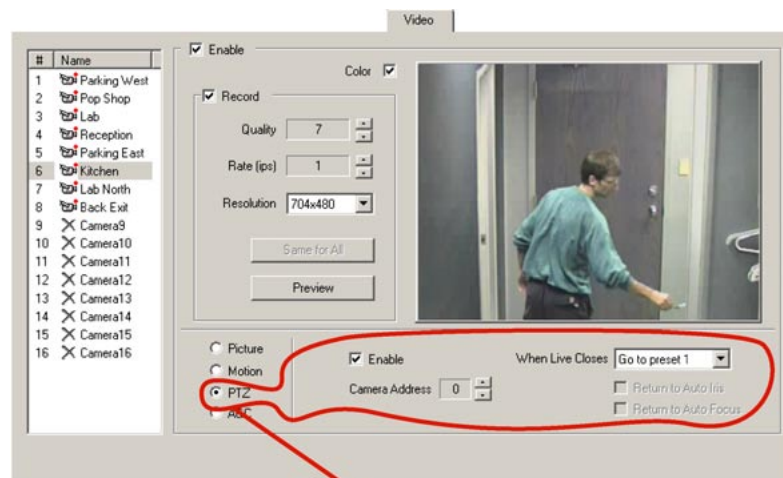

camera's pan-tilt-zoom panel

Fig. 44. Video tab: PTZ settings.

5.5 Alarm Sensors

Tools

You need:

- a slot screwdriver—supplied. The screws are slightly smaller than those for a 1/8" screwdriver.
- and -
- a wire stripper.

Cable

To connect alarm-type hardware to a Multi-Media unit, use hookup wire in the 20-gauge range.

➤52 To connect an alarm sensor

1. From the alarm wires' tips, strip approximately 0.6 cm (1/4 inch) of insulation.
2. Insert each alarm wire into the screw-type, terminal connector on the ALARM terminal strip: one wire to the numbered terminal connection and the other wire to ground.



To avoid short-circuits, ensure that bare wire is not visible at the rear panel.

5.6 Inputs for Sensors

➤53 To configure inputs

1. Using *View*, start a maintenance session for the Rapid Eye site. Please wait until the "System Operational" message is displayed.
2. Click the **Events** tab. More tabs are displayed.
3. Click the **Inputs** tab.
4. Next to an input reported as "in use" by an installer, type the name of the input in the **Input** box. You can type a name of your choice.
5. Click the **NO**, **NC** or **EOL** button, as needed.
6. Ignore the "Log" and "Alarm" checkboxes.
7. Click **Apply/Reset**.

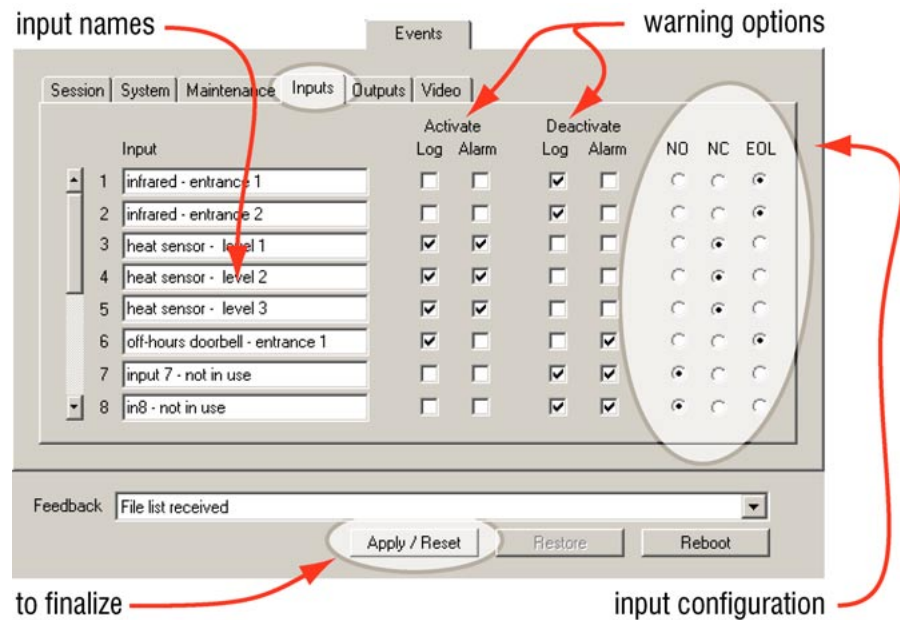

Fig. 45. Input configuration during a maintenance session. By default, alarm/control inputs are configured as NO.

Inputs to a Multi-Media unit, used by hardware devices

Installers should report if input devices are using connections that are: normally open, normally closed or end-of-line.

5.6.1 Input: Technical Notes

NO: normally open

The sensor inputs to a Multi video unit are configured for normally open (NO devices; see figure 46).

NC: normally closed

Most alarm sensor units have a dry contact for outputs, usually providing NO contacts or NC contacts (see figure 46).

EOL: end of line

A sensor input can also be configured as EOL (end-of-line or protected).

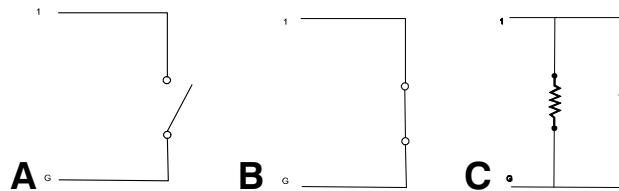

Fig. 46. Schematics: (a) normally open, (b) normally closed or (c) end-of-line

Table 14
Sensor hardware

Acronym	Sensor Input	Implication
NO	Normally Open	input is active when switch goes ON
NC	Normally Closed	input is active when switch goes OFF
EOL	End of Line	input is active when switch goes ON, or if wires to the alarm sensor are cut

5.7 Control Outputs

Purpose

A View operator can activate outputs.

Up to 24 mA can be drawn at each output.

Cable

Use hookup wire in the 20-gauge range to connect the outputs to relay triggered devices (locks, gates, warning sirens and so on) to a Multi-Media unit.

Tools

You may need:

- a slot screwdriver—supplied. The screws are slightly smaller than those for a 1/8" screwdriver.
- a wire stripper.

Connector

1. From the hookup wires' tips, strip approximately 0.6 cm (1/4 inch) of insulation.
2. Insert each relay control wire to the screw-type, terminal connector on the CONTROL OUTPUTS terminal strip: one wire to ground and the other wire to the numbered connection you choose.



To avoid short-circuits, ensure that bare wire is not visible at the rear panel.

5.8 System Monitoring

Fault relay

A Multi-Media unit can be monitored for failure:

- to function
- to report alarms

Should such a failure last more than 19 minutes, the FAULT RELAY is triggered.

Alarm panel

An alarm panel or other external device can be preset to warn your organization, if failure occurs. Failure to operate due to a power failure also triggers the relay, but does so immediately.

Software setup

➤ 54 To set the FAULT RELAY to trigger

1. Using *View* software, start a maintenance session.
2. On the System tab, enable either:
 - Enable Status Pulse...
 - Monitor Alarm Reporting
 - **both**. See figure 47.
3. Click **Apply/Reset**.
4. On the Events tab, click the **Outputs** subtab.
5. The name of Output 6 has changed to “System Status Pulse”. You have the option of changing the name of the output by typing in the box.
6. You have the option of ending the maintenance session.

To monitor the unit using an external device

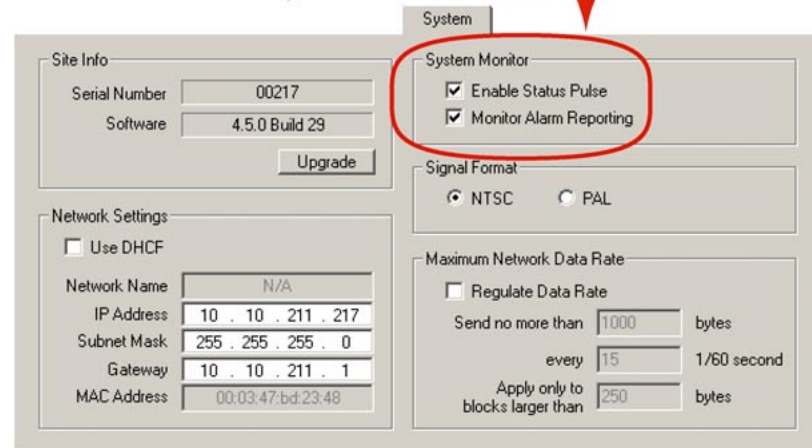

Fig. 47. Settings for monitoring a unit.

Enable Status Pulse. Enables the FAULT RELAY to trigger.

Monitor Alarm Reporting. Interruptions in reporting of alarms, greater than 19 minutes, trigger the fault relay. The monitoring is designed to report alarms that have not reached their designated alarm station, because of that alarm station being unavailable.

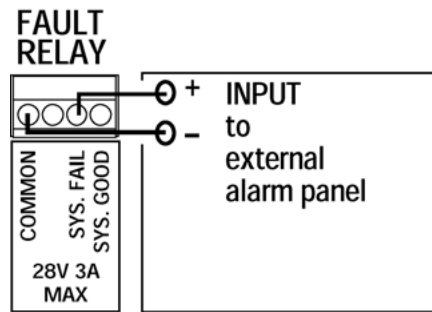

Fig. 48. FAULT RELAY connector on Multi-Media unit's back-panel, showing connection to an external alarm panel.



Do not connect a device to CONTROL output 6 after enabling the FAULT RELAY. Enabling the FAULT RELAY provides a status pulse at **CONTROL 6**, disabling it as a general-purpose output. Connecting a device to **CONTROL 6** could interfere with the relay's performance.

5.9 Point of Sale Hardware

Cable

For a point-of-sale (POS) device or other data communication equipment (DCE), use a standard RS-232 cable with a female DB-9 connector.

5.9.1 Configuring POS

For procedures on using the Data Recording tab in the Maintenance dialog, to configure POS devices, consult the *Admin User Guide* for Rapid Eye Multi-Media units.

5.10 External Modems

At unit, connected to a network

You can connect an external modem to a LAN-based Multi-Media unit.

- **for POTS.** Honeywell recommends a U.S. Robotics Sportster, transmitting at a least 33.6Kps, for POTS connections.
- **for ISDN.** A U.S. Robotics Courier I-Modem is recommended for ISDN connections. Please refer to your modem manufacturer's documentation for the modem's configuration.

For use of an external modem with a POTS-based Multi-Media unit, contact Honeywell Video Systems technical support, at: 1 (800) 796-2288; i.e., 1 (800) 796-CCTV.

5.11 Port Use: Restrictions

Some serial port connections on a Multi-Media unit are not allowed; see table 15.

Table 15
Serial port use: restrictions

serial connection	connect only to serial port (COM) ...
data recording device	1
serial switch	1
null-modem cable for terminal session	2

USB port and Parallel port

The **USB** ports and Parallel port at the back of the REMM unit are for future use.

Do not connect devices to the USB ports or to the parallel port of a REMM unit.

Multiple serial switches

Nested serial switches are not supported in Multi software; please do not connect more than one to a Multi-Media unit.

Using null-modem cable for installation of Multi-Media unit

If a null-modem cable is needed to install a REMM unit, plug it into SERIAL PORT 2.

Please continue.

6 Frequent Questions

6.1 Supporting an Installation

If you are installing a Multi-Media unit and having trouble, see the frequently asked questions (FAQs) listed in table 16. Similar questions are used by Honeywell technical support, when customers call.

Table 16
Installation FAQ

#	Frequently asked question	Section
Cannot install or use Admin		
1	How do I find out which Microsoft patches need to be installed on my PC, needed to run Multi software? The installation program lists missing patches. Patches are provided by Microsoft's web site.	3.1
2	Has the password to the "Administrator" account been changed? Ask your Multi SA to check your user account, using Admin.	3.2.1
3	Does your user account have the right to log on to Admin? Ask your Multi SA to check your user account, using Admin.	3.2.1
4	How does one know what IP address to use for the site? Have the installers submitted a report of the installation? A Site Information Checklist can be found starting on p. 7-8.	2.3 & 7.5
5	Is the Multi database accessible from the PC? Your network administrator can help with rogue paths to a destination, mapped drives, a missing IP address, and so on.	2.3
Cannot connect to Multi-Media unit, using View		
6	Can you log on to View? If not, your user account may not be valid.	3.3
7	Is the site listed? If not, then information is missing in the database or you are using the wrong database at logon. Quit View and logon again, making sure that the correct database is in use. If it is, ask your Multi SA to check the Multi database.	3.2.2 & 3.3.3
8	The PC should be using the same logical type of connection as the unit's: network or dial-up.	2.7 & 2.8
9	For units on a LAN, was an IP address assigned to the unit in the field?	2.7

#	Frequently asked question	Section
No video is reaching View		
10	How are the cameras connected?	2.5
11	Is there a power outage? Has the UPS failed?	2.4
12	Are the unit, cameras and other hardware powered?	2.4.1
13	Does the site connection information, in the Multi database that you are using to log on, reflect the type of connection used by the PC and the Multi-Media unit: network or dial-up?	3.2.2

See also

7.4: *More FAQs*, p. 7–5.

6.2 Background

Planning

Closed circuit television (CCTV) can help assess an area, assist with police work when an area becomes a crime scene, and so on. Some forethought about unit tampering can help provide optimal gathering of evidence, for corporate use, or use of video in a court of law.

When planning where to place the unit and its video cameras, Honeywell suggests that your planning authority be made aware of, and consider:

- allowing for access to the unit, if maintenance is required, yet preventing easy criminal tampering with the system;
- working around camera blind spots due to: architecture, mobile equipment, vehicle docking, construction and so on;
- dealing with environmental lighting situations that can render a system ineffective: direct sunshine or other strong lighting, darkness and so on;
- dealing with environmental factors that can hamper a unit or its cameras: dust, condensation, excessive heat or cold, and so on;
- supplying adequate power to the unit; critical sites may benefit from an uninterruptible power supply (UPS);
- connecting the FAULT RELAY to an alarm panel, to monitor systems status;
- and -
- the type(s) of communications used to obtain information from the Multi-Media unit: dial-up, network, both, or dial-up to a network.

Reference

For these and other background questions about the field of closed-circuit television in a security setting, a standard, reliable, in-depth reference is:

- Kruegle, Herman, *CCTV Surveillance: Video practices and technology*, Butterworth–Heinemann, Newton (MA), 1995, ISBN 0-7506-9028-3, TK6680.K78

6.2.1 Coaxial Cable

Cabling to camera

For short camera-to-monitor distances (several hundred feet), use pre-assembled or field-connected lengths of RG59/U coaxial cable, with continuous shielding, using a BNC connector at each end.

Length limit

The cable length between a camera and the Multi-Media unit should be limited to 230 meters/750 feet. When installing coaxial cable, avoid loops, kinks, or wraparounds.

Table 17
Recommended maximum length of coaxial cable

Requirement	Length (feet)	Length (meters)
not amplified	750	230
amplified	3,400	1,035

Amplifier

As needed, optional video signal amplifiers can be used where longer distances separate cameras and monitors. Amplifiers at the camera output or along the coaxial cable run increase camera-to-monitor distance to a maximum length of 3,400 feet for RG59/U cable.

Coaxial cable checklist

- Terminate all unused inputs and unused outputs in their correct impedance.
- In long cable runs, use the minimum possible number of connectors. Each connector causes attenuation.
- In long transmission systems, use balanced coaxial cable.
- Splicing coaxial cables can cause reflection of the signal, resulting in distortion, when improper connectors are used.
- For outdoor applications, use weatherproof connectors.

6.2.2 Grounding

Consult a certified electrician to avoid ground loops—video and audio—in your Multi system. Unbalanced coaxial cable runs between low power sources can create ground loop problems.



Do not remove the third wire on a three-prong electrical plug (aka “lifting” the ground). This is a violation of local electrical codes, and goes against recommendations of the Underwriters Laboratory.

6.2.3 Electrical Interference

To manage electrical interference (also called electro-magnetic interference or EMI), you can survey the facility for electronics that generate EMI “noise”—fluorescent lights, radio frequency (RF) receivers or transmitters, power lines or elevator shafts—before installing equipment. Cables can be routed around or away from sources of noise so that there is no interference with the CCTV signal.

Hum bar

Hum bars appear as horizontal distortion across the monitor. The hum bar is caused by the effect of high voltage on the horizontal synchronization signal.

Triaxial cable

Use triaxial cable instead of coaxial cable when the cable must be routed through an area having EMI caused by:

- large machinery
 - high voltage power lines
 - refrigerator units
 - microwaves
- and so on -

Triaxial cable has a center conductor, insulator, and shield, followed by a second insulator and shield. The double shielding significantly reduces the amount of EMI radiation that is exposed to the center conductor.

6.2.4 Lighting

A big factor of image quality is the amount of light reaching a camera’s lens. You can manage lighting by moving the CCTV cameras in consideration of:

- beam angle from the light source to the camera lens
 - intensity of reflection and contrast from objects in a camera’s field
- and -
- complexity and motion at the scene.

7 Find-it

7.1 Knowledge Base

- 1 Connect cameras (as many as 16) to the Multi-Media unit 1-2
- 2 Connect the Multi-Media unit to a network or telephone line 1-2
- 3 Supplying power to the unit and the cameras 1-3
- 4 Locate a personal computer (PC) running Multi software 1-3
- 5 Start Admin to create a Multi database 1-4
- 6 Log on to a Multi database, or create one using *Admin* 1-4
- 7 Using *Admin*, add a site 1-4
- 8 Add information about the connection, and save it 1-5
- 9 To use View 1-5
- 10 Log on to *View* 1-6
- 11 Test the connection; use *View* to run a Maintenance session 1-6
- 12 Start a Live session 1-7
- 13 Road map to field work 2-1
- 14 To unpack a unit 2-1
- 15 The power up sequence recommended by Honeywell 2-5
- 16 The power down sequence 2-5
- 17 To enable the locking of a LocalView functions 2-8
- 18 To change a LocalView password 2-9
- 19 To assign an IP address to a unit using LocalView 2-10
- 20 To connect a null-modem cable 2-11
- 21 To setup a terminal program 2-11
- 22 To use the Multi-Media Shell 2-13
- 23 To assign an IP address to the Multi-Media unit 2-13
- 24 To quit the program 2-14
- 25 To return to the Multi-Media Shell after a time out 2-15
- 26 To connect the Multi-Media unit to a telephone line jack 2-15
- 27 To field-test a dial-up connection 2-16
- 28 To field-test a network connection 2-16
- 29 To deal with a damaged Multi-Media unit 2-16

➤30 To upgrade a Multi-Media unit's software, onsite	2-17
➤31 Road map for using Multi software to obtain video	3-1
➤32 To install Multi software	3-2
➤33 To continue installing a Multi-Media unit ...	3-3
➤34 To create an empty Multi db	3-4
➤35 To name a site	3-5
➤36 To make a record of a dial-up connection	3-6
➤37 To make a record of a network connection	3-8
➤38 To run a maintenance session on a Rapid Eye site	3-10
➤39 To indicate the time zone of a Multi-Media unit	3-12
➤40 To respond to a notification of conflicting time zones	3-13
➤41 To set a unit's clock automatically, using SNTP	3-13
➤42 To set a unit's clock manually, using a PC's	3-14
➤43 To configure a Rapid Eye site's camera(s)	3-16
➤44 To obtain video from a "live video session"	3-16
➤45 To send and receive audio offsite	4-3
➤46 To monitor and record	4-3
➤47 To enable "talking to" a site	4-3
➤48 To enable audio for use onsite, by LocalView	4-4
➤49 To disable audio for LocalView	4-4
➤50 To secure the unit	5-1
➤51 To detach the sub-panel	5-2
➤52 To connect an alarm sensor	5-6
➤53 To configure inputs	5-6
➤54 To set the FAULT RELAY to trigger	5-9

7.2 Tables

Table 1 contents of Rapid Eye's hardware kit, WAMULTI5HWP4	2-2
Table 2 contents of Rapid Eye's software kit, WAMULTI5SWP4	2-2
Table 3 Panel connectors	2-3
Table 4 Time needed for a Multi-Media unit recovery	2-6
Table 5 Restriction for LocalView cycle times when setting low recording rates	2-9
Table 6 Commands for launching <i>HyperTerminal</i>	2-13
Table 7 Settings for <i>HyperTerminal</i> communications session	2-13

Table 8 Default Multi network settings	2-14
Table 9 Multi-Media Shell commands	2-14
Table 10 Default modem settings	2-16
Table 11 TCP ports	3-9
Table 12 Cabling a PTZ dome	5-4
Table 13 PTZ drivers for controllers and domes	5-5
Table 14 Sensor hardware	5-8
Table 15 Serial port use: restrictions	5-11
Table 16 Installation FAQ	6-1
Table 17 Recommended maximum length of coaxial cable	6-3

7.3 Illustrations

Fig. 1. Use the first available "IN" on the Multi back-panel for a camera.	1-2
Fig. 2. Use standard connectors for network (LAN) or telephone line (TELCO).	1-2
Fig. 3. Consider also plugging in cameras into the uninterruptible power supply used for a unit.	1-3
Figure 4. To install <i>Admin</i> and <i>View</i> software, run the Multi Admin CD-ROM. If Microsoft patches are needed for your Windows system, consult the <i>Operator Software Setup Instructions</i> , part #K5401.	1-3
Fig. 5. Shortcut for <i>Admin</i> , on the Windows desktop	1-4
Fig. 6. The window for logging on can also be used to obtain an empty Multi central database.	1-4
Fig. 7. From the Admin "Sites" tab, you can add, name, update and delete a site.	1-4
Fig. 8. Select a network or dial-up connection.	1-5
Fig. 9. Shortcut for <i>View</i> , on the Windows desktop	1-5
Fig. 10. Use the same database created earlier, using Admin; see fig. 6 on p. 1-4.	1-6
Fig. 11. A connection works if you see "System operational" in the Feedback box.	1-6
Fig. 12. Select a site on the Sites tab, then click Live .	1-7
Fig. 14. Plugging-in a Multi-Media unit.	2-5
Fig. 15. Connect each camera to a different camera input (an "IN", in the VIDEO INPUTS section), on the back-panel.	2-6
Fig. 16. Temporary use of a PC onsite.	2-11
Fig. 17. Wiring diagram of a null modem cable	2-11
Fig. 18. Naming a connection, using <i>HyperTerminal</i>	2-12
Fig. 19. Indicating a PC's COM Port, using <i>HyperTerminal</i>	2-12
Fig. 20. Detail of "TELCO" port, used for dial-up connection.	2-15

Fig. 21. Upgrading a unit in the field.	2-17
Fig. 22. In organizations where security is a high priority, <i>Admin</i> is not installed on all PCs. The PCs of View operators do not need <i>Admin</i> .	3-1
Fig. 23. Icon for Admin on the Windows desktop	3-3
Fig. 24. You can add Rapid Eye site information to an empty Multi db, using the Microsoft Access engine, to test connections to Rapid Eye sites.	3-4
Fig. 25. Type the site name of your choice in the Add Site dialog.	3-5
Fig. 26. The “-> Dialup” in the connection name iappears as you click <i>Use Dial-up Networking</i> .	3-7
Fig. 27. Dial-up making irregular use of area codes occurs when a local call is used across area codes or when a long distance call is needed to dial-up in a local area code. This can fool Microsoft Windows’ <i>Dial-Up Networking</i> application. You can set Multi to remedy this.	3-7
Fig. 28. Adding a pilot connection	3-8
Fig. 29. View icon	3-9
Fig. 30. Your database can have the name of your choice, as long as it is the same one used earlier, as in figure 24 on page 3-4.	3-10
Fig. 31. A connection works when you see the “System operational” message in the Feedback box. It should appear after selecting a site and clicking Maintain.	3-11
Fig. 32. Indicating the correct Time Zone in which a Multi-Media unit has been installed is crucial to avoiding confusion during the operation of your video surveillance system.	3-12
Fig. 33. Different rules for daylight savings time in one time zone.	3-13
Fig. 34. Time tab indicating that a Multi-Media unit’s clock could be synchronized to your PC’s clock.	3-15
Fig. 35. Video tab in Maintenance session: video feed adjustments.	3-15
Fig. 36. Live video from a camera, renamed to “side entrance”, at a site called: “Foucault facility, 232”.	3-16
Fig. 37. Audio input to Multi-Media unit.	4-1
Fig. 38. Speaking remotely from a PC running View, or onsite using LocalView, an operator can communicate with people at the site.	4-2
Fig. 39. Audio tab, set to deliver sound to and from the View operator’s PC to two channels of audio, at one Multi site.	4-3
Fig. 40. Removing the camera input/output (I/O) connectors.	5-2
Fig. 41. Handle on mounted hard disk.	5-3
Fig. 42. Pull to remove a mounted hard disk from a unit; push to insert. Remove the front cover of the unit beforehand.	5-3
Fig. 43. PTZ wiring plan	5-4
Fig. 44. Video tab: PTZ settings.	5-5

Fig. 45. Input configuration during a maintenance session. By default, alarm/control inputs are configured as NO.	5–7
Fig. 46. Schematics: (a) normally open, (b) normally closed or (c) end-of-line	5–7
Fig. 47. Settings for monitoring a unit.	5–9
Fig. 48. FAULT RELAY connector on Multi-Media unit's back-panel, showing connection to an external alarm panel.	5–10

7.4 More FAQs

In Europe, a UPS is required to meet EN50130–4 Euro Norm.	1–3
Effective video feeds are a major component of any CCTV system.	1–8
Please do not remove factory seals on a Multi-Media unit.	2–1
Do not connect USB devices or a printer to a Multi-Media unit.	2–3
In Europe, a UPS is required to meet EN50130–4.	2–4
Honeywell recommends that a line conditioning uninterruptible power supply (UPS) be used with the Multi-Media unit and the <i>cameras connected to the unit</i> .	2–5
If cameras are turned on <i>after</i> the Multi-Media unit, they will not be auto-detected by the unit.	2–5
Honeywell recommends powering down a unit before connecting hardware to it. See 2.4.1: <i>Powering Up and Down</i> , p. 2–5.	2–6
Lens selection and angle of the camera can be critical to the usefulness of images obtained in a closed circuit television (CCTV) system.	2–7
Honeywell recommends powering down a unit before connecting hardware to it. See 2.4.1: <i>Powering Up and Down</i> , p. 2–5.	2–7
PTZ configuration and control are not currently supported in LocalView. PTZ configuration and control are fully supported when using View software.	2–7
Select a VGA monitor to run LocalView only if the monitor supports a resolution of 800 × 600.	2–8
Placing a monitor or other equipment directly on top of the Multi-Media unit is not recommended.	2–8
Do not use re-writable compact discs (CD-RW) or recordable digital video discs (R-DVD) to store Multi-Media video clips.	2–8
Please make a note of passwords. A lost password can make the LocalView interface unchangeable.	2–9
The LocalView passwords have no effect on other passwords, set using Admin software. See the <i>Admin User Guide</i> for procedures involving other passwords.	2–9
Within DHCP without DNS, an assigned IP address needs to be reserved or it may change.	2–10
Setting an IP address is only needed for a connection to a network.	2–10
A null-modem cable comes with your Multi-Media unit.	2–11

After 10 minutes of inactivity, the Multi-Media Shell times out.	2-13
After 10 minutes of inactivity, the Multi-Media Shell times out.	2-15
Honeywell recommends powering down a unit before connecting hardware to it. See 2.4.1: <i>Powering Up and Down</i> , p. 2-5.	2-15
Connect the unit to a telephone line only if a dial-up connection is used to communicate with the Multi-Media unit. For a network connection, please skip to 2.7: <i>Network Connection</i> .	2-15
You need Administrator rights to install <i>View</i> to run on Windows 2000, NT or XP.	3-2
Installing Multi software is also explained in the <i>Operator Software Setup Instructions</i> .	3-2
Some versions of Windows need you to restart the PC.	3-2
You do not need to create a db each time that you log on.	3-3
Choose a name for your Multi db that avoids:	3-3
You do not need to create a db each time that you log on.	3-4
For a dial-up only connection, leave the IP Address box empty.	3-6
To access an outside line.	3-6
The IP Address is mandatory for a network connection.	3-8
Ports 10,000, 10,001 and 10,003 should be left open in your organization's firewall.	3-9
Setting the Time Zone of a unit is crucial for correctly reporting the video of events.	3-11
The time zone is set on a unit-by-unit basis.	3-12
Auto-synch statistics do not apply to a clock set to Manual.	3-14
Honeywell recommends that speakers be placed away from microphones, to avoid audio feedback.	4-2
Use the "[Audio] In" connector. The "Mic In" connector is disabled.	4-2
Loud alarms should be tested during the installation; they can interfere with Multi-Media audio. If microphones and speakers are used while alarm bells are ringing, Honeywell recommends that Multi-Media audio equipment be sonically insulated from the loudness of the alarms.	4-2
The Audio tab is unavailable on PCs without a soundcard.	4-3
Loud alarms can interfere with microphones or a speaker at times when they could be needed most.	4-3
Before adding more hardware, Honeywell recommends that you test the connection to your unit, as explained in section 1.	5-1
Do not block the air intakes on the side of a Multi-Media unit.	5-2
Placing equipment, such as a monitor, directly on top of the Multi-Media unit is not recommended.	5-2
Communicate the address used by the PTZ to the Multi SA, after the installation.	5-4
Honeywell recommends that cable not be "T-tapped"; this can introduce unwanted distortion into the video signal.	5-5
To avoid short-circuits, ensure that bare wire is not visible at the rear panel.	5-6

Up to 24 mA can be drawn at each output.	5-8
To avoid short-circuits, ensure that bare wire is not visible at the rear panel.	5-8
Do not connect a device to CONTROL output 6 after enabling the FAULT RELAY.	5-10
For an external modem with a POTS-based Multi-Media unit, contact oneywell Video Systems technical support, at: 1 (800) 796-2288; i.e., 1 (800) 796-CCTV.	5-10
Do not connect devices to the USB ports or to the parallel port of a REMM unit.	5-11
Do not remove the third wire on a three-prong electrical plug	6-3

7.5 Site Information Checklist

Organization personnel

Personnel	Name, telephone #, email
Installer	
Multi SA	
Network Administrator	
Onsite personnel	
Emergency / after hours	

- checklist continues on next page -

Site definition

Rapid Eye site...	Identification
Name	
Serial number	
Time zone	
Street address	
Multi-Media unit location: floor, room, area...	
SNTP servers (optional)	primary: secondary:
System password	changed?
FAULT RELAY	enabled?

- checklist continues on next page -

Communications to unit

Connection	Value
Type - Network, Dial-up or both	
Network IP address	
Dial-up remote access service (RAS) server (yes/no)?	
Unit telephone number/RAS server telephone number	
Area code	
Area code is used normally (yes/no)?	
Country code	

Audio

#	Microphone type	Speaker type	Comments
1			
2			

- checklist continues on next page -

Video camera configuration

#	Color / B&W / none	Camera model, location	PTZ address
1			
2			
3			
4			
5			
6			
7			
8			
9			
10			
11			
12			
13			
14			
15			
16			

- checklist continues on next page -

Sensor hardware

Input	Type (NO, NC, EOL)	Description
1		
2		
3		
4		
5		
6		
7		
8		
9		
10		
11		
12		
13		
14		
15		
16		

- checklist continues on next page -

Control outputs

Output	Description
1	
2	
3	
4	
5	
6	
7	
8	

Serial ports

Port	Use: external modem, PTZ controller, POS hardware...	Comment / parameters
1		
2		

- checklist continues on next page -

Point of sale hardware

Type	Name / model #	Data / text of interest

8 Index

A

ADEMCO PTZ driver. See Javelin/ADEMCO
administrator, Multi. See Multi SA
alarm bell, and audio interference, 4–3
alarm panel, 5–9
alarm sensor, connecting, 5–6
amplifier: audio, 4–1; video signal, 6–3
area code, irregular use, 3–7
audience: field work, 2–1; testing connections, 3–1
audio: configuration, 4–3; LocalView, 4–3;
monitor, 4–3; record, 4–3; talk to site, 4–3

B

base port, 3–9
best practices, CCTV. See Kruegle
blind spot: vehicle docking, 2–7
BNC connector, 2–6
Butterworth–Heinemann Publishing. See Kruegle

C

cable: audio, 4–1; coaxial, 6–3; triaxial, 6–4
cable length limit table, 6–3
camera: auto-detection, 3–16; naming, 3–16
camera lens, hampered by: blind spot, 2–7;
condensation, dust or grease, 2–7, 5–1;
strong or weak lighting, 2–7
Canada, 3
CCTV: audio, and, 4–1; best practices. See
Kruegle; planning, 6–2; reference, 6–2
checklist: hardware kit, 2–2; site identification,
3–5; software kit, 2–2
clock: Multi-Media unit, 3–11; Refresh button,
SNTP server, 3–13; setting to automatic, 3–13
coaxial cable: checklist, 6–3
commands: Multi Shell table, 2–14
condensation, on camera lens, 2–7, 5–1
configuration: camera, 3–16; input, hardware, 5–6
connection: checklist, 3–17; dial-up, 3–6; field
testing, 2–16; network, 3–8; reason for testing,
3–1; record in database, 3–6
converter for PTZ, 5–4

D

daisy-chain of multiple domes, 5–4
damaged unit, 2–16
darkness, and camera lens, 2–7
database: at logon, 3–4, 3–10; empty, 3–4; for
installation, 3–3; for testing connection, 3–3, 3–4,
3–10; for upgrades, 3–3; populated, used for
installation, 3–3
Defensible Space. See Newman
Delta PTZ driver, 5–5
detachable sub-panel, 5–2
DHCP, 2–9
dialing area code, 3–7
dial-up connection: avoiding area code
confusion, 3–7; field testing, 2–16; making a
record of, 3–6
dust, on camera lens, 2–7, 5–1
Dynamic Host Configuration Protocol. See DHCP.

E

empty database, 3–4
EOL (end-of-line) sensor, 5–7
EuroNorm, 3, 1–3

F

FAQs: installation support, 6–1; list of, 7–5; walk
through of installation, 1–2
FAULT RELAY, 5–8; alarm-panel, 6–2
FCC, 3
feedback, audio, 4–2
Find-it lists, 7–1
firewall ports, 3–9

G

grease, on camera lens, 2–7, 5–1
Greenwich Mean Time. See UTC
ground: loop, 6–3

H

Honeywell: web site, 1–7
how to.... See Knowledge Base
Hyperterminal: launch command table, 2–13

I

Illustrations, list, 7-3
Industry Canada, 3
input, sensor hardware: configuring, 5-6; NC.
 See normally closed sensor; NO. See normally open sensor
installation: main steps, 1-1; report contents, 2-4;
 reporting, to whom, 2-4; walk through, 1-2
interference, electrical, 6-4
IP address: assigned using LocalView, 2-10
IP address, assigning to unit, 2-13
ISDN, 5-10

J

Javelin/ADEMCO PTZ driver, 5-5

K

Kalatel PTZ driver/Cyberdome, 5-5
kit: hardware, 2-2; software, 2-2
Knowledge Base, 7-1
Kruegle, Herman, 1-8, 2-7, 6-2

L

lighting, 6-4
Local UI. See LocalView
LocalView, 2-10; audio, 4-3; monitor, 2-8;
 password, default, 2-9; recording rates, low, 2-9
log on: database, 3-4, 3-10; double duty dialog,
 3-4; password, 3-3, 3-10; user account, 3-3

M

Macmillan Publishing. See Newman
maintenance: Admin documentation, 1-7;
 Feedback box, 2-6; illustration, 1-6; running a
 session, 3-10
maintenance session: check auto-detection of
 cameras, 3-1; security validation, 3-9
maintenance session, running, 3-10
microphone, 4-1
modem: default settings table, 2-16; external,
 5-10; internal, Multi, 2-16
monitor: audio, 4-3
Multi db: create, 3-4
Multi SA (Multi-Media system administrator), 2-4;
 setting time zone on Multi-Media unit, 3-11;
 synchronizing clock on Multi-Media unit, 3-14
Multi Shell: commands table, 2-14; quitting, 2-
 14; returning to, 2-10, 2-11, 2-15; time out,
 2-10, 2-11, 2-15; using, 2-13
Multi software, installing, 3-2
Multi-Media unit clock. See clock, on unit

N

NC (normally closed) sensor, 5-7
network connection: field testing, 2-16; making
 a record of, 3-8
network settings: Multi default table, 2-14
Newman, Oscar, 1-8
NO (normally open) sensor, 5-7
noise: alarm bell, 4-3; audio, 4-2; loud alarm, 4-3
null-modem cable, 2-11

O

obtain video, 3-16
Orbiter dome, 5-5
output: connection, 5-8

P

panel connectors table, 2-3
part number: hardware kit, contents, 2-2;
 software kit, contents, 2-2
password: Administrator account, 3-4;
 at logon, 3-3, 3-10; LocalView, 2-9
PC, in the field, 2-11
Pelco P/D PTZ driver/dome, 5-5
PING, 2-16, 3-6
power down, sequence, 2-5
power up, sequence, 2-5
protected sensor. See end-of-line sensor
PTZ: cabling table, 5-4; RS-232/485 converter, 5-4

R

RapidDome, 5-5
RAS server, 3-7
rear panel connectors, 2-2
record: audio, 4-3
recovery: power-down, 2-6
Refresh button, SNTP server, 3-13
report installation: content, 2-4; to whom, 2-4
return authorization, 2-16
Ringer Equivalence Number (REN), 3
road map: adding hardware, 5-1;
 all software, 3-1; field work, 2-1
rush-hour, noise from, 4-2

S

screwdriver, 5-8
security: TCP ports table, 3-9
sensor hardware table, 5-8
sensor, alarm. See input, sensor hardware
Sensormatic dome, 5-5
site: as unit, 3-5; new, naming, 3-5

site information, checklist, 2-1, 2-4, 6-1, 7-8
SNTP Server. See clock
soundscape, 4-2
speaker, audio, 4-1
spot checking: audio, 4-2
stadium crowd, noise from, 4-2
sub-panel, detachable, 5-2
sunlight, on camera lens, 2-7
synchronizing unit time to PC, 3-12, 3-14
System administrator, Multi. See Multi SA
system monitoring. See FAULT RELAY

T

Tables, list of, 7-2
TCP ports: base, 3-9; table, 3-9
telephone jack, 2-15
terminal program, 2-11
time zone, 3-5; Multi-Media unit, 3-11
time zone conflict, 3-12
triaxial cable, 6-4
TTL, 2-3

U

Ultrak PTZ driver, 5-5
unit: default network settings, 2-14; if damaged, 2-16; maintenance session, 3-10; recovery, 2-6; securing, 5-1; time zone, 3-5; unpacking, 2-1
upgrade: software, 3-2
UPS: recommended, 2-4
user account, at logon, 3-3, 3-10

V

vehicle docking, blind spot, 2-7
ventilation, 5-1
video, obtaining, 3-16
View operator: audio at PC, 4-3; time zone conflict, 3-12

W

web site, 1-7
Windows 2000, 3-2
wire stripper, 5-6, 5-8

Honeywell Video Systems

171 Eileen Way
Syosset, NY 11791, USA
www.honeywellvideo.com
TEL 1-800-796-CCTV
TEL+1-516-921-6704

Honeywell Security Australia Pty Ltd.

Unit 5, Riverside Centre, 24-28 River Road West
Parramatta, NSW 2150, Australia
www.ademco.com.au
TEL +61-2-8837-9300

Honeywell Security Asia Pacific Ltd.

Flat A, 16/F, CDW Building
388 Castle Peak Road
Tsuen Wan, N.T., Hong Kong
www.ademco.com.hk
TEL +853-2405-2323

Honeywell Security France

Parc Gutenberg, 13, Voie La Cardon
91120, Palaiseau, France
www.ademco.fr
TEL +33-1-6932-1090

Honeywell Security Italia SpA

Via della Resistenza 53/59, 20090 Buccinasco
Milan, Italy
www.ademco.it
TEL +39-02-457-1791

Honeywell Security Espana

Calle Vivero, 5, 28040
Madrid, Spain
www.ademco.es
TEL +34-91-533-4706

Honeywell Security House (Netherlands)

Amperestraat 41
1446 TR Purmerend, Netherlands
www.SecurityHouse.nl
TEL +31-299-419-000

Honeywell Video Systems UK Ltd.

Aston Fields Road, Whitehouse Ind Est
Runcorn, Cheshire, WA7 3DL, UK
www.videocontrols.co.uk
TEL +44-1928-754-000

Honeywell Security South Africa

Unit 6 Galaxy Park, Galaxy Avenue,
Linbro Business Park
P.O. Box 59904, Kengray, 2100, South Africa
www.honeywell.co.za
TEL +27-11-574-2500

Honeywell Security Germany

Großenbaumer Weg 8
40472 Düsseldorf, Germany
www.ultrak.com
TEL +49-211-415-090

Honeywell Security Poland

Chmielewskiego 22a, 70-028
Szczecin, Polska
www.ultrak.pl
TEL +48-91-485-40-60

Honeywell Security Czech Republic

Havránkova 33, Brno
Dolní Heršpice, 619 00, Czech Republic
www.olympo.cz
TEL +420-543-558-111

Honeywell Security Slovakia Republic

Vajnorská 142, 83104 Bratislava
Slovakia
www.olympo.cz
TEL +421-2-444-54-660

Honeywell

© 2004 Honeywell International Inc.

All rights reserved. No part of this publication may be reproduced by any means without written permission from Honeywell Video Systems. The information in this publication is believed to be accurate in all respects. However, Honeywell Video Systems cannot assume responsibility for any consequences resulting from the use thereof. The information contained herein is subject to change without notice. Revisions or new editions to this publication may be issued to incorporate such changes.



K9696V2 12/04 – Rev. B

Free Manuals Download Website

<http://myh66.com>

<http://usermanuals.us>

<http://www.somanuals.com>

<http://www.4manuals.cc>

<http://www.manual-lib.com>

<http://www.404manual.com>

<http://www.luxmanual.com>

<http://aubethermostatmanual.com>

Golf course search by state

<http://golfingnear.com>

Email search by domain

<http://emailbydomain.com>

Auto manuals search

<http://auto.somanuals.com>

TV manuals search

<http://tv.somanuals.com>