

HP Digital Entertainment Center User's Guide



i n v e n t

The only warranties for HP products and services are set forth in the express warranty statements accompanying such products and services. Nothing herein should be construed as constituting an additional warranty. HP shall not be liable for technical or editorial errors or omissions contained herein.

HP assumes no responsibility for the use or reliability of its software on equipment that is not furnished by HP.

This document contains proprietary information that is protected by copyright. No part of this document may be photocopied, reproduced, or translated to another language without the prior written consent of HP.

Hewlett-Packard Company
P.O. Box 4010
Cupertino, CA 95015-4010
USA

Copyright © 2004–2006 Hewlett-Packard Development Company, L.P.

May be licensed in the United States by one or both of U.S. Patents Nos. 4,930,158 and 4,930,160 until August 28, 2008.

FireWire is a trademark of Apple Computer, Inc.

HP supports lawful use of technology and does not endorse or encourage the use of its products for purposes other than those permitted by copyright law.

Intel, Pentium, Intel Inside, and the Intel Inside logo are trademarks or registered trademarks of Intel Corporation or its subsidiaries in the United States and other countries/regions. Microsoft, the Microsoft logo, Windows, and Windows XP are U.S. registered trademarks of Microsoft Corporation.

The information in this document is subject to change without notice.

Warnings and Notes

Color-coded warnings and notes with additional text contain important information.

Sample warnings and notes are displayed on this page.



A warning describes information you need to avoid possible personal injury, damage to equipment, or irrecoverable data loss.

Text set off in this manner indicates that failure to follow directions could result in bodily harm or loss of life.

Read and follow all warnings.



A note describes important information you need.

Table of Contents

Before You Begin	1	Connecting Audio	33
Welcome.....	1	Audio Overview	34
Benefits and Features	2	Audio Output Connectors	34
Functional Overview	3	Sound Connector Jacks.....	35
Front Panel	3	Speaker Types.....	35
Memory Card Reader	5	Speaker Configurations	36
Back Panel.....	6	Typical Audio Connection	38
Cleaning the HP Digital Entertainment Center	9	TV Audio Connection	39
Keyboard	10	Connecting TV Audio	39
Wireless Keyboard Operation.....	12	AV Receiver Audio Connection.....	40
Replacing the Keyboard Batteries	13	AV Receiver Equipment Overview	40
Remote Control	14	2.0 Home Stereo Installation	41
Remote Control Buttons.....	14	2.1 Home Stereo Installation	42
Remote Control Operation	16	4.1 Home Theater Audio	43
Installing the Remote Control Batteries	16	5.1 Home Theater Audio	44
Safety Information.....	17	7.1 Home Theater Audio	45
AC Power Safety Warnings	17	Digital Home Theater Audio	46
Installation Overview	19	Powered Speaker Audio Connection.....	48
System Audio/Video Connections	20	2.1 Powered Speakers	49
System Integration	20	4.1 Powered Speakers	50
System Diagram	22	5.1 Powered Speakers	51
Installation Guidelines.....	24	7.1 Powered Speakers	52
Placement and Ventilation Requirements	25	Digital Powered Speakers	53
Basic Setup	27	Monitor Speakers	54
Setting Up the HP Digital Entertainment Center	27	Audio Out Connections.....	55
Inventory	29	FM Radio Antenna	56
Cables Included	30		

Connecting Video Out..... 57

Video Out Overview.....58

Video Out Connection Overview	58
Video Out Connectors.....	59
Component Video Settings.....	60
TV Display Overview	60
Audio and Video Switching Overview.....	61
Using the Remote Control with Your TV	61

Typical Video Out Connections62

Video Out to TV63

Video Out from AV Receiver to TV65

Video Out to Monitor67

Video Out to TV and Monitor68

Connecting TV Source In 71

TV Source Overview72

TV Signal Source Overview	72
Additional HDTV Information	74
TV Source Connectors Overview	75
TV Source Connectors	76

Typical TV Source Connections.....78

Antenna Connection.....80

Antenna (NTSC)	80
Antenna (ATSC)	81
Antenna (NTSC and ATSC).....	82

Cable Connection..... 83

Cable (NTSC) and Antenna (ATSC)	83
One Cable TV Box or Digital Cable Receiver (NTSC) and Antenna (ATSC).....	84
Two Cable TV Boxes, or Two Digital Cable Receivers (NTSC) and Antenna (ATSC).....	86
Cable Only (NTSC).....	88
One Cable TV Box or Digital Cable Receiver (NTSC).....	89
Two Cable TV Boxes, or Two Digital Cable Receivers.....	91

Satellite Connection 93

One Satellite Receiver (NTSC)	93
Two Satellite Receivers (NTSC)	95

Infrared Transmitter Connection..... 97

Infrared Transmitter Overview	97
Infrared Transmitter Installation	99

Connecting Video Equipment..... 101

Video Equipment Overview 102

Connectors	102
Video Equipment Connection Overview.....	103

Typical Video Equipment Connections 104

VCR Connection 105

VCR Direct In Connection	105
Wall to VCR to TV Using Coaxial Cable.....	106

Video Camera Connection 109

Connecting a Digital Video Camcorder	109
Connecting an Analog Camcorder	112

Connecting the Network	113	Configuring Video.....	140
Peripheral Connection Overview	114	Configuring Video Output.....	140
Typical Network Connections	116	Dual screen.....	140
Connecting the Wireless Network		Adjusting the Desktop Display	143
Antenna	117	Adjusting the Display in Media Center	144
Connecting a DSL/Cable Modem.....	119	DVD Playback.....	145
Connecting Through a Router	120	Adjusting the Display from the Desktop.....	145
USB Device Connection	121	HDTV Overscan Configuration	147
Digital Still Camera.....	121	Finding ATSC HDTV and Standard	
Other USB Devices	122	TV Channels	148
Connecting an HP Personal		Tuning the Desktop Display	148
Media Drive	123	Configuring the System.....	150
Installing an HP Personal Media Drive.....	124	Configuring the Keyboard Buttons.....	150
Disconnecting an HP Personal Media Drive.....	125	Registering with HP	151
Initial Configuration	127	Setting Up Virus Protection	151
Starting the HP Digital Entertainment		Transferring Information from Your Old PC to	
Center for the First Time.....	128	Your HP Digital Entertainment Center	152
Installing the Keyboard Batteries (Initial)	128	Installing Software	153
Initial Startup.....	129	Utility Programs	153
Synchronizing the Keyboard	130	Troubleshooting.....	159
Windows Welcome	131	Problems and Solutions	160
Media Center First Run	132	Audio.....	160
Required Setup.....	132	Video	162
Optional Setup.....	132	System.....	164
If Your Connections Don't Work	133	Getting Help	170
Adjusting the Front Panel Display Brightness.....	134	Help and Support Center	170
Configuring Audio.....	135	HP Support	170
Connecting Headphones	135	Warranty and Support Guide.....	171
Connecting a Microphone	135	Updates from HP	173
Adjusting the Volume	136	Microsoft Web Site	173
Configuring Audio Output	138		

Replacing the Hard Disk Drive 175

Safeguarding Recorded TV programs..... 175

Before Replacing the Hard Disk Drive..... 175

Removing the Hard Disk Drive..... 176

Replacing the Hard Disk Drive..... 177

Index 179

Before You Begin

Welcome

Thank you for purchasing the HP Digital Entertainment Center. Your HP Digital Entertainment Center puts you in control of your complete home entertainment experience. Enjoy your TV, movies, music, photos, and home videos with one simple interface. Pause and replay live TV, and record your favorite TV shows. Use a television program guide without a monthly fee. Capture, personalize, and create DVDs of your home movies, and back up your photos, music, or favorite TV programs onto DVD.

Use other entertainment equipment — like a TV, AV receiver, satellite receiver, and digital camera — with the HP Digital Entertainment Center to create an integrated system. Access all of your TV programs, videos, pictures, music CDs, and DVDs using Microsoft® Media Center software and the remote control.

This *User's Guide* helps you to set up the HP Digital Entertainment Center to use with your audio/video system.

It is a good idea to keep the original packaging box in a storage area. You may need it later if you move or ship your HP Digital Entertainment Center.

Chapter Contents:

"Functional Overview" on page 3

"Keyboard" on page 10

"Remote Control" on page 14



The HP Digital Entertainment Center

Benefits and Features

Benefits

- Complete home digital entertainment solution for your living room.
- Watch, pause, and replay live TV on one channel while recording another (select models only).
- Schedule future recordings with the complimentary TV programming guide (no charge — separately purchased broadband Internet service required).
- Burn a DVD of your favorite TV shows or home videos.
- Play DVDs in 7.1 surround sound (surround sound system is required and sold separately).
- Burn music audio CDs (for lawful use only).
- Burn your audio CDs to your hard disk drive to create an easy-to-use music jukebox.
- Listen to your collection of MP3 and AAC music.
- Burn picture slide shows to CD or DVD.
- View and edit your favorite digital photos.
- Store your digital content on the HP Personal Media Drive which is sold separately.
- Download movies on demand (fees may apply — separately purchased broadband Internet service required).
- Instant-message friends (separately purchased broadband Internet service required).

Product features

- Sophisticated, sleek, stackable case fits into your AV cabinet
- Built-in standard-definition TV tuner, NTSC (Dual tuners for select models only)
- Built-in high-definition ATSC HDTV tuner (select models only)
- Personal video recorder (PVR) with a complimentary TV programming guide (no charge) (Internet required)
- Built-in FM radio tuner
- HP Personal Media Drive Bay (The HP Personal Media Drive is sold separately.)
- Front panel media info display
- CD/DVD double-layer, multi-format player/recorder
- 9-in-1 media card reader
- Rear and front AV connectors:
 - Digital Audio Out: Optical and coaxial S/PDIF 5.1 surround
 - Analog Audio Out: Up to 7.1 channels
 - Video Out: HDMI, VGA, component video
 - LAN Ethernet 10/100/1000
 - Integrated 802.11 a/b/g wireless
 - Front AV, USB, and FireWire® (IEEE 1394) connectors for video capture
- Full function remote control
- Lap-sized, compact wireless keyboard with integrated trackball mouse

Functional Overview



Front Panel



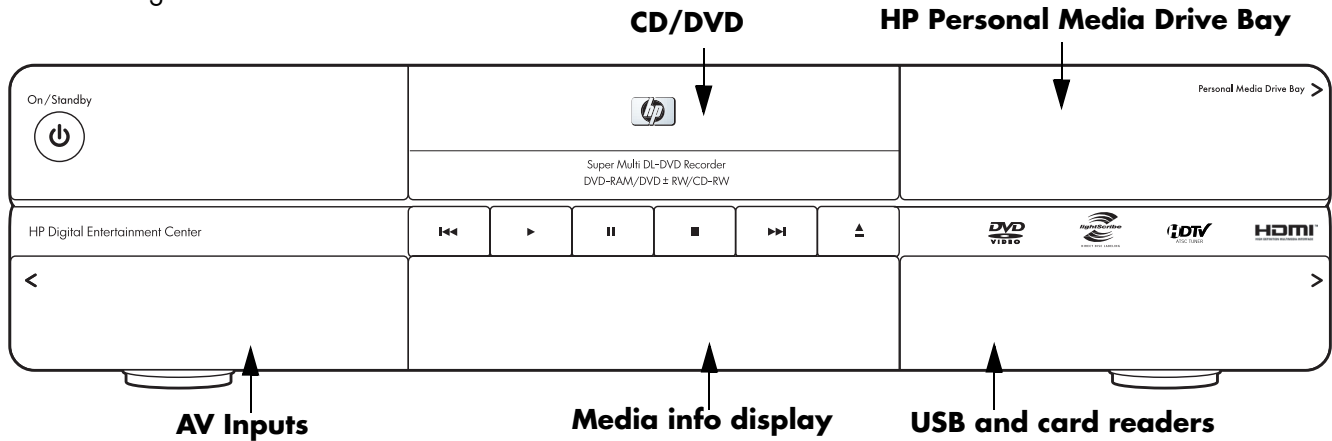





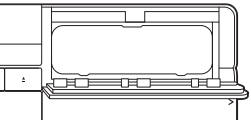

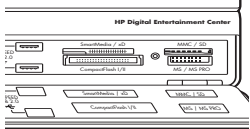
The following illustration shows a typical HP Digital Entertainment Center front panel.

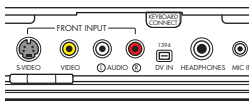
Your model might not have all features.



Front panel

Item	Function	Comments
	On/Standby (power) button and LED Push to turn on. Push for standby. Press and hold button 4 seconds to turn off.	Solid blue: On Solid amber: Standby
	CD/DVD player/recorder Progressive scan DVD player plus double-layer DVD+RW/DVD-R recorder	CD/DVD, multi-format Push the Eject button to open. Push the tray or Eject button to close.
	Transport control buttons	Replay, Play, Pause, Stop, Skip, Eject
	Personal Media Drive Bay	Removable HP Personal Media Drive behind top right door, for additional storage for recorded TV shows and digital content

Item (continued)	Function	Comments
	9-in-1 memory card readers SmartMedia/xD, MMC/SD, CompactFlash I/II, Microdrive, MS/MS-Pro USB 2.0 (2)	Card readers behind lower right door LED: Green (with media inserted) Off (no media inserted) See "Memory Card Reader" on page 5.
	Media info display	Front status panel for all media information. Front-panel text content displayed from Media Center
	<i>Behind left door</i> AV connectivity for capturing analog and digital video from camcorders	<i>Front AV inputs — see below</i>
	Keyboard connect switch for wireless keyboard synchronization	Blinking green LED indicates keyboard activity. Special blink status indicates synchronizing with keyboard.
	S-video In	Y/C video, analog 4-pin
	Video In	Composite video RCA jack
	Audio In	White: Left Red: Right, RCA jacks
	FireWire (IEEE 1394) DV In	FireWire (IEEE 1394), 4-pin input-output for digital video
	Headphone Out	1/4 inch jack
	Microphone In	1/8 inch mini-jack

Memory Card Reader

The HP Digital Entertainment Center 9-in-1 card readers are on the front panel, located behind a door for quick transfer of digital photos and other digital content. Four horizontal card slots accept memory cards.

An in-use light-emitting diode (LED) indicates card reader activity when the HP Digital Entertainment Center is reading or writing data. Wait until the LED stops blinking before removing media.

Digital cameras and other digital devices use memory cards, or media, to store digital picture files.

Two USB 2.0 connectors are also included.



Removing media when the in-use light is blinking may cause damage.

Your model might not have all features.

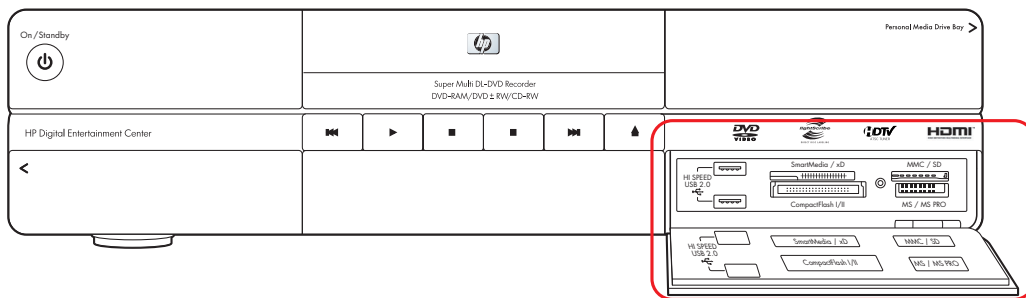

Memory card readers

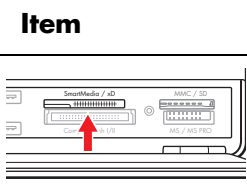
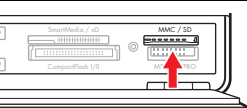
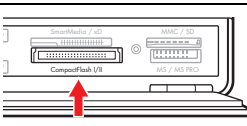
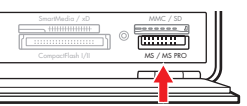
Item	Name	Slot	Supports	Insert media
	SmartMedia/xD	Upper-left	SmartMedia (SM) memory card/ xD media	Facing up
	MMC/SD	Upper-right	MultiMediaCard (MMC) Secure Digital (SD) memory card	Facing up
	CompactFlash I/II Microdrive	Lower-left	CompactFlash Type I, II media Microdrive disk drive	Receptacle edge (holes)
	MS/MS-Pro	Lower-right	Memory Stick (MS) Memory Stick (MS-Pro)	Facing up







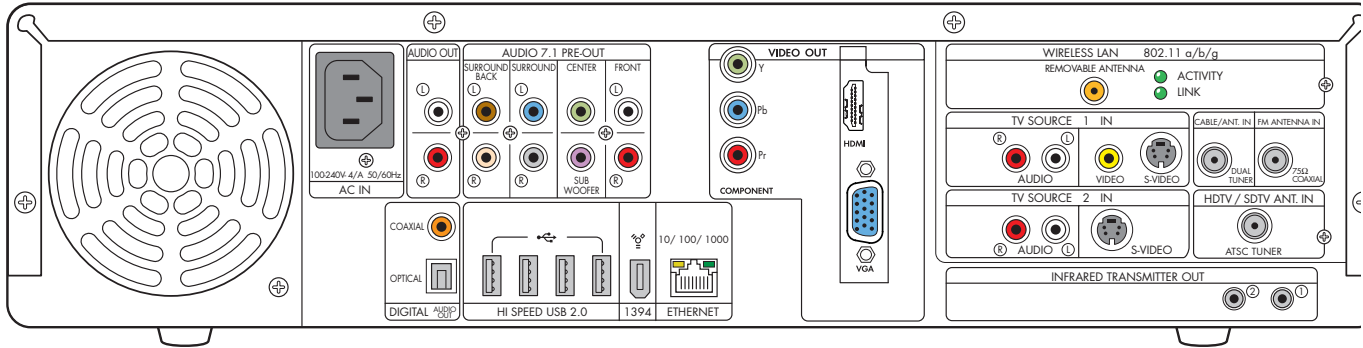

Before You Begin



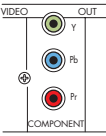
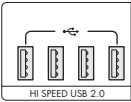





Back Panel

The following illustration shows the HP Digital Entertainment Center back panel.
(Location, availability, and number of connectors may vary.)



Item	Connector	Type	Color	Supported format
	Audio Out	RCA jacks	White: Left Red: Right	Analog stereo Adjustable line-level
	Audio 7.1 Pre-Out Surround Back	RCA jacks	Brown: Left Beige: Right	Analog: 7.1
	Audio 7.1 Pre-Out Surround	RCA jacks	Blue: Left Grey: Right	Analog: 7.1, 6.1, 5.1, 4.1
	Audio 7.1 Pre-Out Center/Subwoofer	RCA jacks	Green: Center Purple: Subwoofer	Analog: 7.1, 6.1, 5.1
	Audio 7.1 Pre-Out Front	RCA jacks	White: Left Red: Right	Analog stereo: 7.1, 6.1, 5.1, 4.1, 2.1, 2.0
	Digital Audio Out	Coaxial	Orange	S/PDIF

Item (continued)	Connector	Type	Color	Supported format
	Digital Audio Out	Optical	Gray	S/PDIF
	High Definition Multimedia Interface Out (HDMI) with audio	Type-A HDMI 19-pin	Silver/black	Digital: 480i/p, 780i/p, 1080i/p panning depending on display size
	VGA Out	15-pin D-sub	Blue	Analog: Up to 2048 x 1536 with panning depending on display size
	Component Video Out (Not all modes support DVD playback due to content protection.)	3 RCA jacks	Green: Y Blue: Pb Red: Pr	Analog: Interlaced or progressive scan interlaced displays up to 1080i, Plus 480p, 720p
	USB 2.0 (high speed)	4 ports	Silver	USB 2.0
	FireWire (IEEE 1394) (for digital video or other device)	6-pin DV input/output	Silver	FireWire (IEEE 1394)
	Ethernet 10/100/1000	RJ-45	N/A	10/100/1000
	Wireless LAN	Removable antenna	Gold	802.11 a/b/g
	LEDs (2) Activity: Blinks when transmits/ receives data	Link: Solid green when wireless LAN is enabled and connected. Blinks when wireless LAN is scanning.		Wireless LAN 802.11a/b/g
	Audio TV Source 1 In	RCA jacks	White: Left Red: Right	Analog
	Video (Composite) TV Source 1 In	RCA jack	Yellow	Analog: Up to 640 x 480 @ 60 Hz

Item (continued)	Connector	Type	Color	Supported format
	S-video TV Source 1 In	Y/C video Analog 4-pin	Black	Analog: Up to 640 x 480 @ 60 Hz
	Cable/Antenna In	Coaxial 75 Ohm	Silver	RF NTSC with internal splitter to dual-tuners
	FM Antenna In	Coaxial 75 Ohm	Silver	FM radio, RF
	Audio TV Source 2 In (Select models only)	RCA jacks	White: Left Red: Right	Analog
	S-video TV Source 2 In (Select models only)	Y/C video Analog 4-pin	Black	Analog: Up to 640 x 480 @ 60 Hz
	HDTV/SDTV Ant. In (Select models only)	Coaxial 75 Ohm	Silver	RF ATSC (from UHF and VHF antenna)
	Infrared Transmitter Out (2 outputs)	1/8 inch mini-jack	Silver	Remote infrared (IR Blaster)
	AC In	AC 110–240V 50–60 Hz	Black	Power

Cleaning the HP Digital Entertainment Center

The HP Digital Entertainment Center is a high-quality device that requires special care when cleaning. To clean the HP Digital Entertainment Center, follow these steps:

- 1 Turn off the HP Digital Entertainment Center and connected equipment.
- 2 Unplug the HP Digital Entertainment Center from the wall outlet before cleaning.
- 3 Use a soft dry cloth for dusting.
- 4 Use a clean cloth dampened with warm water to wipe it clean. If sticker residue is present, use isopropyl alcohol or rubbing alcohol and a lint-free cloth to remove the residue.
- 5 Use a battery-powered vacuum to remove dust and buildup from the vents and the I/O ports on the sides and back of the system.
- 6 Plug in the HP Digital Entertainment Center.
- 7 Turn on connected equipment and the HP Digital Entertainment Center.



Do not use liquid cleaners or aerosol cleaners to clean your HP Digital Entertainment Center. Do not use benzene, thinner, ammonia, or any other volatile substances. These chemicals may damage your unit.

Cleaning the Keyboard and Trackball

Debris particles and oil can accumulate on, between, and beneath the keys of your keyboard and trackball.

- 1 Gently use a small battery-powered vacuum to remove debris particles that get between and beneath the keyboard keys. Use a low setting to avoid removing key caps and springs.
- 2 Use a clean, dry cloth and isopropyl alcohol to clean the buildup on the keyboard keys.
- 3 Rotate the trackball-cover ring counter-clockwise to remove the ring and release the trackball.



- 4 Rinse the trackball and cover ring with soap and warm water. Dry them with a lint-free cloth.
- 5 Clean the rollers for the trackball with a cotton swab dampened with isopropyl alcohol.
- 6 Replace the trackball and trackball-cover ring.

Keyboard





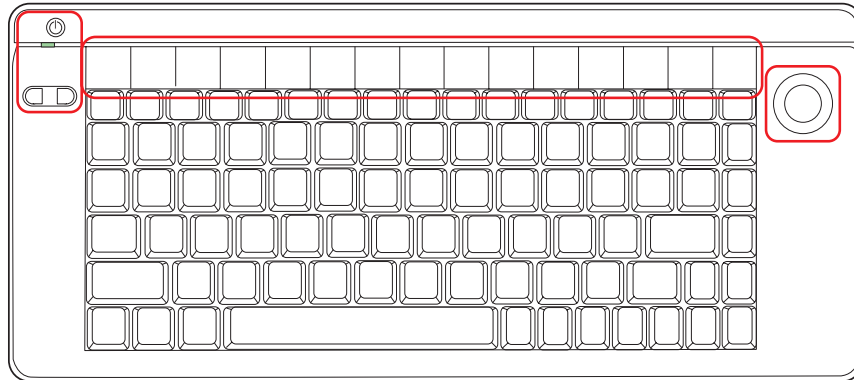

The following illustration shows the HP Digital Entertainment Center wireless keyboard.



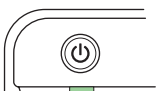
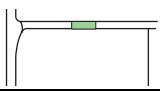
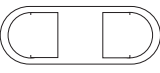





Left, right mouse button



TrackBall

The following table shows the wireless keyboard features and function keys from left to right.

Icon	Item	Description
	On/Standby	Turns HP Digital Entertainment Center on, when in standby. Places HP Digital Entertainment Center in standby.
	Indicator light	Amber: Caps Lock on Green: Key or mouse button activity
	Mouse button left, right	Left-click, right-click
	Back	Displays previously viewed Media Center or browser page.
	Forward	Displays next viewed browser page. This button is not designed to work in Media Center.
	Internet	Opens your Internet browser.
	E-mail	Opens an Internet e-mail page or your e-mail software.
	Messenger	Opens your instant messaging program.
	Minimize	Minimizes the Media Center application.

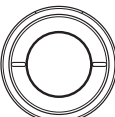
Icon	Item	Description
 Maximize	Maximize	Maximizes the Media Center application.
 Media Center	Media Center	Starts Media Center.
 Previous	Previous	Selects previous media track.
 Play	Play	Plays media.
 Pause	Pause	Pauses media.
 Next	Next	Selects next media track.
 Vol -	Vol -	Decreases speaker volume.
 Vol +	Vol +	Increases speaker volume.
 Mute	Mute	Turns speaker sound on and off.
	Trackball	Moves cursor on screen.

Replacing the Keyboard Batteries

Keep spare batteries on hand. Battery life will vary with the use of the system.

- 1 Slide the battery cover off the back of the keyboard.

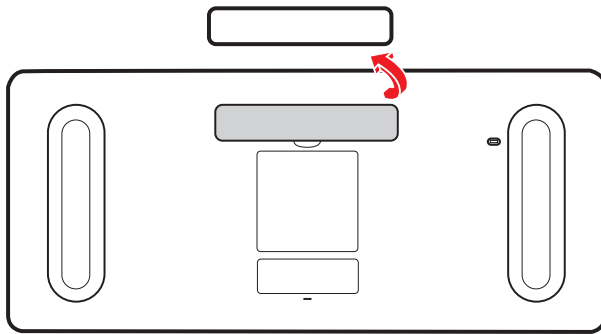

- 2 Insert four AA batteries (alkaline). Make sure the battery positive and negative ends are inserted correctly.

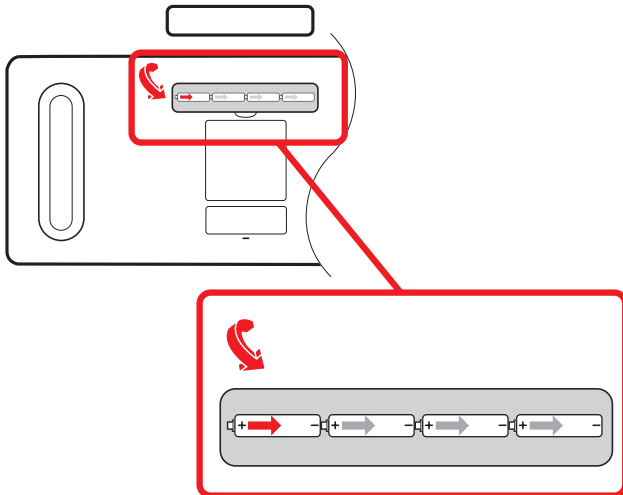

- 3 Replace the battery cover.

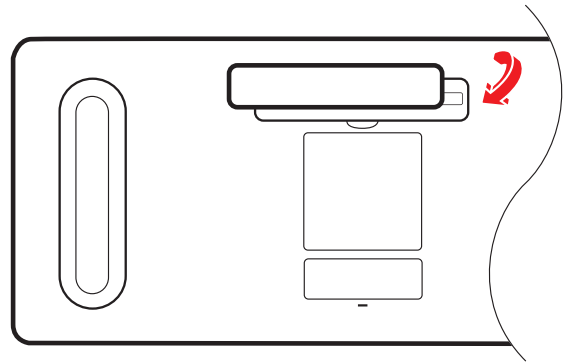





















- 4 Make sure the HP Digital Entertainment Center is powered on.
- 5 Test the keyboard.
 - The keyboard is set to connect to the HP Digital Entertainment Center automatically.
- 6 If the keyboard does not operate:
 - a Check the battery orientation.
 - b Synchronize the keyboard. See "Synchronizing the Keyboard" on page 130.

If you have no batteries and must use a keyboard, attach a USB keyboard to the back or front panel. You can also use the remote control for many functions as a temporary substitute.

Remote Control

Remote Control Buttons

(Features and location may vary. Refer to the specific documentation for other remote controls.)

A Quick Resume (Standby)	Puts the HP Digital Entertainment Center into and out of a reduced-power state. It does not turn the HP Digital Entertainment Center off.		L Media Center	Opens Media Center to the main menu.	
B DVD Menu	Opens Play DVD window in Media Center or opens the main menu of a DVD movie, if available.	DVD MENU 	M Volume	Increases (+) and decreases (-) sound.	VOLUME 
C Music	Starts My Music.	MUSIC 	N Live TV	Is a shortcut to view live TV. It also moves to the current point in a live TV program after pausing live TV.	LIVE TV 
D Radio	Starts FM Radio.	RADIO 	O Guide	Opens the Television Program Guide to display available TV channels and programs to watch and record.	GUIDE 
E Record	Records selected television program and stores it on the hard disk drive.	RECORD 	P Clear	Deletes the selection and works as the Backspace key does on a keyboard.	CLEAR 
F Rew	(Rewind) Moves the media backward (press button for three speeds).	REW 	Q TV	Starts My TV.	TV 
G Replay	Rewinds live or recorded TV back 8 seconds, or to beginning of music track or DVD chapter.	REPLAY 	R Pictures	Starts My Pictures.	PICTURES 
H Pause	Pauses audio and video tracks and live or recorded TV programs.	PAUSE 	S Videos	Starts My Videos.	VIDEOS 
J Back	Returns to the previous window within Media Center.	 BACK	T Play	Plays the selected media.	PLAY 
K Arrows	Buttons move the cursor to navigate within all Media Center windows. They also move forward and backward through slide-show images.		U Stop	Stops the selected media.	STOP 

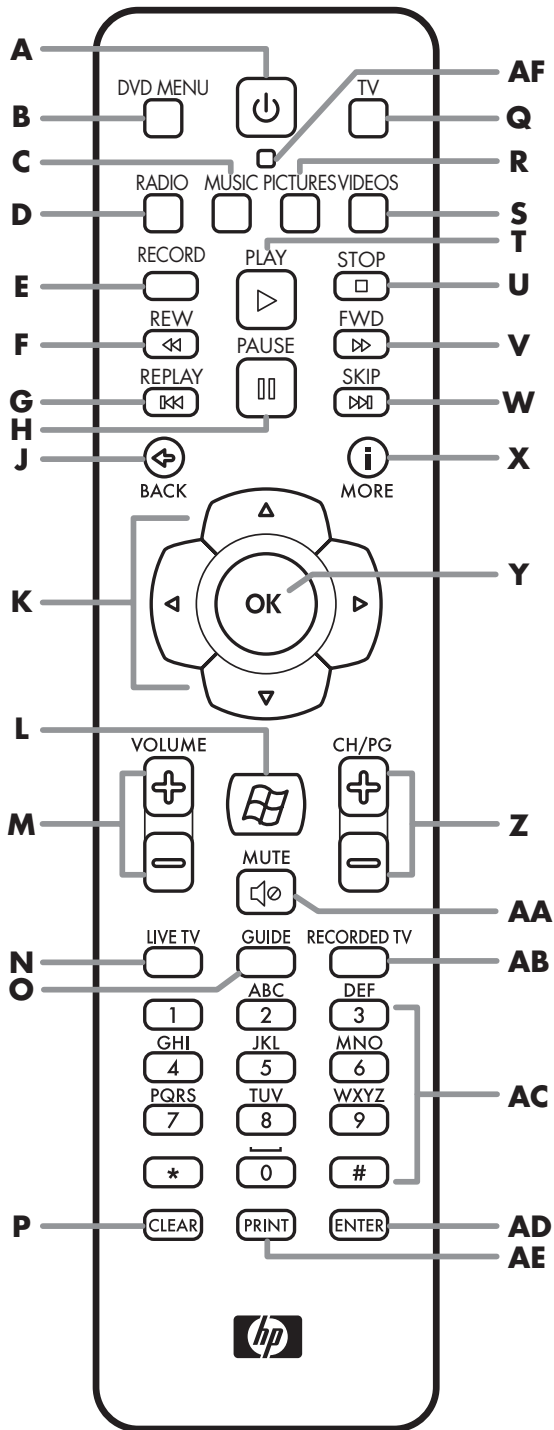

V Fwd	(Fast-forward) Moves media forward (press button for three speeds).	FWD
W Skip	Moves media forward — for example, 30 seconds in videos and live TV, one music track, or one DVD chapter.	SKIP
X More (i)	Displays available information about a selected media file and displays more information and options.	MORE
Y OK	Selects the desired action or window option. It acts as the Enter key. In full-screen mode, press OK to return to the last channel you were watching.	
Z CH/PG	Up (+) and down (-) change the TV channel or move pages up and down, depending on available options.	CH/PG
AA Mute	Turns sound off. The word <i>Mute</i> is displayed on the Media Center screen when Mute is turned on.	MUTE
AB Recorded TV	Opens the Recorded TV window.	RECORDED TV
AC 0 to 9, #, *	Numeric keypad buttons to change channels or enter text into the Media Center search or text box.	
AD Enter	Selects the desired action or window option. In full-screen mode, press Enter to return to the last channel you were watching.	ENTER
AE Print	Prints selected content on the screen.	PRINT
AF LED	Activity indicator lights on pressing a button.	

Remote Control Operation

Use the remote control to open the Media Center program; view TV, record TV programs, play previously recorded TV programs, and play music, movies, or video. See "Using the Remote Control" in the *HP Digital Entertainment Center Software Guide* for detailed instructions on using the features of the remote control.

To use the remote control, just point it at the HP Digital Entertainment Center and press a button. Use the remote control at a maximum distance of 26 feet (8 meters) from the remote sensor and at a maximum of 45 degrees (90 degrees total) from the center of the remote sensor.

The remote control will not operate until the HP Digital Entertainment Center is powered on and fully booted up.

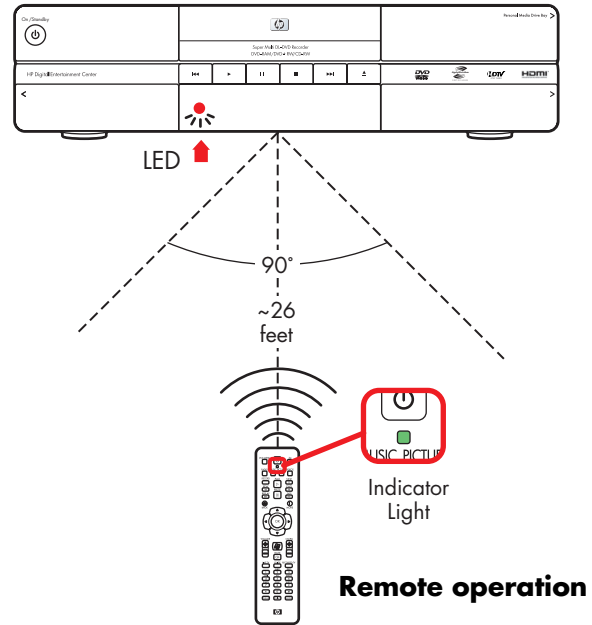

Media Center must be in full-screen mode (or have focus) for consistent remote control operation. Performance may vary.

Installing the Remote Control Batteries

- 1 Slide the battery cover off the back of the remote control.
- 2 Insert the two AA alkaline batteries (provided). Make sure the battery positive and negative ends are inserted correctly.
- 3 Replace the battery cover.
- 4 Test the remote control by pressing any key. The indicator light should blink.



Use only alkaline batteries in the remote.

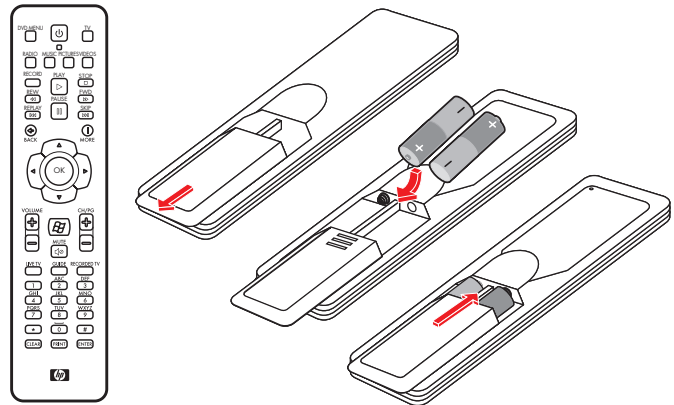

Safety Information

Read Instructions before installing or operating your HP Digital Entertainment Center.

Follow the instructions provided.

Heed all safety warnings and notes.

Refer to the *Warranty and Support Guide* for additional safety information.

Chapter Contents:

“AC Power Safety Warnings” on page 17



Please read this important safety information.



- **Do not open top cover.**
- **Risk of electric shock.**
- **No user-serviceable parts inside top cover.**

AC Power Safety Warnings

Use the right AC source. The power supply is preset for the country/region in which you purchased the HP Digital Entertainment Center. If you move to another country/region, please make sure you check its voltage requirements before plugging your HP Digital Entertainment Center into an AC power outlet.

A power cord is included with your HP Digital Entertainment Center. If another cord is used, use only a power source and connection appropriate for this HP Digital Entertainment Center.

Install the system near an AC outlet. The AC power cord is your HP Digital Entertainment Center’s main AC disconnecting device and must be easily accessible at all times. For your safety, the power cord provided with your system has a grounded plug. Always use the power cord with a properly grounded wall outlet to avoid the risk of electric shock.

To reduce the possibility of an electric shock from the telephone network, plug your system into the AC outlet before connecting it to the DSL/telephone line. Also, disconnect the DSL/telephone line before unplugging your system from the AC power outlet.

This product has not been evaluated for connection to an “IT” power system (an AC distribution system with no direct connection to earth, according to IEC 60950).

Ground your system. To reduce the risk of electric shock or damage to your equipment, do not disable the power cord grounding feature. The grounding plug is an important safety feature. Connect the equipment to a grounded (earthed) power outlet.

For your safety, be sure that the grounded power outlet into which you plug the power cord is easily accessible to the operator and is located as close to the equipment as possible.

Never pull on the cord. Disconnect the HP Digital Entertainment Center by grasping the plug firmly and pulling it from the power outlet. Never disconnect the HP Digital Entertainment Center by pulling the cord.

Install your HP Digital Entertainment Center near an outlet that you can easily reach. Do not allow anything to rest on the power cord. Do not walk on the cord.

Use surge protection. To protect your HP Digital Entertainment Center and other equipment, connect all power cords for your system and its peripheral devices (such as a printer or scanner) to a surge protection device such as a power strip with surge protection or Uninterruptible Power Supply (UPS).

Not all power strips provide surge protection; the power strips must be specifically labeled as having this ability. Use a power strip whose manufacturer offers a damage replacement policy so you can replace your equipment if surge protection fails.

Use the right power source. Use only a power source and connection appropriate for this HP Digital Entertainment Center, as indicated on the label/back plate of the HP Digital Entertainment Center.

Be sure the total ampere rating of the products connected to the outlet does not exceed the current rating of the electrical outlet, and the total ampere rating of the products connected to the cord does not exceed the rating of the cord. Look on the power label to determine the ampere rating (AMPS or A) for each device.

Outdoor antenna grounding — If an outside antenna or cable system is connected to the product, be sure the antenna or cable system is grounded so as to provide some protection against voltage surges and static buildup charges. Article 810 of the National Electrical Code, ANSI/NFPA 70, provides information with regard to proper grounding of the mast and supporting structure, grounding of the lead-in wire to an antenna discharge unit, connection to grounding electrodes, and requirements for the grounding electrode. Refer to the *Warranty and Support Guide* for additional safety information.

Lightning — For added protection of any HP product during a lightning storm, or when it is left unattended and unused for long periods of time, unplug the product from the wall outlet and disconnect the antenna or cable system. This will prevent damage to the product due to lightning and power line surges.

Power lines — An outside antenna should not be located in the vicinity of overhead power lines or other electric light or power circuits, or where it can fall into such power lines or circuits.

Installation Overview

This chapter provides information on your system and describes how to connect your HP Digital Entertainment Center to your audio/video (AV) equipment in detail. You may find connection details that won't be in the basic *Start Here* booklet.

The *Start Here* booklet and the TV/Display Setup Guide work with this *User's Guide*. Use the *Start Here* booklet and then the TV/Display Setup Guide before you read this chapter. You may find the information you need there.

The HP Digital Entertainment Center is very versatile and works with a wide variety of basic, typical, and advanced multimedia systems.

The installation process is divided into four major areas: Audio, Video, TV Source In, Network.

The setup can take some time, depending on your system, and may require additional cables.

Chapter Contents:

"System Audio/Video Connections" on page 20

"Basic Setup" on page 27

"Inventory" on page 29



Read the important safety information before you install the HP Digital Entertainment Center. See "Safety Information" on page 17.

System Audio/Video Connections

System Integration

The HP Digital Entertainment Center incorporates many functions into one unit:

- An **Internet** connection through a wireless or wired network, using an Internet service provider (sold separately), allows the HP Digital Entertainment Center to access the Television Program Guide and Internet content sources.
- A **cable** connection from a set-top box or antenna hookup (sold separately) allows the TV tuner inside the HP Digital Entertainment Center to select the TV channels.
- An **infrared transmitter** (IR blaster) connection to a set-top box from the HP Digital Entertainment Center allows the HP Digital Entertainment Center to select the set-top box channels from the HP Digital Entertainment Center remote control.
- **Audio** outputs from the HP Digital Entertainment Center to your TV speakers or AV receiver allow up to 7.1 surround sound.
- **Video** outputs from the HP Digital Entertainment Center to your TV or AV receiver allow you to watch TV and to view the HP Digital Entertainment Center display.
- An **FM** radio antenna connection allows the FM tuner inside the HP Digital Entertainment Center to select the FM radio channels.
- The wireless **keyboard** with **trackball** or **remote control** allows you to operate the HP Digital Entertainment Center from the comfort of your couch.

How you connect the HP Digital Entertainment Center into your system depends on how you want to use it. The HP Digital Entertainment Center functions as a media source, with DVD and personal video player/recorders built in. Your AV receiver or TV functions as your audio/video output switch.

To watch and record TV, video, and audio, you must first connect the HP Digital Entertainment Center inputs to your video, audio, and network sources.

- To play back audio/video, you must connect the HP Digital Entertainment Center outputs to your sound system and TV/display.
- To record audio/video, you must connect the HP Digital Entertainment Center inputs to your video source, such as a cable set-top box, satellite receiver, or antenna.
- To update the Television Program Guide and use the Internet, you must also connect to a home network or DSL/cable modem.

If your HP Digital Entertainment Center has the dual-tuner option, each tuner must be connected to the same TV source. You can connect two cable set-top boxes, or two, satellite receivers, or an antenna with cable splitter. The Television Program Guide only supports one TV service provider channel lineup.

Audio and video output cables from the HP Digital Entertainment Center can be:

- Routed through an AV receiver to provide an audio and video signal to your TV.

Or

- Routed directly to your TV.

Imagine the flow of your television signal into and out of the HP Digital Entertainment Center. To watch and record TV, your TV signal (for example, from a satellite) must flow into the HP Digital Entertainment Center. Then, for you to watch live or recorded TV, the HP Digital Entertainment Center must send the recorded TV shows out to your TV.

The following illustration shows the audio and video signal routed from the satellite or cable receiver source to the HP Digital Entertainment Center, then through an AV receiver to your TV:

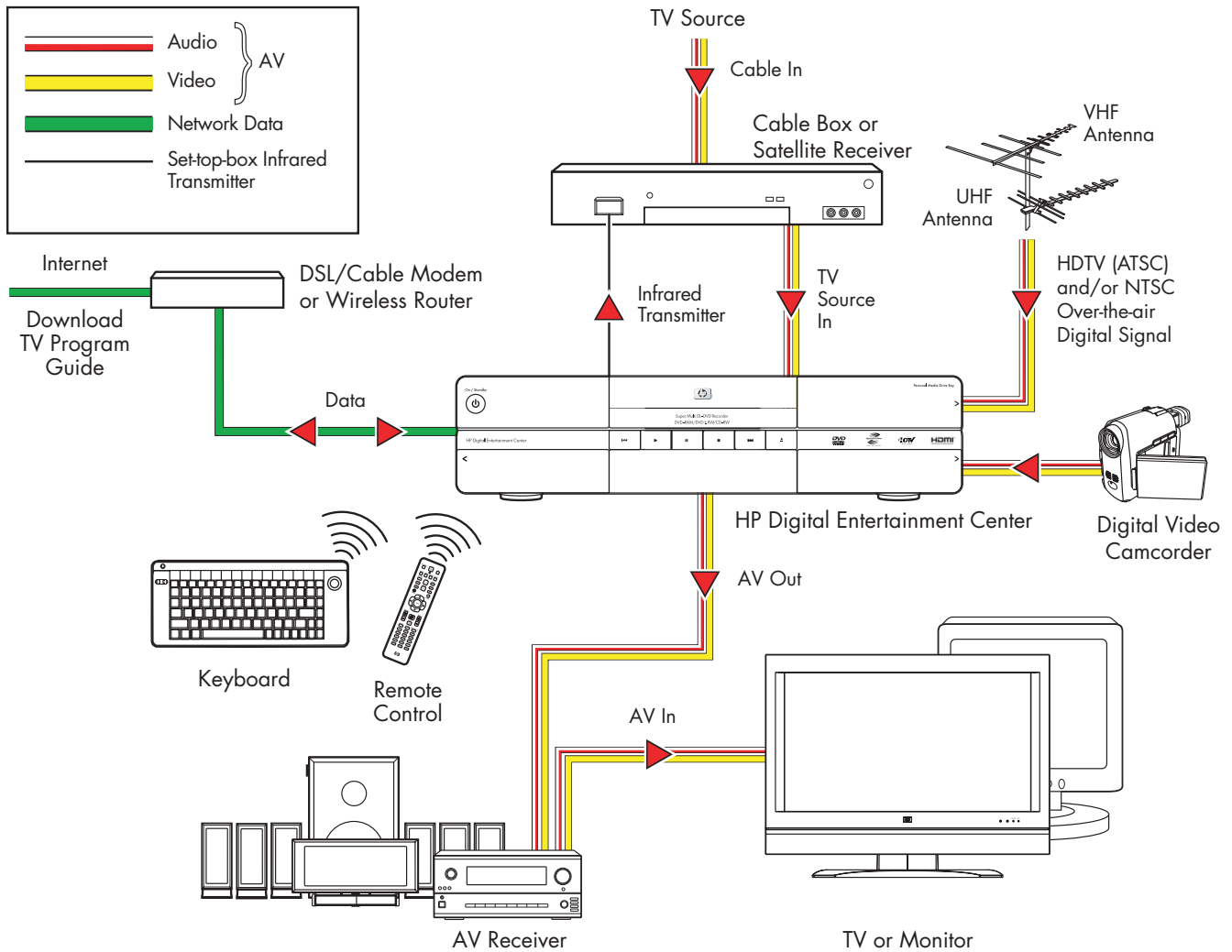

Audio/Video flow

System Diagram

Back Panel

(Configurations may vary.)

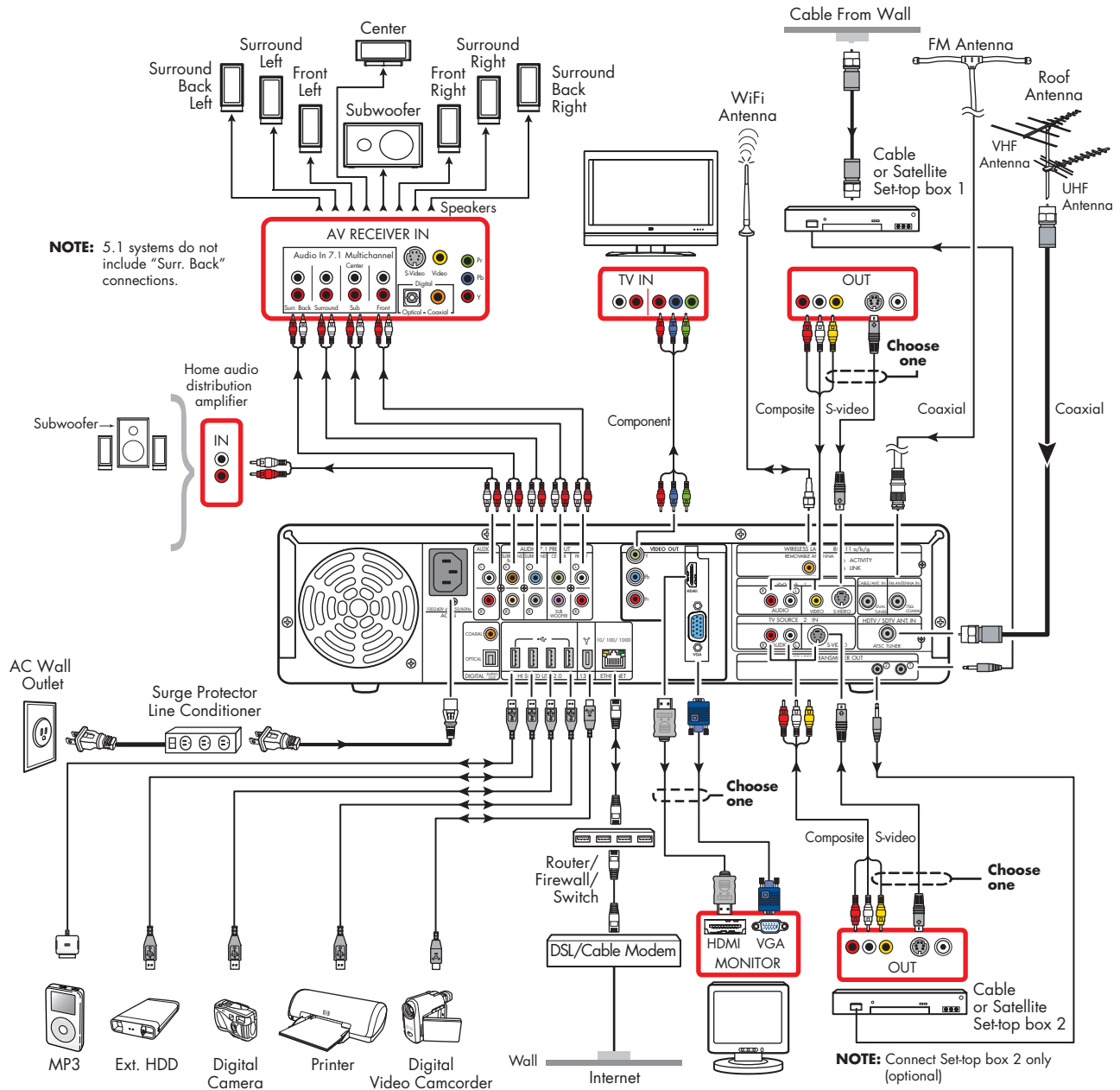

Front Panel

(Configurations may vary.)

The following illustration shows a typical HP Digital Entertainment Center system front panel installation:

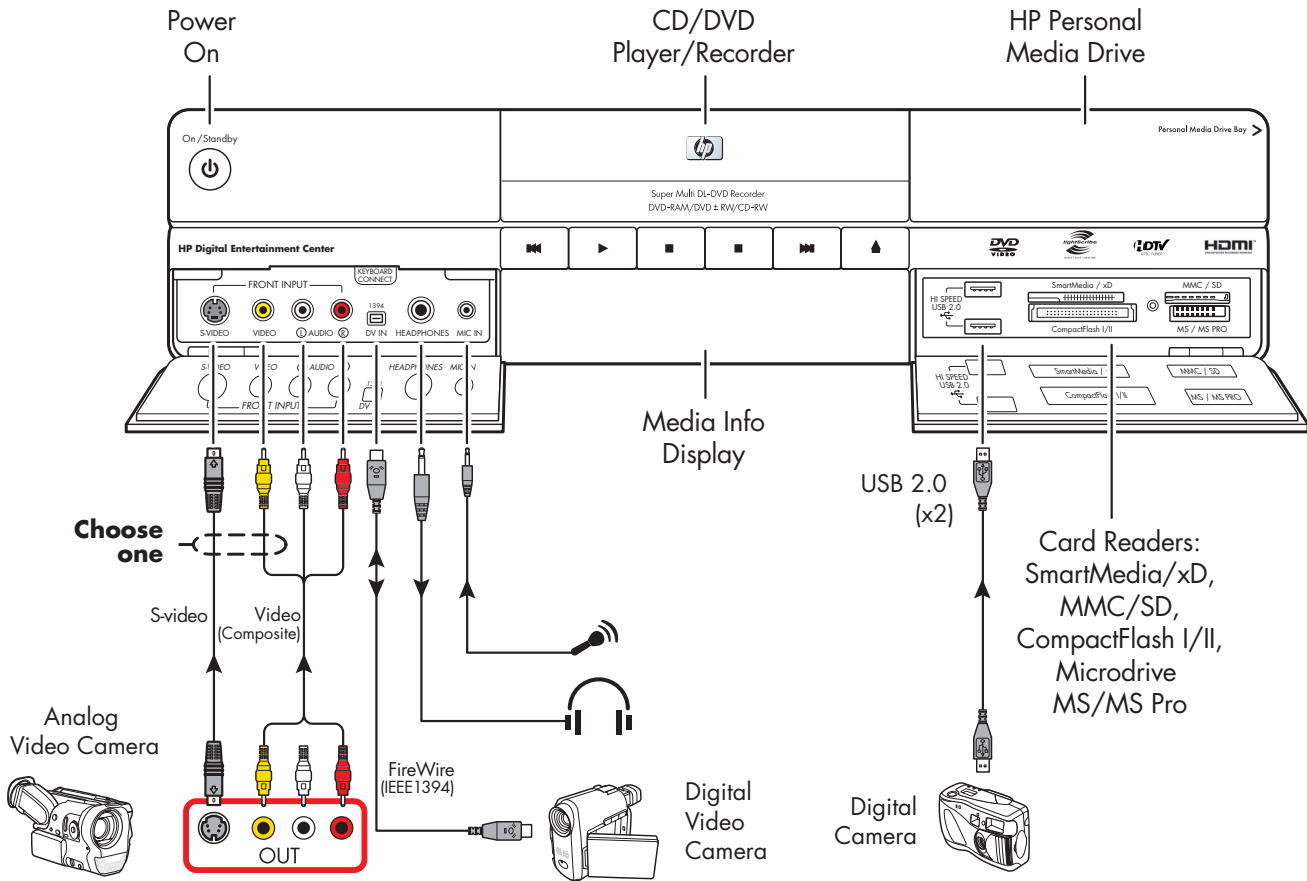

Installation Guidelines

To enhance the performance and extend the life of your HP Digital Entertainment Center:



An open-back is required for adequate cooling when installing your HP Digital Entertainment Center in an AV cabinet.

- Keep your HP Digital Entertainment Center in a well-ventilated area, away from excessive light, heat, or moisture.
- Keep ventilation slots clear of obstructions such as equipment or papers. The HP Digital Entertainment Center automatically turns off if it gets too hot.

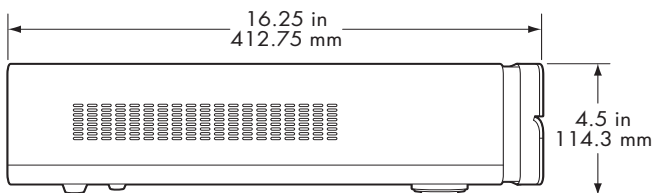
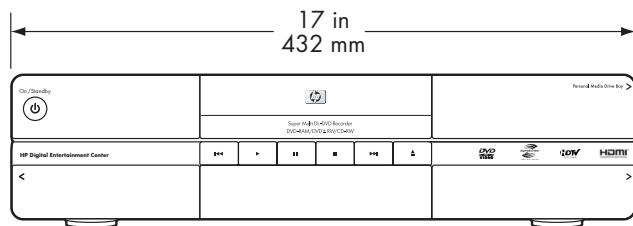

- This product is heavy. Exercise caution when lifting or moving.
- Place your HP Digital Entertainment Center on a stable, supported surface. Do not drop or place it on an unstable surface.
- Put your HP Digital Entertainment Center into Standby when not in use. In Standby, the On/Standby button is lit amber. Preset recordings only start when the HP Digital Entertainment Center is on or in Standby.

- Adjust only those controls that are described in the operating instructions.
- Do not open your HP Digital Entertainment Center cabinet or attempt to service this product yourself. If your HP Digital Entertainment Center is not operating properly or has been dropped or damaged, contact your HP authorized dealer, reseller, or service provider.



Leave slots and openings in the HP Digital Entertainment Center cabinet open for ventilation. These openings must not be blocked or covered. Never push objects of any kind into cabinet slots or other openings.

Choosing an HP Digital Entertainment Center setup location

If you intend to connect your HP Digital Entertainment Center to your TV, a set-top box, or a surround sound system, HP recommends that you choose a clear working area with easy access to the connectors of these devices. If your TV is wall-mounted, make sure that you have access to the rear ports on the TV before attempting to connect it to the HP Digital Entertainment Center.

Placement and Ventilation Requirements

Cabinet Front

IMPORTANT: Use an open cabinet or shelves for best operation of the HP Digital Entertainment Center. Do not cover vents on top, back and sides of the unit.

If you choose to use a cabinet with front doors, you must leave the doors open when the HP Digital Entertainment Center is powered on.



Failure to follow these ventilation requirements could cause the HP Digital Entertainment Center to malfunction.

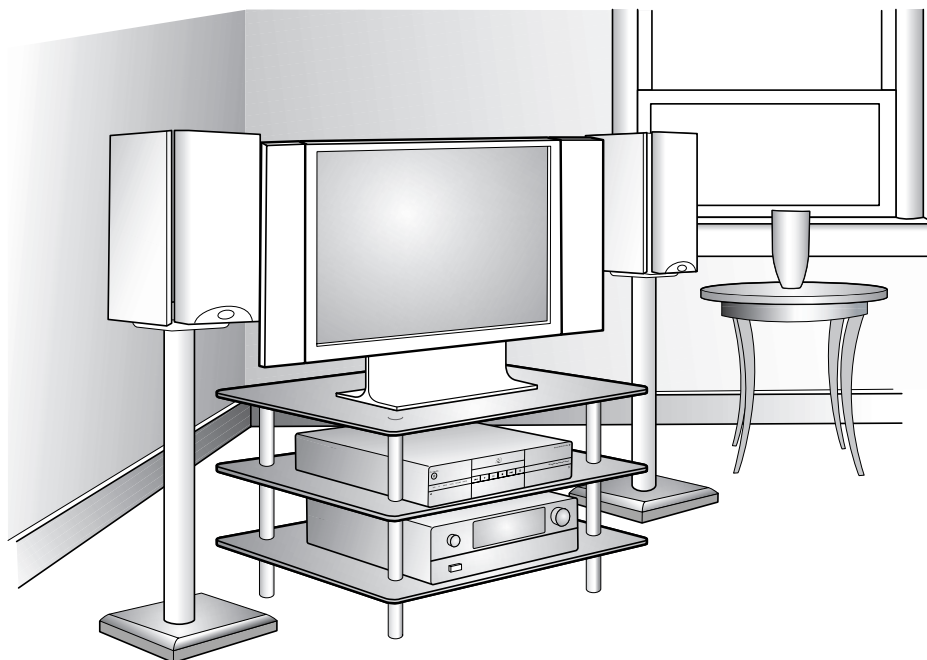

Open cabinet (Actual home setup may vary.)

Cabinet Back

The back of the AV cabinet should be open for best operation.

If the AV cabinet has a back, the back must have a hole behind the HP Digital Entertainment Center, for air circulation, with a minimum open area of 19 inches (48.3 cm) wide by 6.5 inches (16.5 cm) high. See the following illustration.

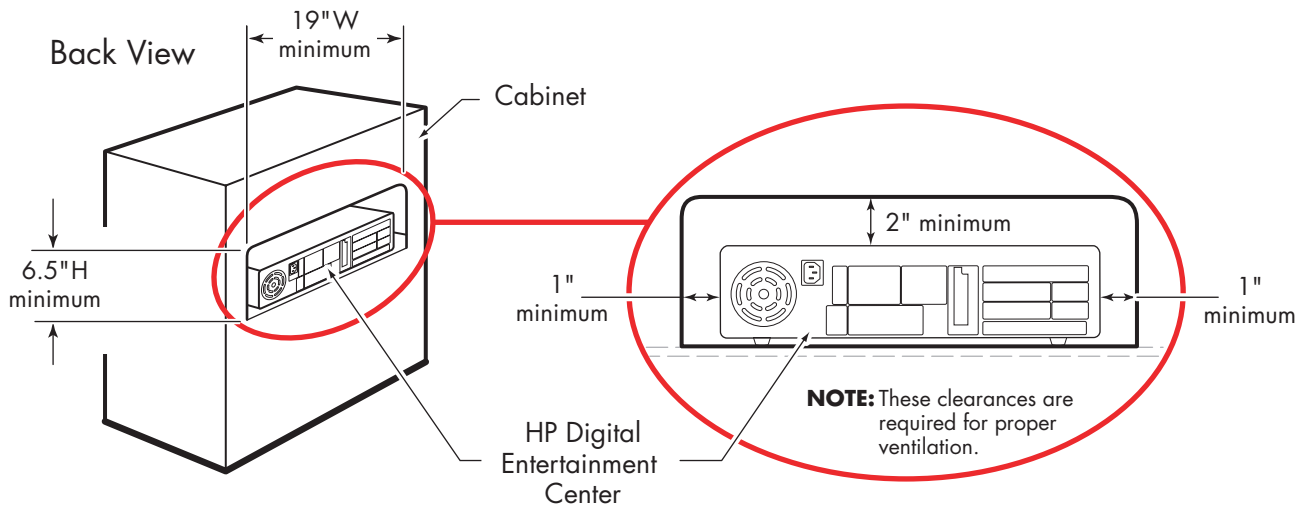

Wall Clearance

The HP Digital Entertainment Center back panel must be at least 4 inches (10.2 cm) from the wall.

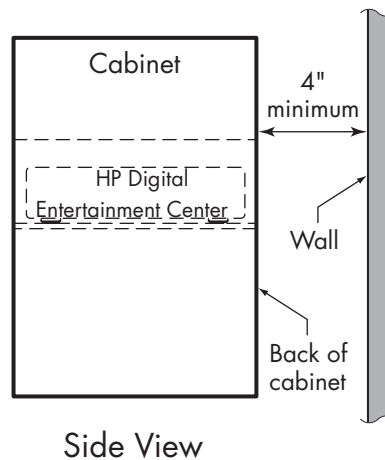

Basic Setup

Follow the steps in the *Start Here* booklet to set up the HP Digital Entertainment Center.

Most of the hardware devices such as the monitor and printer can be connected at the back panel of the HP Digital Entertainment Center.

Some peripheral devices, such as a digital video camera, can be plugged into the connectors on the back panel or the front panel (behind lower doors) of the HP Digital Entertainment Center.

Setting Up the HP Digital Entertainment Center

The basic steps to set up the HP Digital Entertainment Center are in the *Start Here* booklet as follows. Your system may be different. See the referenced sections for detailed information on each step.

Before you begin:

- Read "Safety Information" on page 17.
- Read "Installation Guidelines" on page 24.
- Refer to the *Start Here* booklet as a guide to connect your HP Digital Entertainment Center.



Read the important safety information before you install the HP Digital Entertainment Center. See "Safety Information" on page 17.



Required steps

- 1** Unpack the box contents.
 - a** Take inventory. See "Inventory" on page 29. Identify the items included with your HP Digital Entertainment Center.
 - b** Identify equipment you will need that is not supplied.
 - c** Place the HP Digital Entertainment Center where you can easily reach the back panel.
- 2** Determine how you will connect the HP Digital Entertainment Center to your system.
- 3** Connect the audio cables. See "Typical Audio Connection" on page 38.
 - a** Audio In (optional)
 - b** Audio Out (to TV, AV receiver, speakers)
 - c** Digital Audio Out
- 4** Connect the Video Out to the TV or display. See "Typical Video Out Connections" on page 62.

- 5 Connect the TV Source 1 In and TV Source 2 In cables. See "Typical TV Source Connections" on page 78.
 - a Connect the Cable/Antenna In.
 - b Connect the Source 1 In audio/video cables to cable TV box, digital cable box, or satellite receiver 1.
 - c Connect the Source 2 In audio/video cables to cable TV box, digital cable box, or satellite receiver 2 (select models only).
 - d Connect the Infrared Transmitter 1 to cable TV box, digital cable box, or satellite receiver 1.
 - e Connect the Infrared Transmitter 2 to cable TV box, digital cable box, or satellite receiver 2 (select models only).
 - f Connect the HDTV Antenna In.
 - 6 Connect the FM radio antenna. See "FM Radio Antenna" on page 56.
 - 7 Connect the Internet network cables. See "Typical Network Connections" on page 116.
 - a DSL/cable modem to Internet (Ethernet)
 - b Wireless antenna
 - 8 Pull the tab on the keyboard to activate the batteries. See "Synchronizing the Keyboard" on page 130.
 - 9 Insert the remote control batteries. See "Installing the Remote Control Batteries" on page 16.
 - 10 Place the HP Digital Entertainment Center on a flat, stable surface with the following clearances:
 - Top: 2 inches (5.08 cm)
 - Side: 1 inch (2.54 cm)
 - Back: Open cabinet
 See "Safety Information" on page 17.
 - 11 Turn on all equipment, and then turn on the HP Digital Entertainment Center. See "Starting the HP Digital Entertainment Center for the First Time" on page 128.
 - 12 Complete the initial startup and registration. See "Windows Welcome" on page 131.
 - a Follow the onscreen instructions.
 - b Set up Media Center.
 - 13 **Optional step (Recommended after basic setup)**
Connect any additional rear panel devices.
 - a FireWire (IEEE 1394) device or digital video camera. See "Peripheral Connection Overview" on page 114.
 - b USB devices, such as printers or scanners (up to 4). See "Peripheral Connection Overview" on page 114.
 - 14 **Optional step (Recommended after basic setup)**
Connect front panel devices.
 - a FireWire (IEEE 1394) device or digital video camera. See "Connecting Video Equipment" on page 101.
 - b USB devices, such as printers or scanners (up to 2). See "Peripheral Connection Overview" on page 114.
 - c VCR or analog video camera. See "Connecting Video Equipment" on page 101.
 - d Insert the removable hard disk drive (optional). See "Connecting an HP Personal Media Drive" on page 123.
- Begin using your system. See the *HP Digital Entertainment Center Software Guide*.



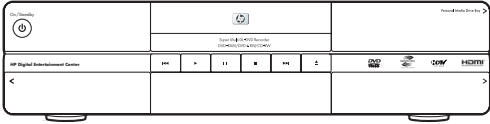
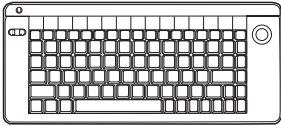
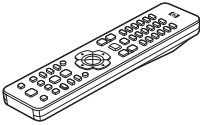
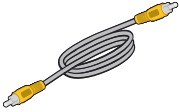
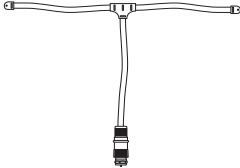

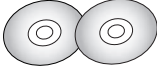
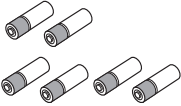
Inventory

The following items are supplied with the HP Digital Entertainment Center:

Name	Picture	Description
HP Digital Entertainment Center unit		See "Functional Overview" on page 3.
Keyboard		See "Keyboard" on page 10.
Remote control		See "Remote Control" on page 14.
Cables		See "Cables Included" on page 30.
FM antenna		Antenna for FM radio, 75-ohm coaxial. See "FM Radio Antenna" on page 56.
Wi-Fi antenna		Antenna for Wireless LAN 802.11 a/b/g, removable. See "Connecting the Wireless Network Antenna" on page 117.
Documentation		Printed documentation is included.
DVD-R discs (2)		Blank DVD-R media discs that can be used to create your System Recovery Discs.
Batteries: AA (6)		2 for remote (in package), 4 for keyboard (inside keyboard).

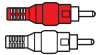
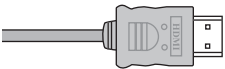
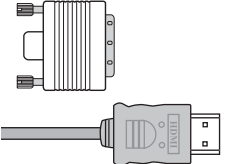
Cables Included













Your HP Digital Entertainment Center comes with the following cables.

Cable	Name	Description
	Stereo	RCA, red and white ends. Used for Audio Out.
	HDMI	High Definition Multimedia Interface digital video out and audio out. Connect to HDMI input of the HDTV- capable TV or monitor.
	DVI-D to HDMI Adapter	Connect to DVI input of the HDTV- capable TV or monitor to the HDMI Out on the Digital Entertainment Center.
	Coaxial digital audio	S/PDIF. Used for Digital Audio Out.
	Infrared Transmitter (2 with dual-tuner option)	IR Blaster cable. Used for set-top boxes.
	AC Power	Black 125V [~] 10A.

Additional cables are sold separately. See "Optional Cables Not Included" on page 31 for additional cables that you may need.

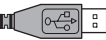
Optional Cables Not Included

You might need the following extra cables (these items are sold separately).

Cable	Name	Max quantity	Description
	Stereo and Video (Composite)	4	RCA: Red, white, yellow ends. Used for TV Source In connector.
	Stereo	8	RCA: Red and white ends. Used for Audio In/Out connectors.
	Component video	1	RCA: Red, blue, and green ends. Used for progressive scan component video.
	S-video	4	Y/C, 4-pin. Plug cable into an S-video connector such as S-video Video Out or TV Source In connector.
	Video (Composite)	4	RCA: Yellow end. Plug cable into an RCA connector such as composite Video Out or TV Source In connector.
	S-video to composite video adapter	1	Used with TV source input 2 composite video input.
	VGA	1	15-pin, D-sub Analog. Used for monitor or HDTV capable TV.
	Optical digital audio	1	S/PDIF. Used for Digital Audio Out.
	FireWire (IEEE 1394) digital video in/out	1 1	FireWire (IEEE 1394) 4-pin to 6-pin (back). FireWire IEEE 1394 4-pin to 4-pin (front).
	USB	6	USB 2.0. Used for peripheral device connectors.
	Ethernet RJ-45	1	Ethernet 10/100/1000. Used for broadband Internet connection.
	Coaxial	Extra lengths	Used for TV source input from cable set-top boxes or antennas.
	Coaxial Splitter (dual-tuner option)	1	Used with coaxial cable for VHF and UHF antenna combinations.

Additional equipment

You must have the following items to set up and properly operate your HP Digital Entertainment Center and system (these items are sold separately):

- Audio system equipment such as:
 - AV receiver with speakers
 - Powered speakers
 - TV speakers
 - Monitor speakers
- Video equipment such as:
 - Monitor
 - TV
 - Video projector
 - Video output from cable/satellite box or antenna
 - UHF/VHF antenna for HDTV ATSC

- Broadband Internet equipment such as:
 - Cable/DSL modem (working connection required for Media Center features, such as downloading the Television Program Guide)
 - Wireless LAN 802.11 a/b/g network
- Clean AC power (surge protector/line conditioner recommended)

Additional equipment and cables are sold separately.

You may also need the following items (sold separately; available at electronics stores) to fully set up your HP Digital Entertainment Center, depending on your system audio and video requirements:

- Audio/Video/Network cables: See "Optional Cables Not Included" on page 31.
- Audio Y adapter(s), mini-plug to 2 RCA-plugs (for powered speakers).

Connecting cables

Observe the following guidelines:

- Turn off power to all other equipment before connecting cables.
- Connect all the cables of your HP Digital Entertainment Center and then plug in the power cable last.
- Connect cables firmly to avoid hum and noise.
- Match the color codes, for instance: yellow — video, white — left, red — right.

Connecting Audio

The HP Digital Entertainment Center supports many different audio options, sound connections, and speaker configurations.

This chapter describes the most typical, and some advanced, audio setup options for connecting Audio Out and Audio In. To connect TV Source In audio and video, see "Connecting TV Source In" on page 71.

Your system may have different components. Speakers, AV receivers, and other equipment are sold separately. Refer to the product documentation for these products.

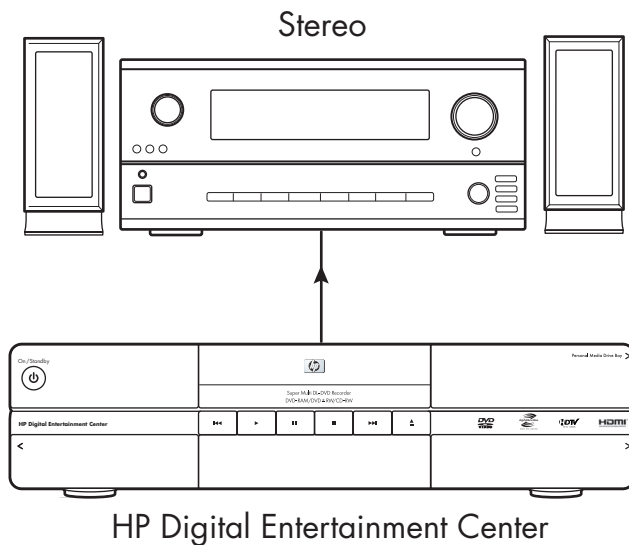

Chapter Contents:

"Audio Overview" on page 34
"Typical Audio Connection" on page 38
"TV Audio Connection" on page 39
"AV Receiver Audio Connection" on page 40
"Powered Speaker Audio Connection" on page 48
"Audio Out Connections" on page 55
"FM Radio Antenna" on page 56









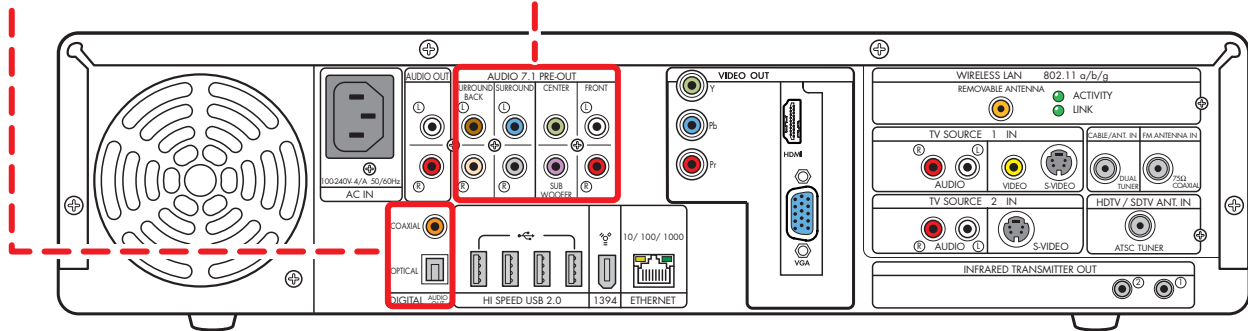



Audio Overview

Audio Output Connectors

Digital Audio Out

Audio Out



Connector	Name	Color	Description	Cable
	Surround Back	Brown: Left Beige: Right	Rear speakers in a multichannel audio eight speaker system (7.1).	
	Surround	Blue: Left Gray: Right	Side speakers in a multichannel audio six or eight speaker system (4.1, 5.1, 6.1, 7.1).	
	Center Subwoofer	Green: Center Purple: Subwoofer	Center speaker and subwoofer in a multichannel audio system (5.1, 6.1, 7.1).	
	Front	White: Left Red: Right	Stereo speakers or front speakers in a multichannel audio system (2.0, 2.1, 4.1, 5.1, 6.1, 7.1).	
	Coaxial Digital Audio Out	Orange	Coaxial S/PDIF See "Configuring Audio Output" on page 138.	
	Optical Digital Audio Out	Gray	Optical S/PDIF See "Configuring Audio Output" on page 138.	

Sound Connector Jacks

The audio connectors are RCA-type jacks that connect from the back of your HP Digital Entertainment Center to a TV, powered speakers, or an AV receiver.

The HP Digital Entertainment Center has two Digital Audio Out connections (S/PDIF) that are coaxial and optical. Use analog Audio 7.1 Pre-out or Digital Audio Out connectors, but not both. Use only one Digital Audio Out connector at a time.

The HP Digital Entertainment Center does not have Digital Audio In connections.



If your audio equipment has multiple input and output connections, then it has front panel input and output switches.

You must select the correct input and output from the audio equipment front panel or remote control to hear sound and see video.

Speaker Types

A stereo speaker set is a left-right, two-channel speaker system (sold separately).

A multichannel audio speaker system has a subwoofer, left-right front, and left-right surround channels. The system may also include a left-right surround back channel and a center speaker. Surround back speakers are included in more advanced 7.1 systems. A subwoofer provides enhanced bass sounds.

The “.1” indicates a subwoofer. For example, 7.1 channels refer to an eight-speaker mode and uses two front speakers (left-right), two side speakers (left-right), two rear speakers (left-right), a center speaker, and a subwoofer.

See “Speaker Configurations” on page 36 for more information on speaker arrangements.

Audio amplifiers

The HP Digital Entertainment Center does not supply an amplified audio signal. You can connect the HP Digital Entertainment Center to:

- Passive speakers connected through a home audio system. A home audio system does not require active speakers because the receiver provides amplification.
- Active (powered) speakers directly. An active speaker system must have its own power cord.

Speaker Configurations

You can set up your HP Digital Entertainment Center for the following supported audio configurations:

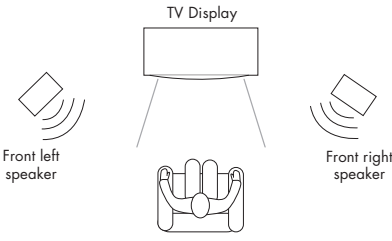
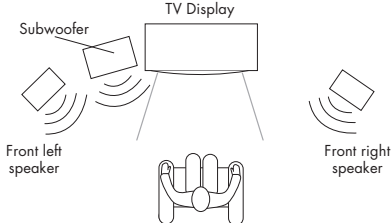
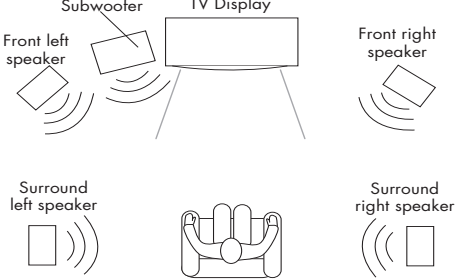
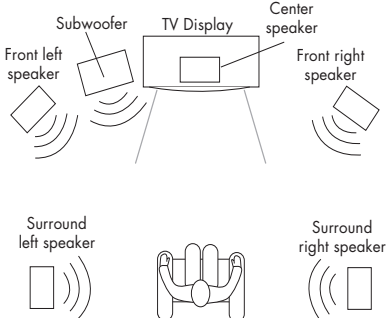
Speaker system	Home audio system description	Recommended arrangement	See:
2 (stereo)	Two speakers: Left speaker, right speaker		<p>"2.0 Home Stereo Installation" on page 41</p> <p>Or</p> <p>"2.1 Powered Speakers" on page 49</p>
2.1	Two speakers: Left speaker, right speaker One subwoofer		<p>"2.1 Home Stereo Installation" on page 42</p> <p>Or</p> <p>"2.1 Powered Speakers" on page 49</p>
4.1	Two front speakers: Left speaker, right speaker Two side speakers: Surround left speaker, surround right speaker One subwoofer		<p>"4.1 Home Theater Audio" on page 43</p> <p>Or</p> <p>"4.1 Powered Speakers" on page 50</p>
5.1	Two front speakers: Left speaker, right speaker Two side speakers: Surround left speaker, surround right speaker One center speaker One subwoofer		<p>"5.1 Home Theater Audio" on page 44</p> <p>Or</p> <p>"5.1 Powered Speakers" on page 51</p>

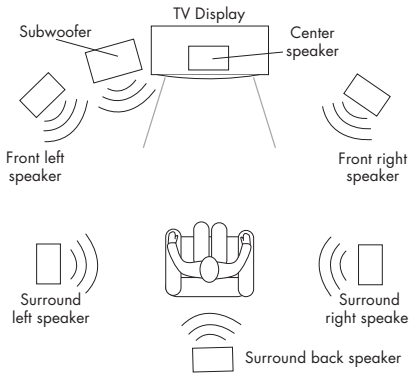
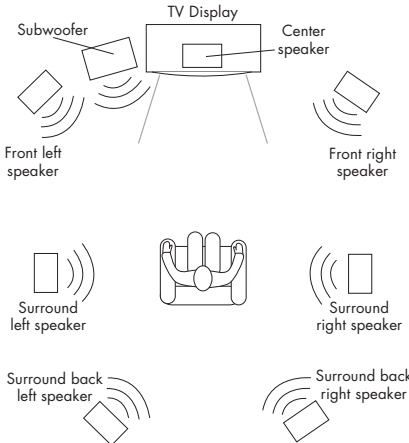
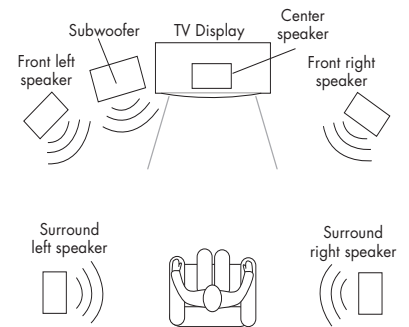
Speaker system	Home audio system description	Recommended arrangement	See:
6.1	<p>Two front speakers: Left speaker, right speaker</p> <p>Two side speakers: Surround left speaker, surround right speaker</p> <p>One rear surround back speaker</p> <p>One center speaker</p> <p>One subwoofer</p>		<p>If your 6.1 AV receiver has only 5.1 (6) inputs, see the following:</p> <p>“5.1 Home Theater Audio” on page 44</p> <p>Or</p> <p>“5.1 Powered Speakers” on page 51</p>
7.1	<p>Two front speakers: Left speaker, right speaker</p> <p>Two side speakers: Surround left speaker, surround right speaker</p> <p>Two rear speakers: Surround back left speaker, surround back right speaker</p> <p>One center speaker</p> <p>One subwoofer</p>		<p>“7.1 Home Theater Audio” on page 45</p> <p>Or</p> <p>“7.1 Powered Speakers” on page 52</p> <p>If your 7.1 AV receiver has only five inputs, see “5.1 Home Theater Audio” on page 44</p>
Digital audio 5.1	<p>Digital speakers or digital input connector on the audio system</p>		<p>“Digital Home Theater Audio” on page 46</p> <p>Or</p> <p>“Digital Powered Speakers” on page 53</p>

Typical Audio Connection

Select the configuration that most closely matches your home system.

You can set up your HP Digital Entertainment Center for the following supported audio configurations:

Audio system	Description	See:
TV	TV, monitor or display direct audio connection with two speakers	"TV Audio Connection" on page 39
AV receiver	Home stereo or home theater audio system with AV receiver and passive speakers	"AV Receiver Audio Connection" on page 40
Powered speakers	Audio system with active speakers	"Powered Speaker Audio Connection" on page 48
FM	FM Tuner In	"FM Radio Antenna" on page 56
Headphones	Speakers are muted on headphone connection	"Connecting Headphones" on page 135

Then see:
"Audio Out Connections" on page 55
"Connecting Video Out" on page 57
"Configuring Audio" on page 135

TV Audio Connection

You can connect your TV, monitor, or display audio directly to your HP Digital Entertainment Center for two-speaker sound.

If your TV has multiple inputs, you can use your TV as a switch for audio and video.

Connecting TV Audio

To connect a TV, monitor, or display audio directly:

- Connect an RCA stereo cable (White: Left; Red: Right) from the HP Digital Entertainment Center back panel Audio Out connector to a TV Audio In connector.

Refer to the *Start Here* booklet that came with the HP Digital Entertainment Center.

For additional information on connecting the speakers, refer to the documentation that came with your speakers and AV receiver.

The following diagram shows a basic TV audio installation:

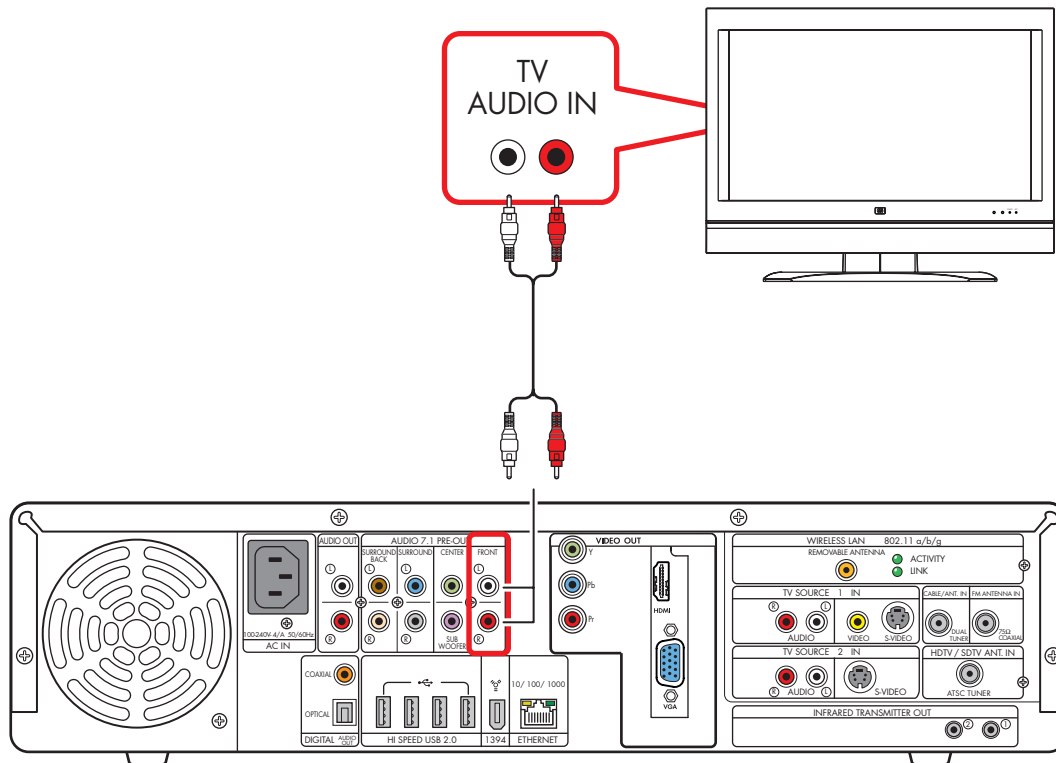

Basic TV audio setup (2.0)

AV Receiver Audio Connection

You can connect your HP Digital Entertainment Center to your home stereo or home theater multichannel AV receivers or audio amplifiers using your existing speakers.



You can also connect video through your AV receiver or to your TV directly.

Select the configuration that most closely matches your home system. See:

"2.0 Home Stereo Installation" on page 41

"2.1 Home Stereo Installation" on page 42

"4.1 Home Theater Audio" on page 43

"5.1 Home Theater Audio" on page 44

"7.1 Home Theater Audio" on page 45

You can also use a digital connection.

"Digital Home Theater Audio" on page 46

AV Receiver Equipment Overview

You can connect audio and video from the HP Digital Entertainment Center, through an AV receiver, to the TV input.

Use this method to connect AV receivers or audio-only home receiver/amplifiers that have standard RCA-type input connectors. You may have to select a front panel button on your AV receiver to switch audio inputs to hear sound.

Use the 2.1 configuration for multichannel AV receivers that have only left and right audio inputs.

Connecting a home stereo to an HP Digital Entertainment Center typically requires audio cables that are long enough to connect from the HP Digital Entertainment Center to the stereo or AV receiver. Additional cables are sold separately.

2.0 Home Stereo Installation

The following diagram shows a typical two-channel (2.0) speaker installation that uses passive stereo speakers connected through a home stereo standard left and right input.

This is only a suggested configuration. Your system may be different.

AV receiver/amplifier audio input connectors may be labeled CD, DVD, or DVD In.

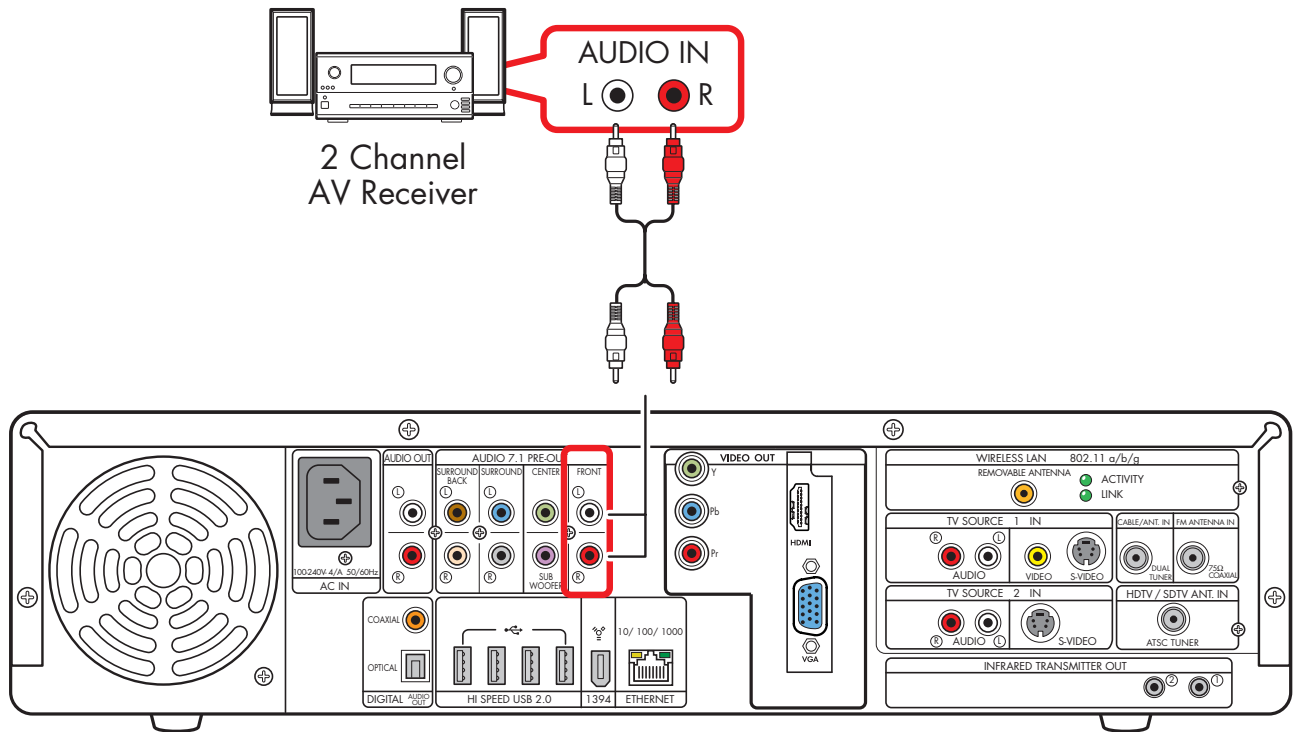

2.0 audio system connection

2.1 Home Stereo Installation

The following diagram shows a typical two-channel (2.1) speaker installation that uses passive stereo speakers connected through a home stereo standard left and right input.

This is only a suggested configuration. Your system may be different. Use this configuration for multichannel AV receivers that only left and right audio inputs.

AV receiver/amplifier audio input connectors may be labeled CD, DVD, or DVD In.



Some AV receivers generate the subwoofer output without a subwoofer input; in this case, you do not need to connect the subwoofer output from the HP Digital Entertainment Center. Refer to your AV receiver product documentation.

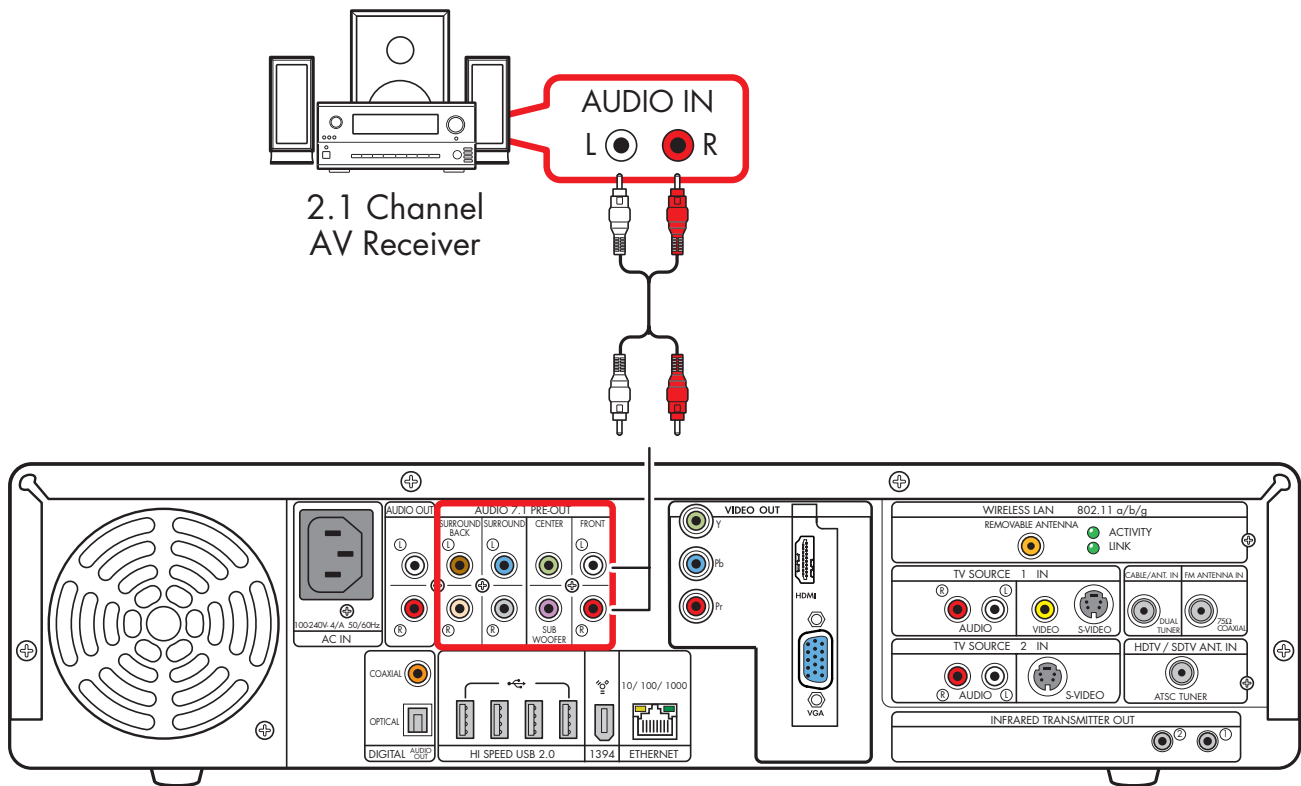

2.1 multichannel audio system connection

4.1 Home Theater Audio

The following diagram shows a typical advanced home theater audio four-channel 4/4.1 speaker installation that requires multichannel inputs on a receiver/amplifier.

This is only a suggested configuration. Your system may be different.

AV receiver/amplifier audio input connectors may be labeled Surround, 4.1 or 4 Channel inputs, CD, DVD, or DVD In.



Some AV receivers generate the subwoofer output without a subwoofer input; in this case, you do not need to connect the subwoofer output from the HP Digital Entertainment Center. Refer to your AV receiver product documentation.

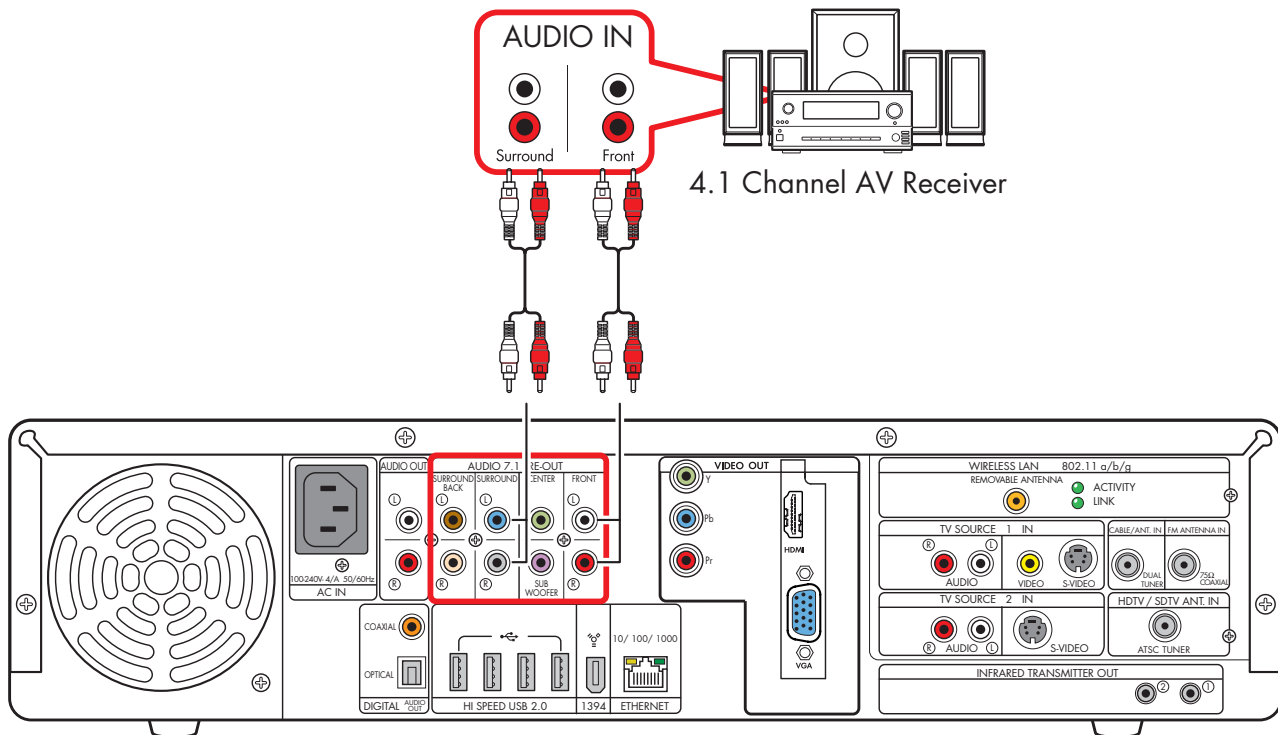

4.1 multichannel audio system connection

5.1 Home Theater Audio

The following diagram shows a typical advanced home theater audio six-channel (5.1) speaker installation that requires multichannel inputs on an AV receiver.

This is only a suggested configuration. Your system may be different. Use this configuration for 6.1 and 7.1 AV receivers that upmix the rear speaker(s). Use the 2.1 configuration for 5.1 AV receivers that have only left and right inputs. Refer to your AV receiver product documentation.

AV receiver audio input connectors may be labeled Surround, 5.1 or 6 Channel Inputs, DVD, Ext. In, or Multichannel Inputs.



Both Media Center speaker settings and DVD audio settings must be changed for proper audio setup. Go to "Configuring Audio Output" on page 138 and note your speaker configuration choice for later software setup steps.

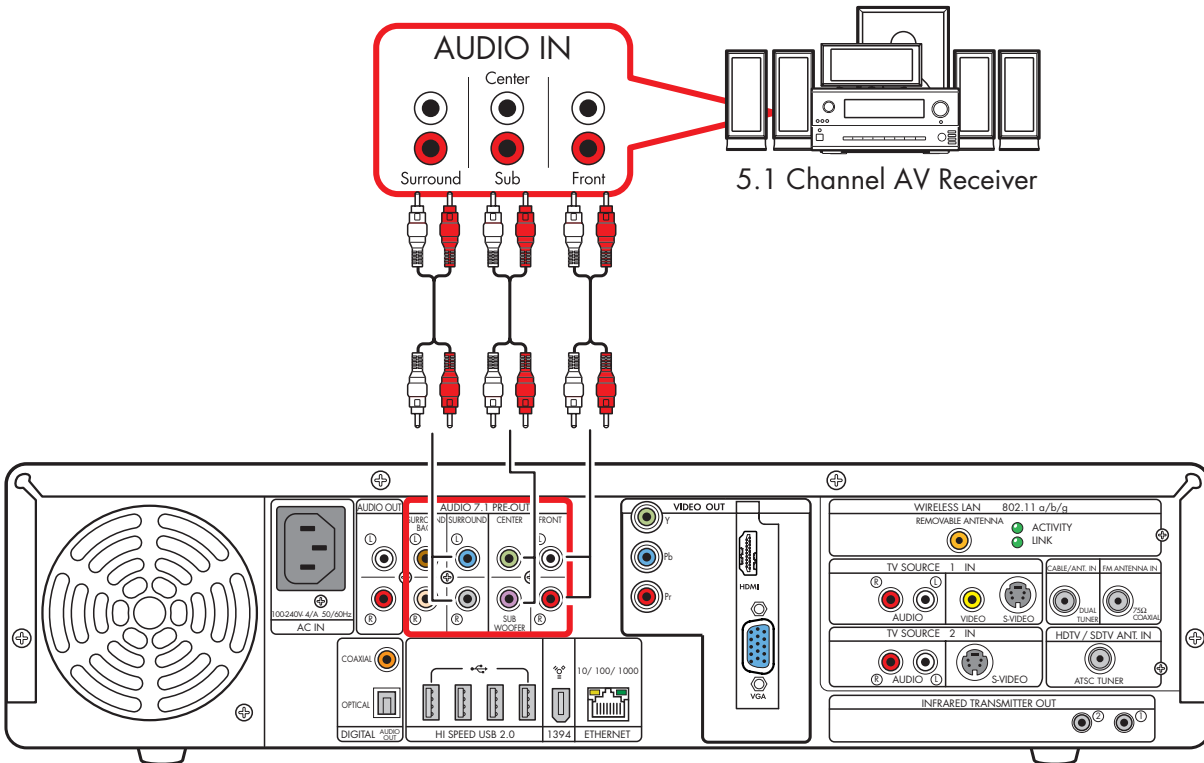

5.1 multichannel audio system connection

7.1 Home Theater Audio

The following diagram shows a typical advanced home theater audio eight-channel (7.1) speaker installation that requires multichannel inputs on an AV receiver.

This is only a suggested configuration. Your system may be different. If your AV receiver supports 7.1 and has only 5.1 inputs, see "5.1 Home Theater Audio" on page 44.

AV receiver audio input connectors may be labeled Surround, 7.1 or 8 Channel inputs, DVD, Ext. In, or Multichannel Inputs.



Some AV receivers can generate (upmix) the 7.1 audio with 5.1 channels. Refer to your AV receiver product documentation.



Both Media Center speaker settings and DVD audio settings must be changed for proper audio setup. Go to "Configuring Audio Output" on page 138 and note your speaker configuration choice for later software setup steps.

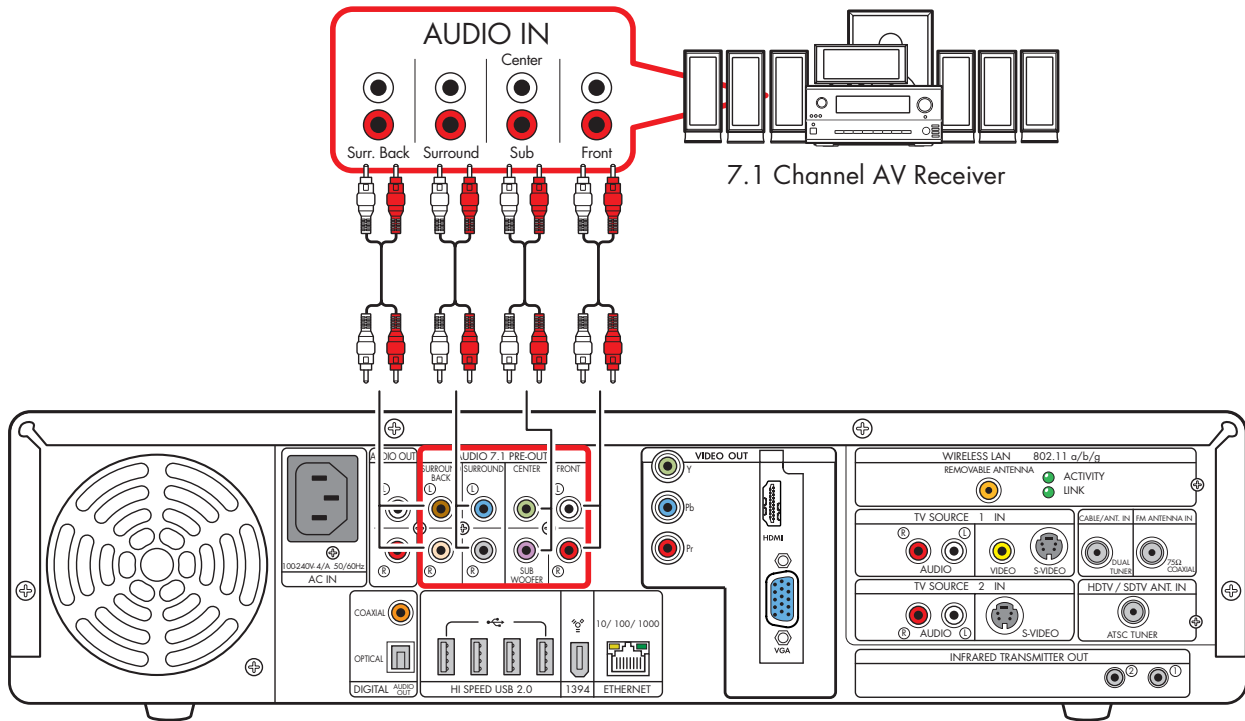

7.1 multichannel audio system connection

Digital Home Theater Audio

The HP Digital Entertainment Center supports digital audio output.

- For TV and music: two-channel stereo. (Your AV receiver may separate the audio signal into multiple channels.)
- For DVD playback: the multiple channel Dolby Digital 5.1 or DTS Digital encoded audio signal passes to your AV receiver for decoding. Refer to your AV receiver product documentation.

You can connect either the coaxial or the optical digital audio cable, depending on your system. If you have both cables, connect only one cable. Do not connect analog multichannel speaker outputs if you connect the digital output.

- Insert optical cords straight in until they click into place.
- Do not bend or tie optical cords.

To connect digital audio from your HP Digital Entertainment Center to an AV receiver:

- 1 Connect the Digital Audio Out connector on the back panel of your HP Digital Entertainment Center to the Digital Input (S/PDIF) on your AV receiver or digital audio system.
- 2 Select the AV receiver input.
- 3 Use the AV receiver to adjust the volume.



Some AV receivers can generate (upmix) the 7.1 audio with 5.1 channels. Refer to your AV receiver product documentation.

The following diagram shows a typical advanced home theater audio six-channel 5.1 speaker installation that requires a digital input on an AV receiver. This is only a suggested configuration. Your system may be different, such as having more speakers.



Both Media Center speaker settings and DVD audio settings must be changed for proper audio setup. Go to "Configuring Audio Output" on page 138 and note your speaker configuration choice for later software setup steps.

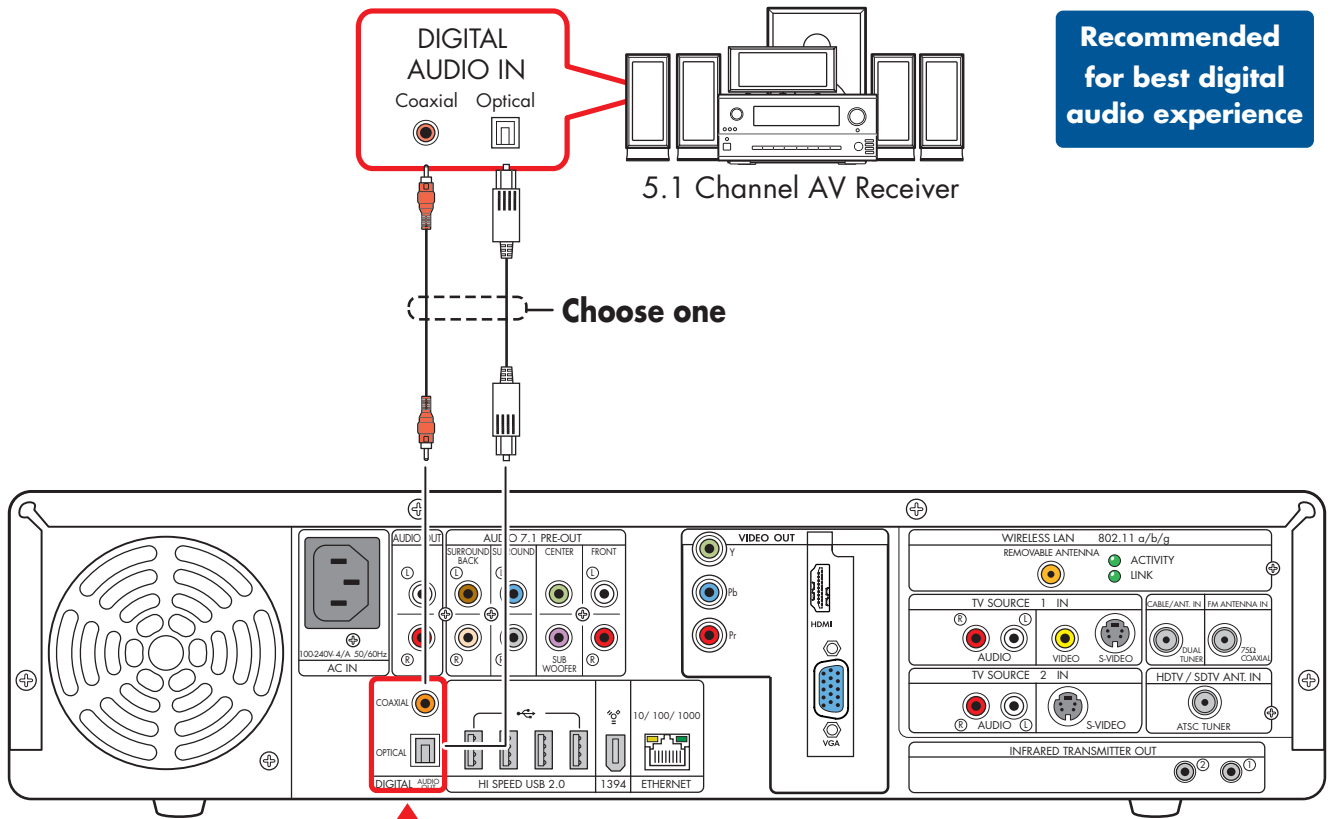

Digital 5.1 multichannel audio system connection

Powered Speaker Audio Connection

You can connect active (powered) speakers directly to your HP Digital Entertainment Center. An active speaker system must have its own power cord.

You may need Y adapter cables (sold separately).

Select the configuration that most closely matches your home system. See:

"2.1 Powered Speakers" on page 49

"4.1 Powered Speakers" on page 50

"5.1 Powered Speakers" on page 51

"7.1 Powered Speakers" on page 52

You can also use a digital connection.
"Digital Powered Speakers" on page 53

Y adapter cables

The HP Digital Entertainment Center has RCA-type output connectors. You may need to connect Y adapter cables between your HP Digital Entertainment Center analog audio output and your powered speaker inputs. You can also use them for audio inputs depending on your equipment.

Use Y adapter cables with one female 1/8 inch (3.5 mm) stereo mini-jack on one end and two male RCA connectors on the other end. These cables are sold separately.

The number of Y adapter cables you need to connect to your home stereo system depends on the number of speakers you install.

Select the cable that most closely matches your home system:

2.1 speaker system: 1 Y adapter cable

4.1 speaker system: 2 Y adapter cables

5.1 speaker system: 3 Y adapter cables

7.1 speaker system: 4 Y adapter cables



Y adapter cables and extension cables are sold separately.

2.1 Powered Speakers

To connect simple left/right stereo (2.0) active speakers:

Or

To connect two speakers and a subwoofer for 2.1 speaker output:

- 1 Connect the RCA connector end of the Y adapter cable (sold separately) to the Front Right and Front Left Audio Out connectors on the back of your HP Digital Entertainment Center.
- 2 Connect the female 1/8 inch (3.5 mm) mini-jack end of the Y adapter cable to the Audio Line In cable of the speaker amplifier.
- 3 Plug in the speaker system power. Refer to the speaker documentation.
- 4 Turn on the speaker system.

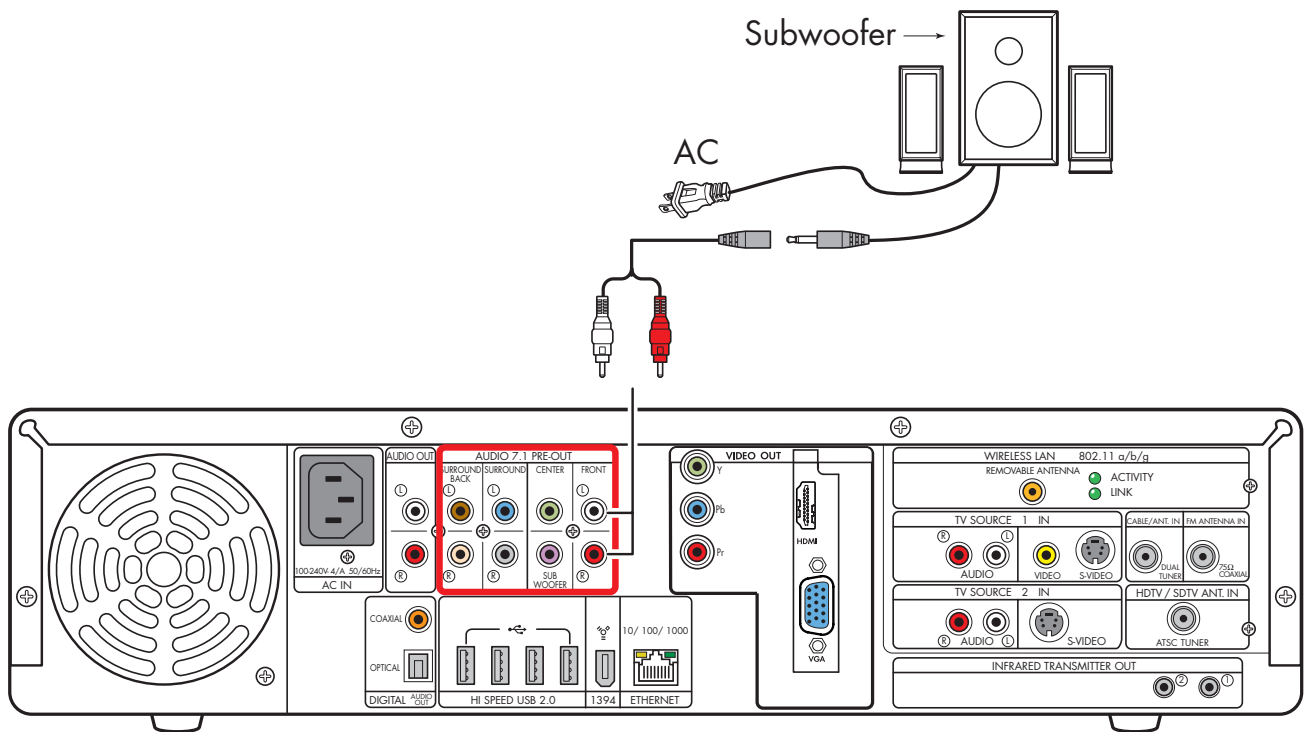

2.1 powered speaker installation

4.1 Powered Speakers

To connect two front speakers, two surround speakers, and a subwoofer for four-channel (4.1 speaker) output:

- 1 Connect the RCA connector end of the Y adapter cables (sold separately) to the Audio Out connectors Front Right, Front Left, Surround Right, and Surround Left on the back of your HP Digital Entertainment Center.
- 2 Connect the female 1/8 inch (3.5 mm) mini-jack end of the Y adapters to the Audio Line In cables of the speaker amplifier.
- 3 Plug in the speaker system power. Refer to the speaker documentation.
- 4 Turn on the speaker system.

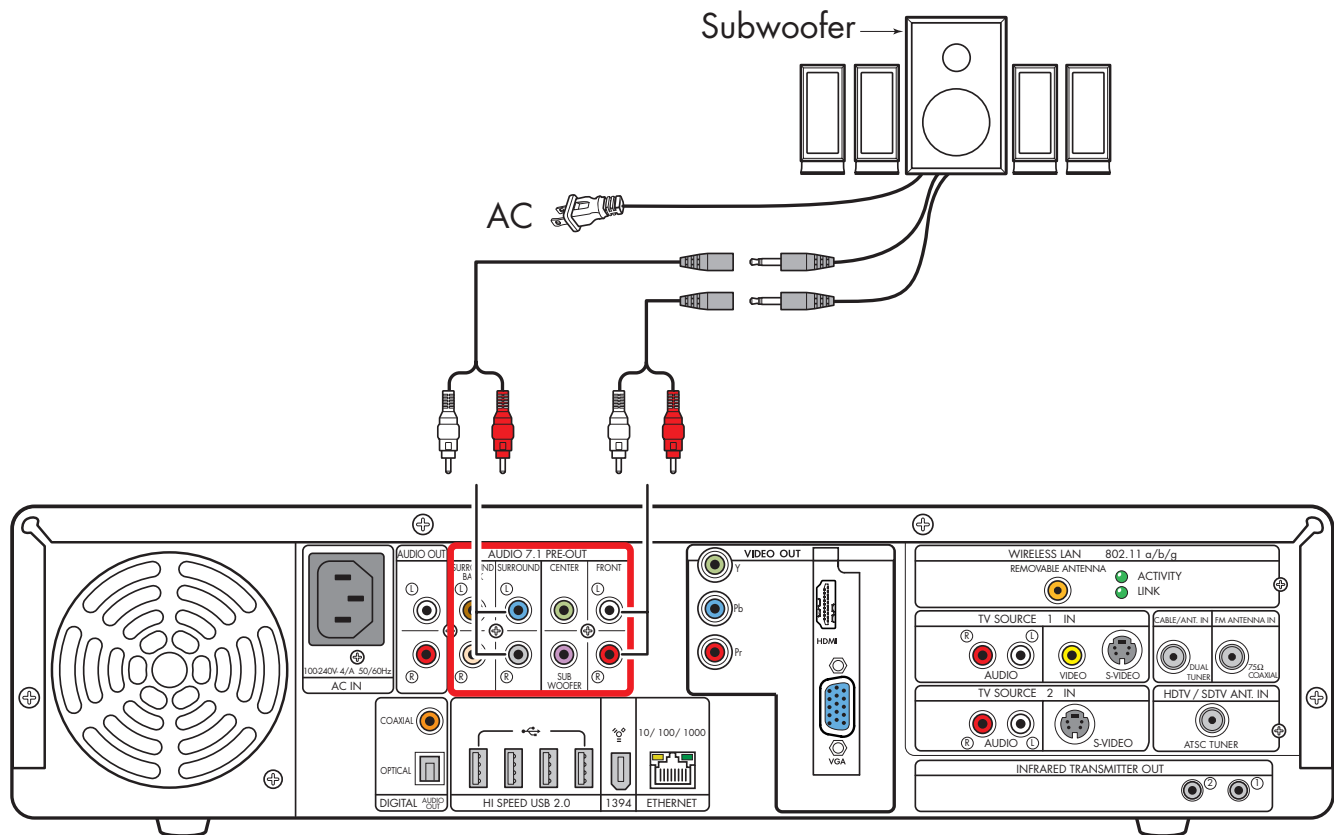

4.1 powered speaker installation

5.1 Powered Speakers

To connect two front speakers, two surround speakers, a center speaker, and a subwoofer for six-channel (5.1 speaker) output:

- 1 Connect the RCA connector end of the Y adapter cables (sold separately) to the Audio Out connectors Front Right, Front Left, Surround Right, Surround Left, and Center on the back of your HP Digital Entertainment Center.
- 2 Connect the female 1/8 inch (3.5 mm) mini-jack end of the Y adapters to the Audio Line In cables of the speaker amplifier.
- 3 Plug in the speaker system power. Refer to the speaker documentation.
- 4 Turn on the speaker system.

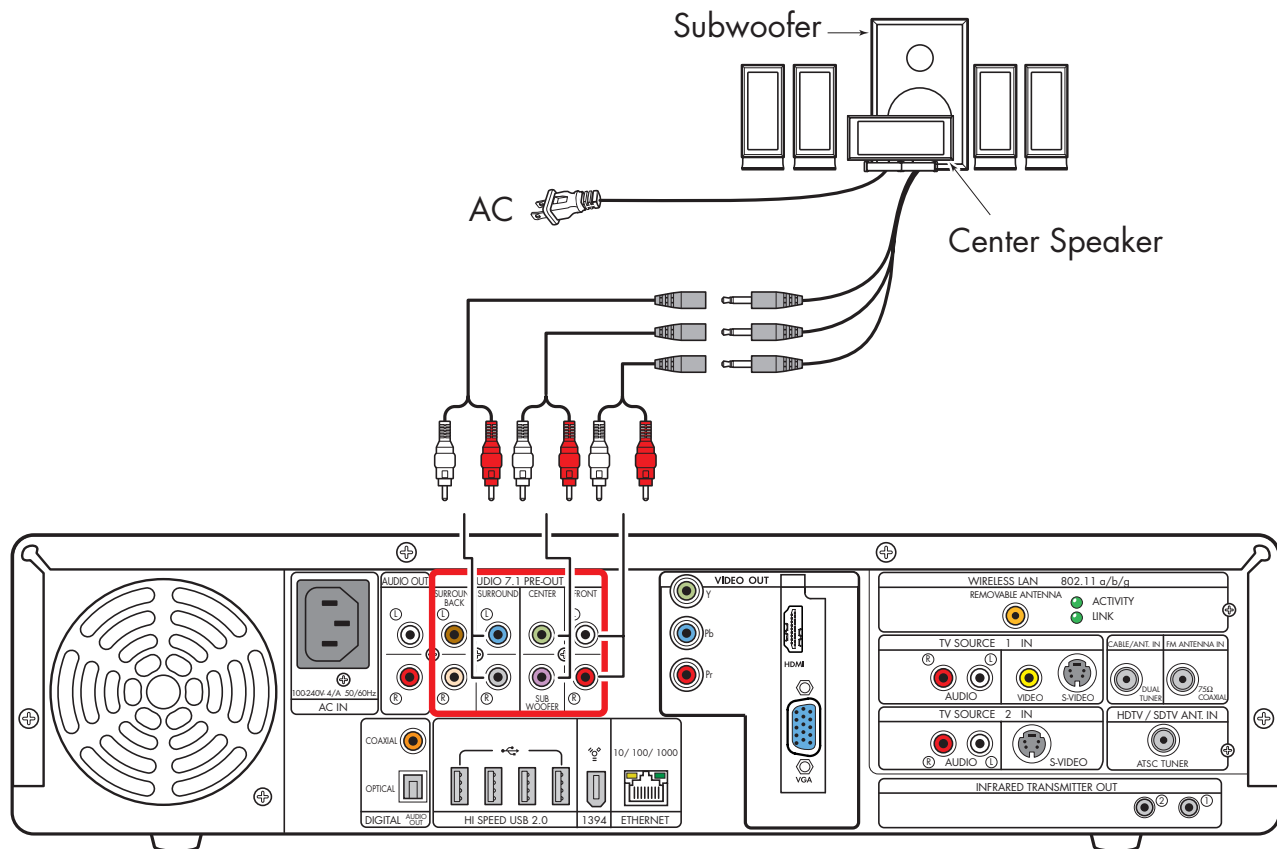

Typical 5.1 powered speaker installation

7.1 Powered Speakers

You can install a 7.1 audio system to your HP Digital Entertainment Center.

To connect two front speakers, two surround speakers, two surround back speakers, a center speaker, and a subwoofer for eight-channel (7.1 speaker) output:

- 1 Connect the RCA connector end of the Y adapter cables to the Audio Out connectors Front Right, Front Left, Center, Surround Right, Surround Left, Surround Back on the back of your HP Digital Entertainment Center.
- 2 Connect the female 1/8 inch (3.5 mm) mini-jack end of the Y adapters to the Audio Line In cables of the speaker amplifier.

- 3 Plug in the speaker system power. Refer to the speaker documentation.
- 4 Turn on the speaker system.



Some powered speakers can generate (upmix) the 7.1 audio with 5.1 input channels. Refer to your product documentation.

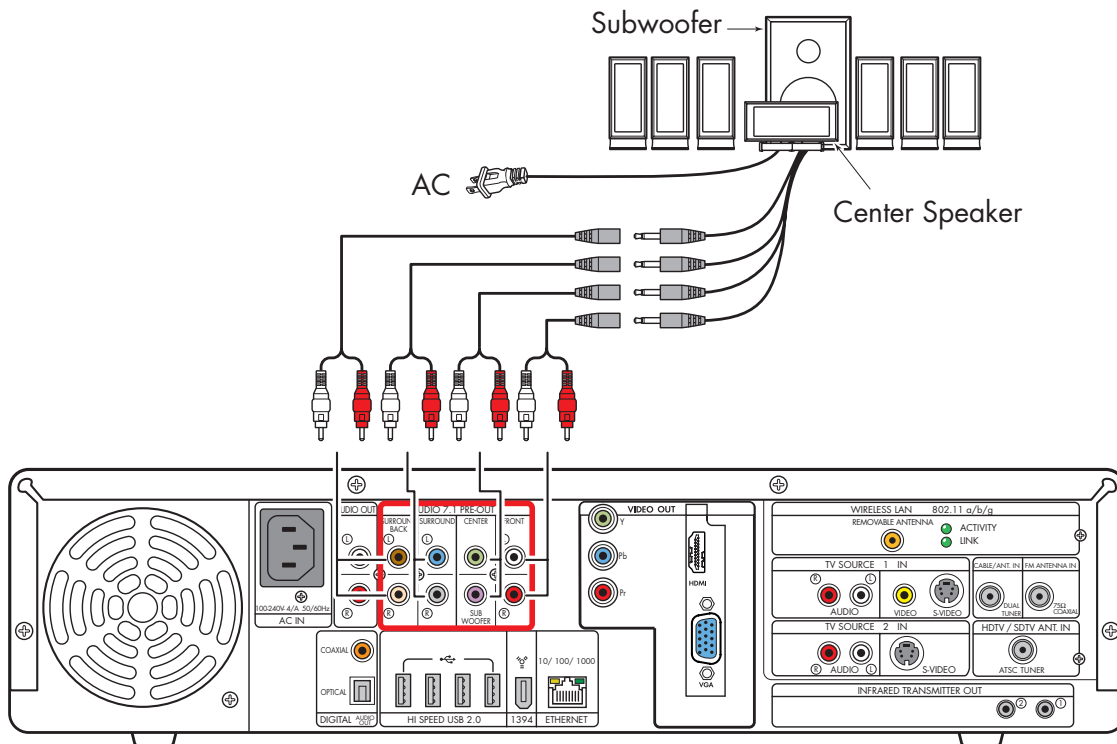

Typical 7.1 powered speaker installation

Digital Powered Speakers

You can install a digital audio system with up to two front speakers, two surround speakers, two surround back speakers, a center speaker, and a subwoofer to your HP Digital Entertainment Center.

Do not connect analog multichannel speaker outputs if you connect the digital output.

You can connect either the coaxial or optical digital audio cable, depending on your system. If you have both cables, connect one cable only.

- Insert optical cords straight in until they click into place.
- Do not bend or tie optical cords.



Some powered speakers can generate (upmix) the 7.1 audio with 5.1 input channels. Refer to your product documentation.

To connect six-channel (5.1 speaker) digital output to a speaker digital input:

- 1 Connect a digital audio coaxial or optical cable to a Digital Audio Out connector on the back of your HP Digital Entertainment Center.
- 2 Connect the digital audio coaxial or optical cable to the speakers.
- 3 Plug in the speaker system power. Refer to the speaker documentation.
- 4 Turn on the speaker system.

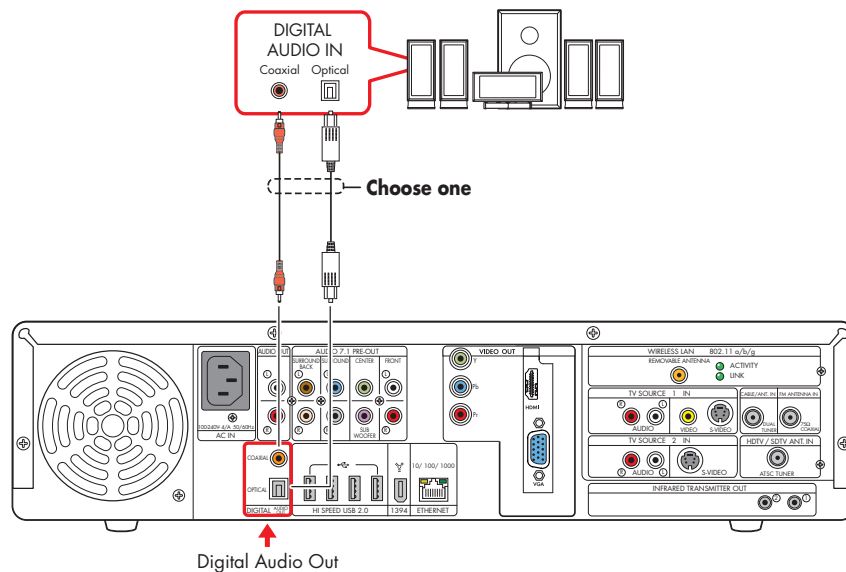

Digital powered speaker installation (5.1 shown)

Monitor Speakers

You can connect powered monitor speakers directly to your HP Digital Entertainment Center.

You may need Y adapter cables.

You can:

- Connect simple left/right stereo 2.0 powered monitor speakers.

Or

- Connect two powered speakers and a subwoofer for 2.1 monitor speaker output.



Monitor speaker configurations and connections may vary. Your system may be different.

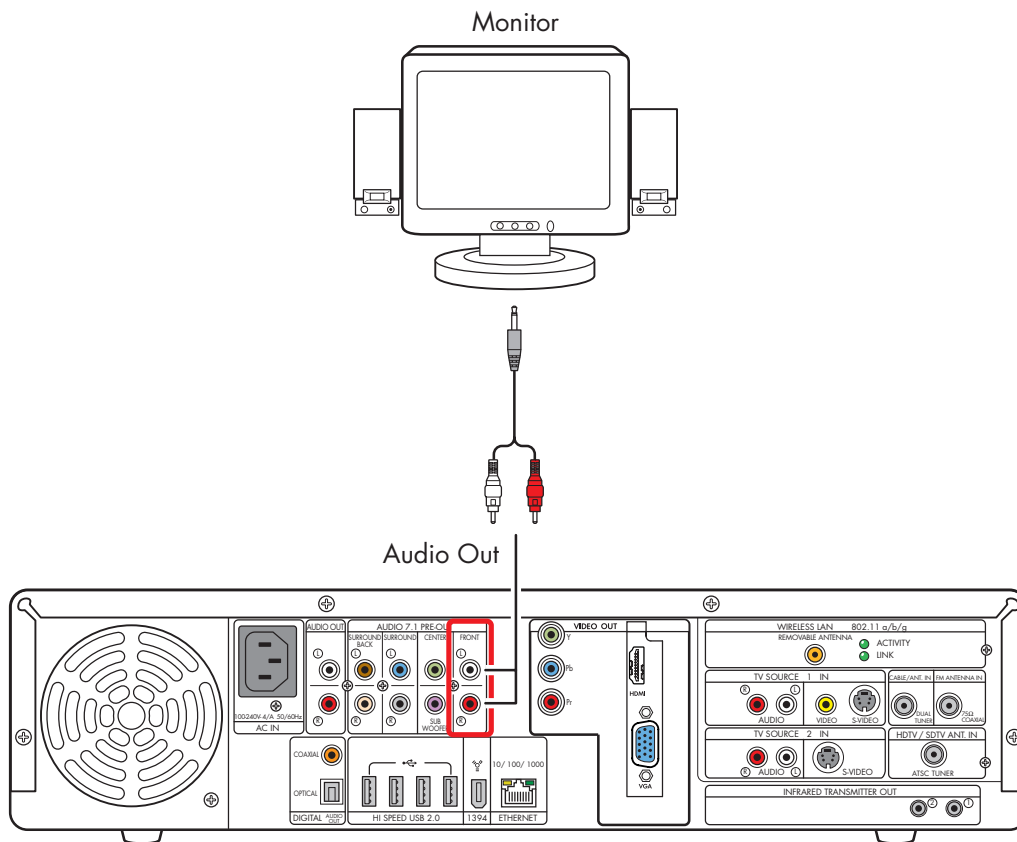

Monitor speaker installation (2.0 shown)

Audio Out Connections

You can connect your existing home stereo or home theater audio equipment to your HP Digital Entertainment Center using the Audio Out stereo connectors on the back panel.

The following diagram shows a typical Audio Out stereo connection. This is only a suggested configuration. Your system may be different.

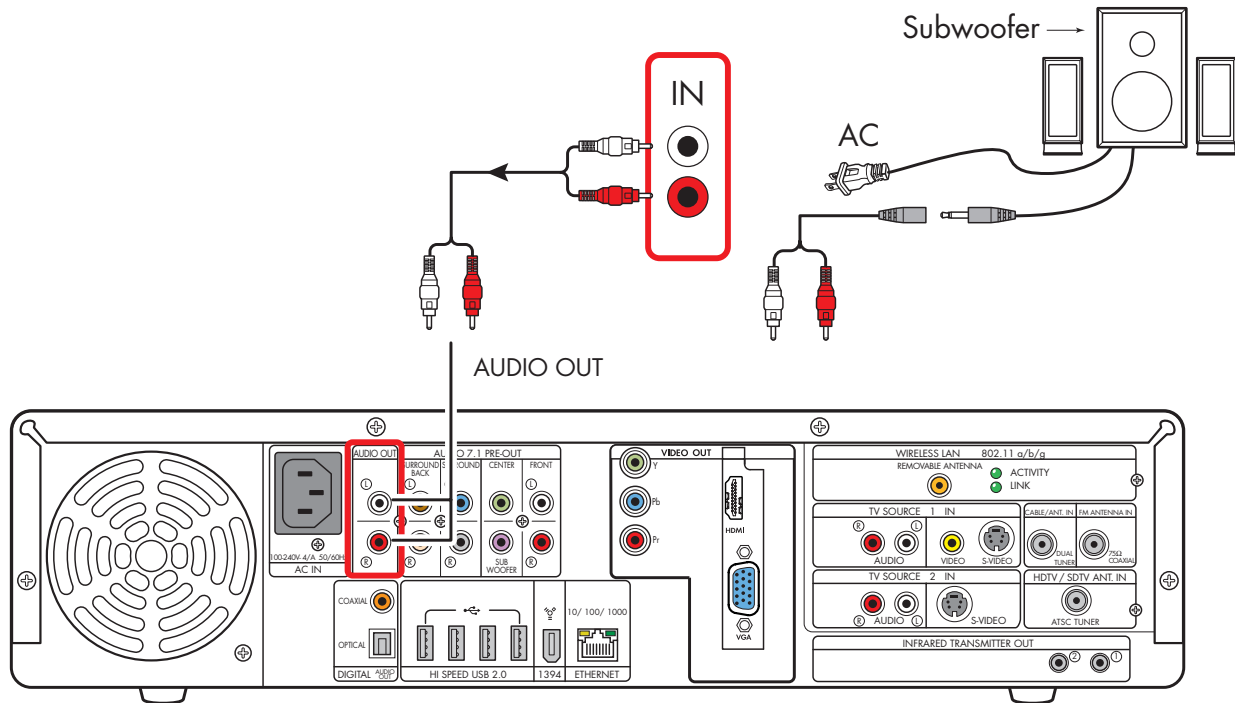

Audio Out stereo connection



If you connect the Audio Out connector to your speakers or stereo, you will not be able to control your volume with the keyboard or with the remote control. The volume is controlled only by using the Master Volume Wave controller.

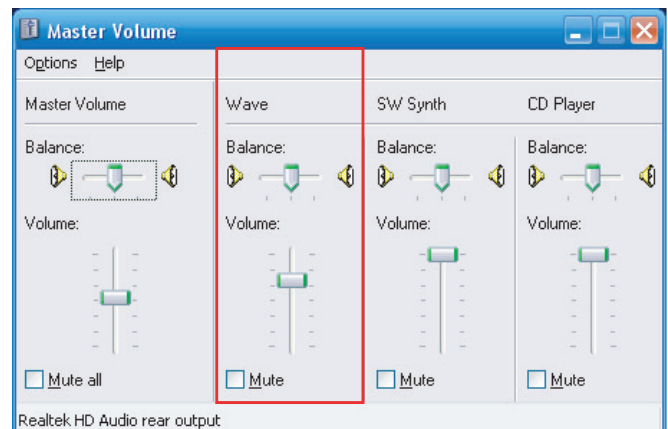

FM Radio Antenna

The HP Digital Entertainment Center includes an FM radio tuner.

To connect the FM radio antenna:

- 1 Plug the FM radio antenna cable into the FM (Tuner) In connector on the back panel (75-Ohm Coaxial).
- 2 You may want to extend the ends of the cable to improve your FM radio signal reception.

The following diagram shows typical FM antenna connections:

■ Indoor antenna
Or

■ Rooftop antenna (sold separately)

This is only a suggested configuration. Your system may be different.

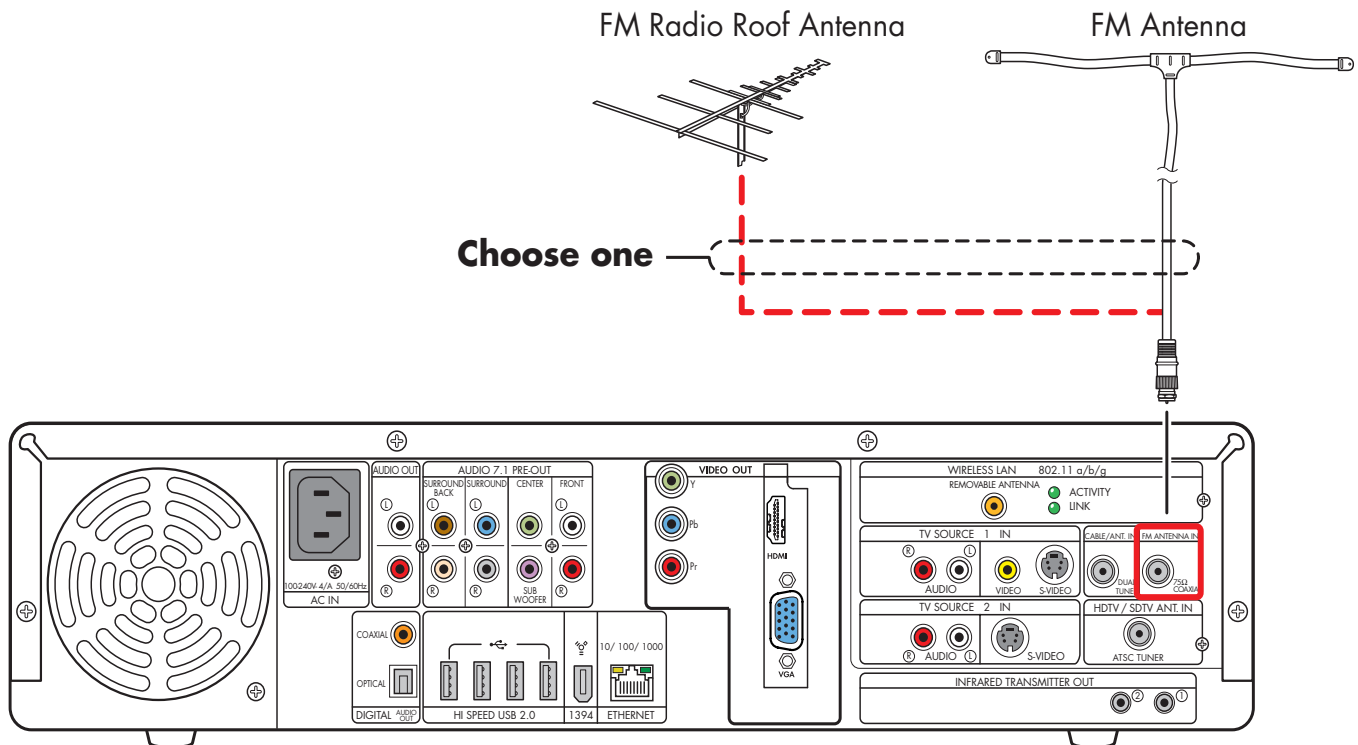

FM radio antenna cable external or internal connection

Connecting Video Out

This chapter describes how to connect the HP Digital Entertainment Center to a TV or display monitor, so you can watch TV and view the screen. It includes the most typical, and some advanced, video output options.

You must have a display such as a TV or monitor connected to the HP Digital Entertainment Center for proper operation. HP Digital Entertainment Centers support many different video options, connections, and configurations of TVs and monitors. Your system may have different equipment.

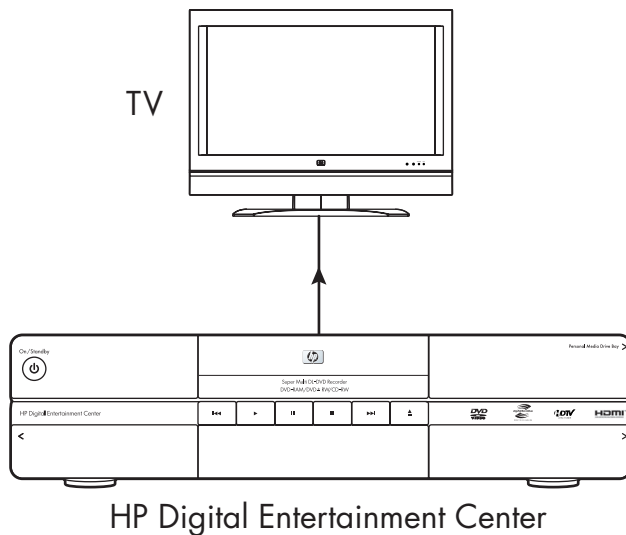

Chapter Contents:

"Video Out Overview" on page 58
"Typical Video Out Connections" on page 62
"Video Out to TV" on page 63
"Video Out from AV Receiver to TV" on page 65
"Video Out to Monitor" on page 67
"Video Out to TV and Monitor" on page 68

Video Out Overview

Video Out Connection Overview

The back panel connector that you hook up to your TV is labeled Video Out.

Choose a Video Out connector and corresponding cable that attaches to the back of your TV:

Standard definition television:

- Component (Y, Pb, Pr)



High definition capable plasma, LCD, or HDTV display:

- Component (Y, Pb, Pr)
- VGA
- HDMI

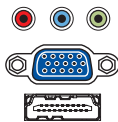

Monitor:

- VGA
- HDMI

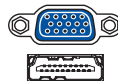

Component video output requires specific configurations for certain display types and resolutions. Go to <http://www.hp.com/support> and select your model number for instructions on using component video.



To connect video equipment with DVI-D connectivity, use the provided DVI-D to HDMI adapter.

The type of video cable you need depends on your TV:

- For component video, see “Component Video Settings” on page 60.

To connect a TV to the HP Digital Entertainment Center, you may need a video cable and an audio cable. Use a video cable to connect the Video Out on the HP Digital Entertainment Center to your TV Video In. These cables are included in the box. You may need other or additional cables, depending on your TV or monitor.

When using an AV receiver, the Video Out cable can be connected directly to a TV and just the audio is connected and switched through an AV receiver, or video and audio are connected and switched through an AV receiver.

Not all AV receivers support signal conversion.

Some HP Digital Entertainment Center models output NTSC only.

Video Out Connectors

(Location, availability, and number of connectors may vary.)

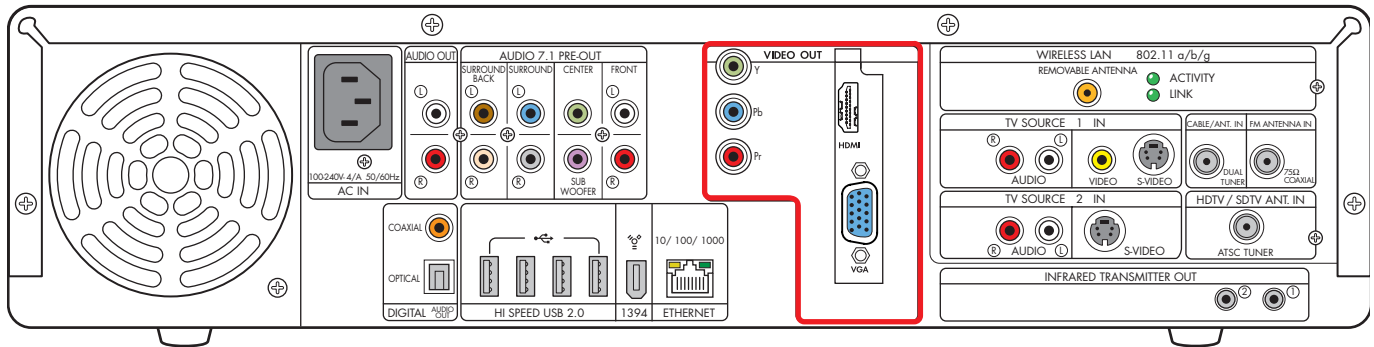

Item	Connector	Type	Color	Cable type
	Component (interlaced or progressive scan) See http://www.hp.com/support for instructions on using component video.	3 RCA jacks	Green: Y Blue: Pb Red: Pr	
	VGA	Analog: 15-pin D-sub Video Out	Blue	
	HDMI — For best picture quality, use the HDMI Video Out.	Digital 19-pin D-Sub Video Out	Silver/Black	

The video connectors are ranked in order of picture quality.

- 1) Use HDMI Video Out for best picture and sound quality.
- 2) DVI Video Out (use HDMI to DVI adapter)
- 3) VGA Video Out
- 4) Component Video Out

Component Video Settings

You must configure settings to view component video on your TV properly. Component video output requires specific configurations for certain display types and resolutions. Go to <http://www.hp.com/support> and select your model number for instructions on using component video.

Overview

You must change the default desktop resolution of 800 x 600 to 640 x 480 for the best DVD playback and Media Center experience. A resolution of 800 x 600 is best for Windows desktop dialog boxes. See "Adjusting the Desktop Display" on page 143. The component video default output is 480i (interlaced) to provide a picture on most TVs. Driver adjustments are required to configure progressive scan for TVs that support progressive scan.

Progressive scan format provides a better desktop viewing experience than interlaced format.

Content-protected DVD playback is limited to the following when component video is connected:

Component format	Desktop resolution
480i (interlaced)	640 x 480 @ 30 Hz
480p (progressive)	640 x 480 @ 60 Hz

TV Display Overview

The HP Digital Entertainment Center allows you to connect to a TV to view the monitor image on a TV screen. With the TV connected, you can view the HP Digital Entertainment Center image, watch TV or DVD movies, or play games on your TV. See "Video Out to TV and Monitor" on page 68.

You must manually set up dual displays (clone). Only either the TV or monitor, not both, will display after initial turn on. See "Dual screen" on page 140.

Audio and Video Switching Overview

AV receiver: You can use your AV receiver as a switch to direct the video to your TV and the audio to your speakers from the HP Digital Entertainment Center. This method gives you the best audio quality, and is easy to switch audio/video inputs through your AV receiver remote.

If your AV receiver has multiple input and output connections, then it has front panel input and output switches.

You must select the correct input and output on the AV receiver front panel or remote control to hear sound and see video.

TV: If you have multiple audio/video inputs on your TV, you can use your TV as an audio/video switch and control inputs through your TV remote.

If your TV has multiple input connections, then it has a front panel input switch.

You must select the correct input and output on the TV front panel or remote control to hear sound and see video.

Monitor: If you have multiple audio/video inputs on your monitor, you can use your monitor as an audio/video switch. You will probably not be able to use a remote control to switch.

If your monitor has multiple input and output connections, then it has a front panel input switch and output switch.

You must select the correct input and output on the monitor front panel to hear sound and see video.



If your video equipment has multiple input and output connections, then it has front panel input and output switches.

You must select the correct input and output from the video equipment front panel or remote control to hear sound and see video.

Using the Remote Control with Your TV

You can use the HP Digital Entertainment Center remote control to change channels and adjust volume if you have a cable box or satellite receiver, have installed the Infrared Transmitter cable, and have configured the remote control after initial turn on.

Always point the HP Digital Entertainment Center remote control at the HP Digital Entertainment Center front panel. The infrared remote sensor, behind the front panel window, receives signals from the remote control.

The HP Digital Entertainment Center includes one or two Infrared Transmitter cables (IR blaster) that are required to control one or two set-top boxes. You must carefully position the Infrared Transmitter cable tip on the set-top box to ensure the set-top box receives the IR signal from the HP Digital Entertainment Center. See "Infrared Transmitter Installation" on page 99.

Typical Video Out Connections

This section describes how to hook up the Video Out connectors on the back panel of the HP Digital Entertainment Center into your home system so you can watch TV.

These are only suggested configurations. Your system may be different. Select the configuration that most closely matches your home system.

You may set up your HP Digital Entertainment Center for the following supported configurations:







Display/video configuration	See:
From HP Digital Entertainment Center to TV through a direct connection	"Video Out to TV" on page 63
From HP Digital Entertainment Center through an AV receiver, to a TV	"Video Out from AV Receiver to TV" on page 65
From HP Digital Entertainment Center to a monitor through a direct connection	"Video Out to Monitor" on page 67
From HP Digital Entertainment Center to a TV and monitor, dual-display option (You must manually set dual displays.)	"Video Out to TV and Monitor" on page 68
Other Video Equipment	"Connecting Video Equipment" on page 101

Then see:
"Connecting TV Source In" on page 71
"Configuring Video" on page 140

Video Out to TV

Switching: If you have multiple audio/video inputs on your TV, you can use your TV as an audio/video switch and control inputs through your TV remote.

Connectors: Choose a Video Out connector and corresponding cable that attaches to the back of your TV:

Standard definition TV	High definition display	Monitor
Component (Y, Pb, Pr) 	Component (Y, Pb, Pr) 	
	VGA 	VGA 
	HDMI 	HDMI 

Equipment: The TV and some cables are sold separately. Refer to the documentation that came with your TV/display. You can also connect a video projector using this procedure.

Configuration: You can adjust the TV display, after initial turn on, using the Media Center software. See "Initial Configuration" on page 127.

Procedure: Connect a video cable from the HP Digital Entertainment Center back panel Video Out directly to the TV Video In.



Component video output requires specific configurations for certain display types and resolutions. Go to <http://www.hp.com/support> and select your model number for instructions on using component video.

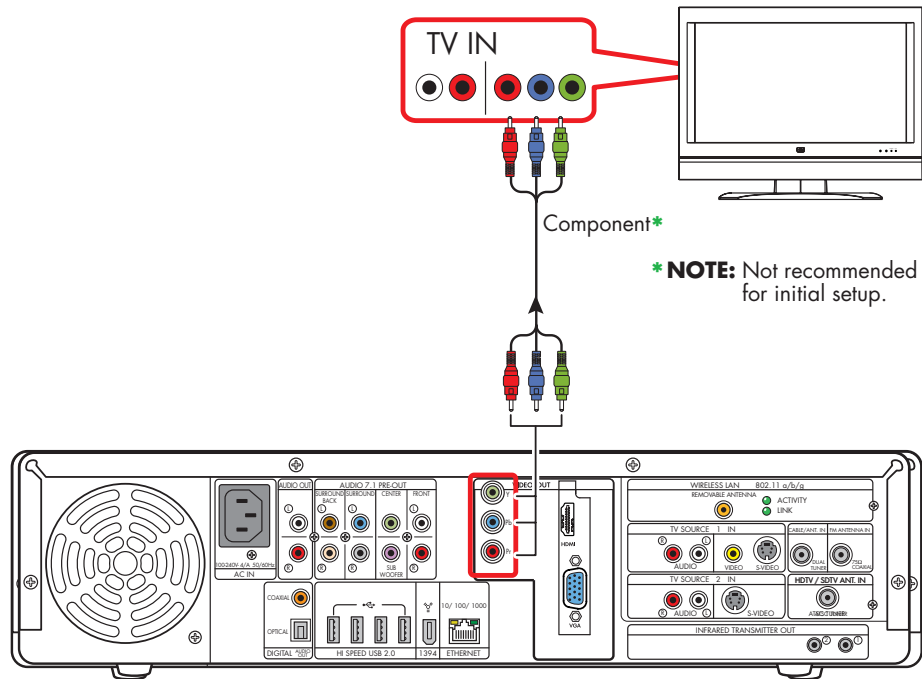

Video out to standard TV

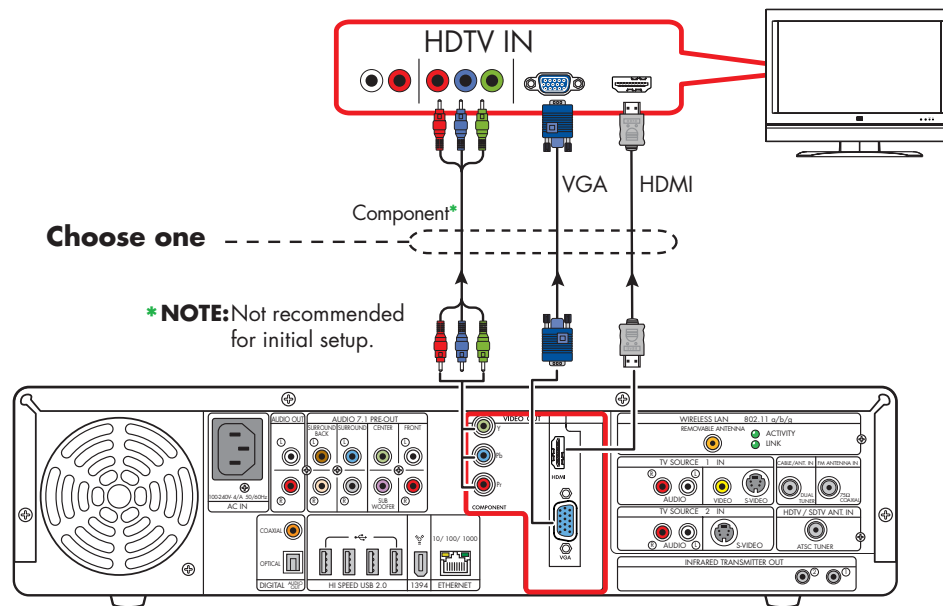







Video out to high-definition capable HDTV

Video Out from AV Receiver to TV

Switching: Switch audio and video through your AV receiver if your AV receiver switches video and has the correct connections. This method gives you the best audio quality, and you can easily switch audio/video inputs through your AV receiver remote.

Connectors: Choose a Video Out connector and corresponding cable that attaches to the back of your TV:

Standard definition TV	High definition display	Monitor
Component (Y, Pb, Pr) 	Component (Y, Pb, Pr) 	
	VGA 	VGA 
	HDMI 	HDMI 

Equipment: The TV, AV receiver, and some cables are sold separately. See the documentation that came with your TV and AV receiver.

Configuration: You can adjust the TV display, after initial turn on, using the Media Center software settings. See "Initial Configuration" on page 127.

Procedure:

- 1 Connect a video cable from the HP Digital Entertainment Center back panel Video Out to the AV receiver Video In.
- 2 Connect a video cable from the AV receiver Video Out to the TV Video In. Use the same connector type if your AV receiver does not support cross-connecting.

If your TV and AV receiver has multiple input and output connections, then it has front panel input and output switches.

You must select the correct input and output from the TV and AV receiver front panel or remote control to hear sound and see video.

Component video output requires specific configurations for certain display types and resolutions. Go to <http://www.hp.com/support> and select your model number for instructions on using component video.

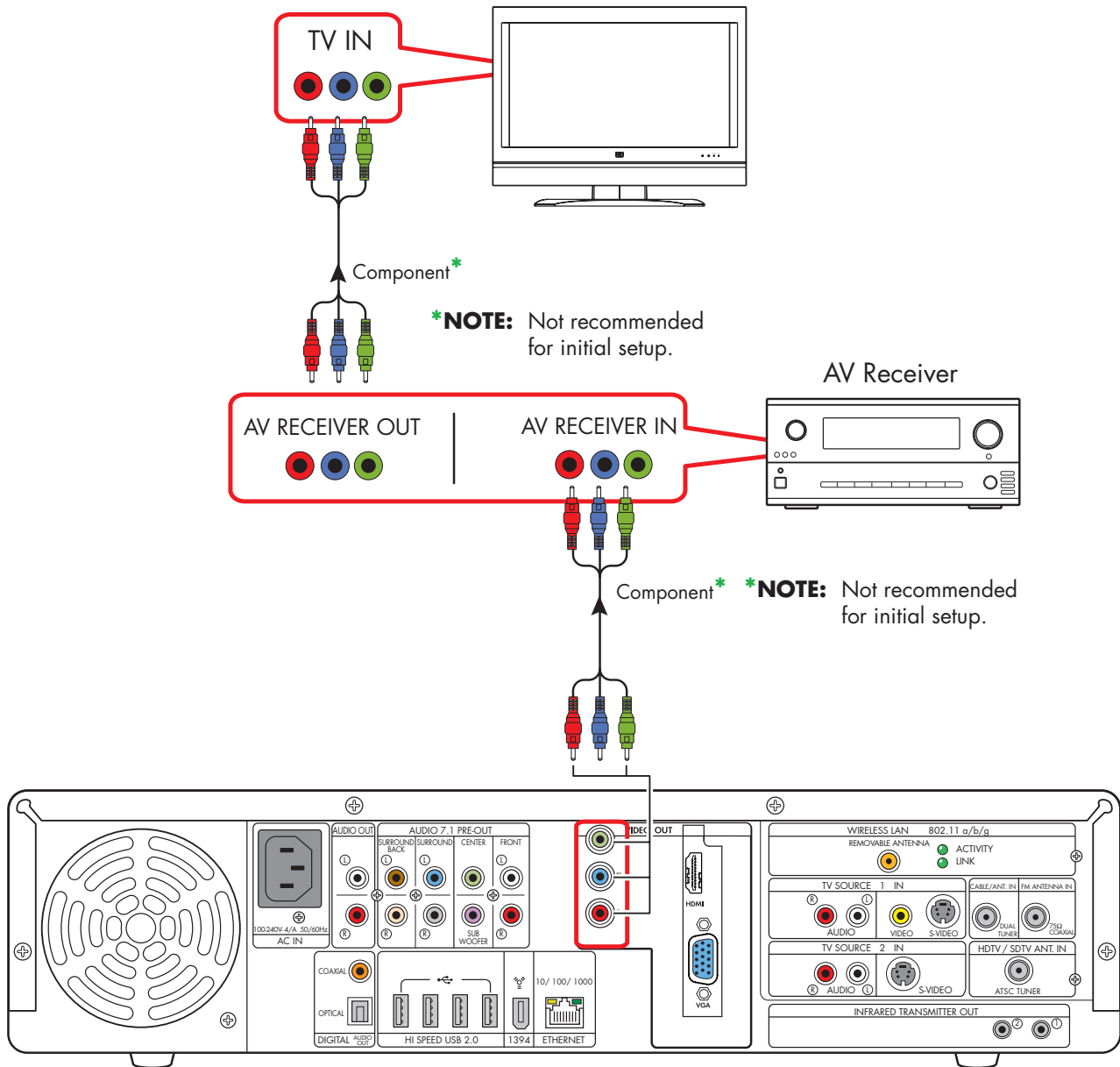

TV Out (through AV receiver)

Video Out to Monitor

Switching: If you have multiple audio/video inputs on your monitor, you can use your monitor as an audio/video switch. You will probably not be able to use a remote control as a switch.

Connectors: For a monitor, choose one of the following Video Out connectors and cables:

- VGA
- HDMI

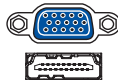

Equipment: The monitor and some cables may not be included with the HP Digital Entertainment Center. See the documentation that came with your monitor.

Configuration: You can adjust the monitor display, after initial turn on, using the Media Center software. See "Initial Configuration" on page 127.

Procedure: Connect a monitor video cable from the HP Digital Entertainment Center back panel Video Out directly to the monitor Video In.



If your monitor has multiple input connections, then it has a front panel input switch. You must select the correct input from the monitor front panel or remote control to hear sound and see video.

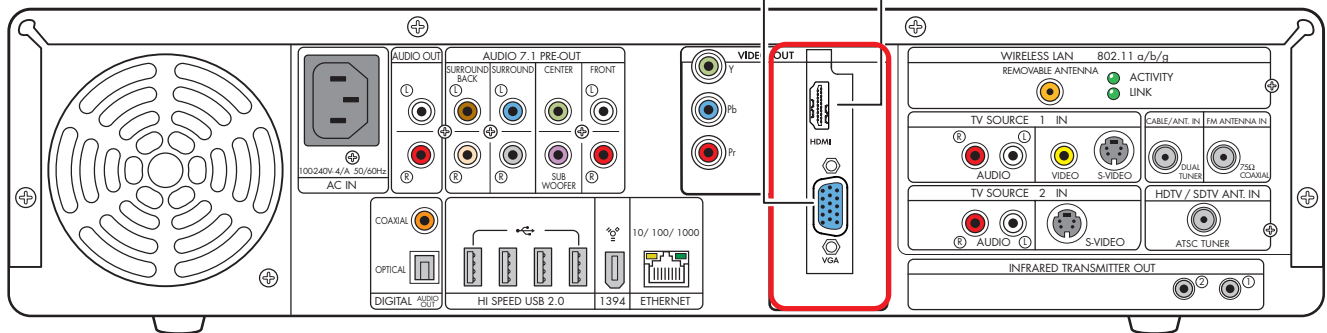
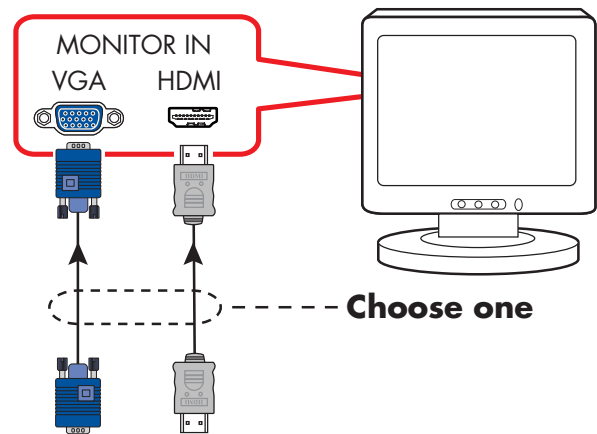







Monitor out

Video Out to TV and Monitor

Switching: If you have multiple audio/video inputs on your TV or monitor, you can use your TV or monitor as an audio/video switch. You can use a TV remote control to switch inputs. If your AV receiver switches video and has the correct connections, you can connect your TV or monitor through your AV receiver.

Connectors: Choose Video Out connectors and corresponding cables that attach to the back of your TV and monitor:

Standard definition TV	High definition display	Monitor
Component (Y, Pb, Pr) 	Component (Y, Pb, Pr) 	
	VGA 	VGA 
	HDMI 	HDMI 

You can use the following combinations to connect your TV and monitor:

Display	Use with
VGA	Component (Y, Pb, Pr) DVI
HDMI	Component (Y, Pb, Pr) VGA

You cannot view any combination of Component (Y, Pb, Pr) DVI, and VGA Video Out at the same time with dual displays.

Equipment: The TV, monitor, and some cables may not be included with the HP Digital Entertainment Center. See the documentation that came with your TV and monitor.

Configuration: You can adjust the TV and monitor displays, after initial turn on, using the Media Center software. See "Initial Configuration" on page 127.

Procedure:

- 1 Connect a monitor video cable from the HP Digital Entertainment Center back panel Video Out directly to the monitor Video In. Use the VGA or HDMI Video Out connectors.
- 2 Connect your TV to the HP Digital Entertainment Center back panel. Use the Component (Y, Pb, Pr) Video Out connectors for standard definition TVs.
- 3 After initial turn on, you will need to activate dual displays. See "Dual screen" on page 140.



Component video output requires specific configurations for certain display types and resolutions. Go to <http://www.hp.com/support> and select your model number for instructions on using component video.



If your TV or monitor has multiple input connections, select the correct input on the TV or monitor.

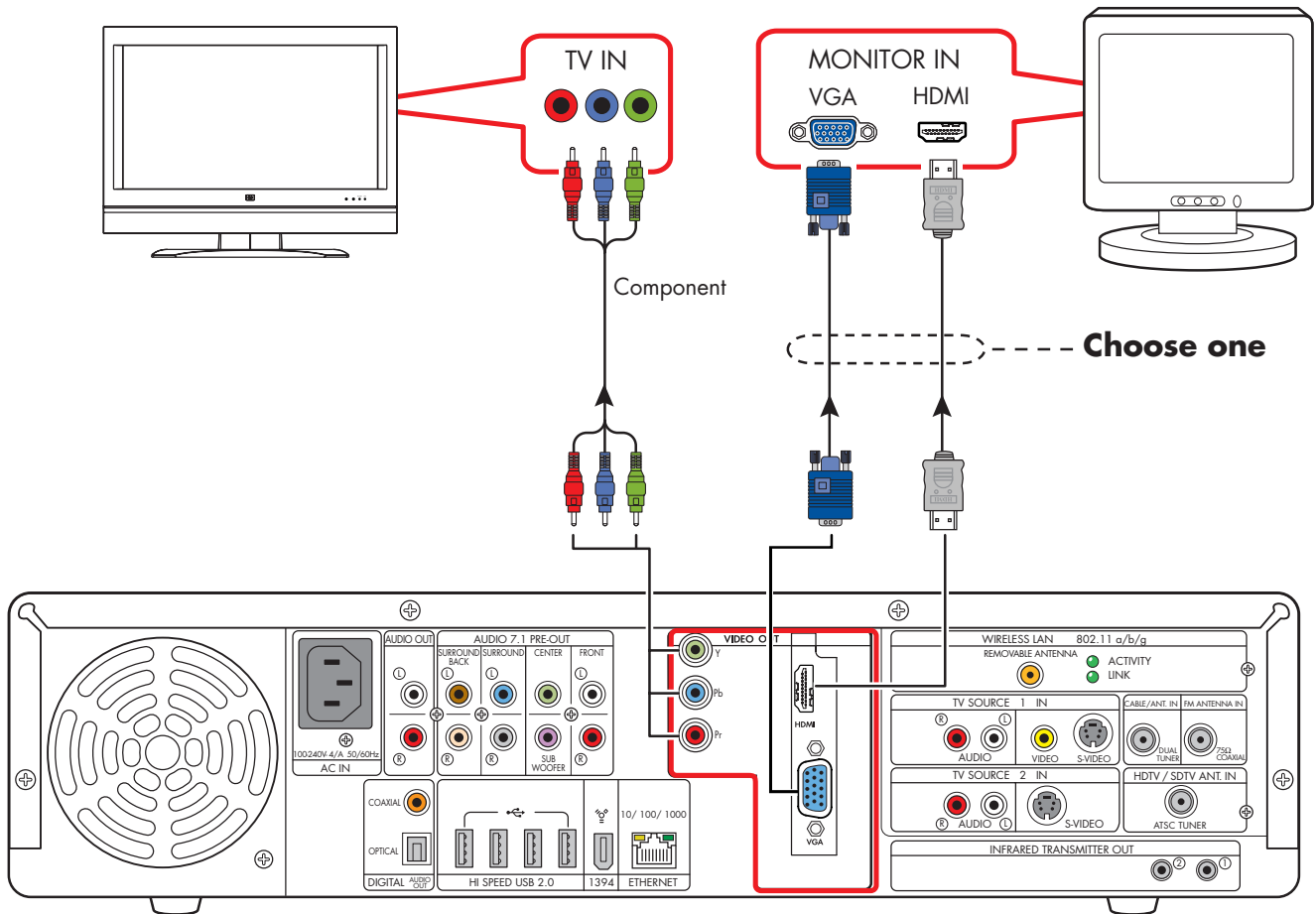

TV (standard definition shown) and monitor out

Connecting TV Source In

This chapter describes how to connect TV source input from a set-top box such as a cable box or satellite receiver to the HP Digital Entertainment Center. Infrared Transmitter cable installation is also included.

You connect the HP Digital Entertainment Center to an existing setup for your TV signal source. This chapter includes the most typical, and some advanced, input options.

The HP Digital Entertainment Center supports many different video source input options, connections, and set-top-box configurations, such as a cable box or satellite receiver. Your home system may have different components.

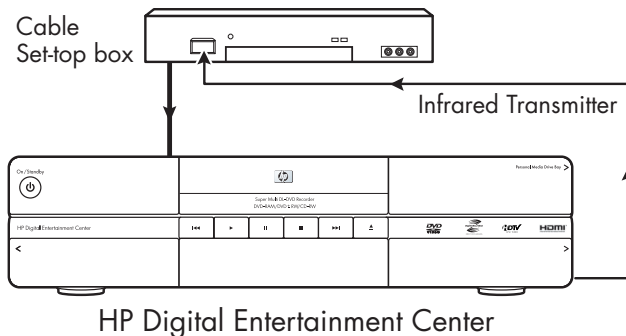

Chapter Contents:

"TV Source Overview" on page 72
"Typical TV Source Connections" on page 78
"Antenna Connection" on page 80
"Cable Connection" on page 83
"Satellite Connection" on page 93
"Infrared Transmitter Connection" on page 97



For additional information on connecting the cable box or satellite receiver, refer to the documentation that came with your equipment and the *Start Here* booklet included.

TV Source Overview

TV Signal Source Overview

You must connect a TV signal to the HP Digital Entertainment Center for proper operation. You can attach standard, analog NTSC TV and high-definition, digital HDTV ATSC sources.

The back panel TV Source connectors are:

- TV Source 1 In
- TV Source 2 In
- Cable/Antenna In (NTSC) RF
- HDTV/SDTV Ant. In (ATSC) RF antenna



An ATSC tuner that supports high-definition TV is included with select HP Digital Entertainment Center models only.

NTSC Standard TV

The NTSC back panel connectors are TV Source 1 In and TV Source 2 In:

- For an NTSC cable TV box, digital cable box, or satellite receiver use TV Source 1 In or TV Source 2 In (select models only).
- For an NTSC analog cable RF coaxial connector use Cable/Antenna In. For dual-tuner systems, the Cable/Antenna In RF connector splits internally.

A set-top cable TV box is provided by your cable TV provider to unscramble premium channels.

For Dual Tuner configurations, both TV sources must be of the same type: either cable TV, digital cable TV, satellite TV, or antenna. The TV sources must also have the same, identical channel lineup; for example, if you are using two satellite TV sources they must provide the exact same channels. All TV viewing and scheduling is provided through the Television Program Guide in Media Center, so both TV sources must have identical Television Program Guides.

The HP Digital Entertainment Center records television and allows you to control the television channels. The HP Digital Entertainment Center has two tuner configurations available:

Single-tuner TV Source 1 In	A single tuner allows you to watch or record one program only in NTSC.
Dual-tuner option TV Source 2 In	You can have dual TV inputs, if your HP Digital Entertainment Center includes the two TV tuner option. You can watch a show on one channel while Media Center records another show on a different channel. Or you can record two different programs at the same time, using two tuners in NTSC.

ATSC high-definition TV

If your HP Digital Entertainment Center includes an optional HDTV/SDTV Ant. In tuner card and dual NTSC tuner card configuration, you can view and record ATSC channels. Media Center supports over-the-air ATSC digital TV.

Over-the-air ATSC digital TV requires a UHF/VHF antenna (sold separately) to receive the digital signal. Your location must be within an HDTV ATSC broadcast area.

The ATSC high-definition DTV (Digital TV) source back panel connector is as follows:

- HDTV/SDTV Ant. In connected to a UHF/VHF antenna.

See the following section for more information on HDTV. Then see the instructions to install HDTV ATSC.

Connecting an ATSC antenna

You can attach an indoor or outdoor UHF/VHF antenna to the HP Digital Entertainment Center to watch HDTV ATSC through the VHF or UHF channels. A UHF/VHF antenna receives HDTV ATSC channels, depending on the quality (gain) of the antenna, geographic location, and broadcast reception strength.

An internal or external roof antenna is sold separately. You might have to reposition the antenna for best reception. Position the antenna based on the following general criteria:

- Higher; the ideal position is above the roofline.
- Closer to or facing the broadcast tower.
- Larger for stronger signals.
- Outdoor for less interference.

Refer to <http://www.antennaweb.org> for more information about:

- The channels available in your area. The channels may be color coded by zone.
- Selecting the kind of antenna you need depending on the channels you want to receive. Match your antenna to your zone.
- The direction to point your antenna.
- Positioning an HDTV antenna for best reception.



You can also attach an internal or external roof VHF antenna to the HP Digital Entertainment Center to watch NTSC channels.

Additional HDTV Information

What is HDTV?

HDTV (High-definition Television) is the highest quality DTV standard. HDTV provides increased picture detail (720p, 1080i) with a widescreen 16:9 aspect ratio and higher quality audio such as surround sound, on a display that supports digital TV. HDTV/SDTV Ant. In is the connector on the back of your HP Digital Entertainment Center that you connect the ATSC signal to.

SDTV (Standard-definition Television) is the lowest quality DTV standard.

ATSC (Advanced Television Systems Committee) is the official name of the DTV picture format that is in use in the United States and North America. The tuner inside your HP Digital Entertainment Center is ATSC-capable.

DTV (Digital Television) is the umbrella term used to describe the new digital television way of transmitting television signals. DTV includes many formats of high-definition TV that can broadcast an image resolution of up to 2 million pixels.

NTSC (National Television Systems Committee) is standard (analog) TV. Standard TV broadcasts an image resolution of about 210,000 pixels and is distributed today through antenna, cable, digital cable, or satellite.

About digital TV in Media Center

Digital TV for Windows® XP Media Center Edition 2005 is available in the United States only. Refer to the *Readme for Update 1 for Windows XP Media Center Edition 2005 with HDTV* for all digital TV requirements.

Refer to the Microsoft Web site at:
<http://www.microsoft.com>

TV Source Connectors Overview

Your standard television set-top box has one or more of the following video output connectors and cables:

- Coaxial (RF)
- Video (composite)
- S-video



Do not switch video types such as connecting S-video In to TV Source 1 and Composite Video In to TV Source 2 or a Coaxial In and a Composite Out. Not all set-top boxes and AV receivers support signal conversion.

The type of video cable you need depends on your set-top box:

- If your set-top box has an S-video jack, you need an S-video cable to connect the HP Digital Entertainment Center to your set-top box. An S-video cable provides separate color and black-and-white image signals, and delivers a sharper image than a composite video cable.
- If your set-top box has a composite video jack, you need a composite video cable.
- If you are connecting dual NTSC set-top box sources to the HP Digital Entertainment Center dual NTSC tuner with an composite video connection, use a composite to S-video adapter (sold separately) on TV Source 2 in.

You may need other or additional cables, depending on your TV signal source.

Connecting a set-top box

A standard cable set-top box has only NTSC channels, but you can connect a UHF/VHF antenna to view HDTV ATSC channels also.









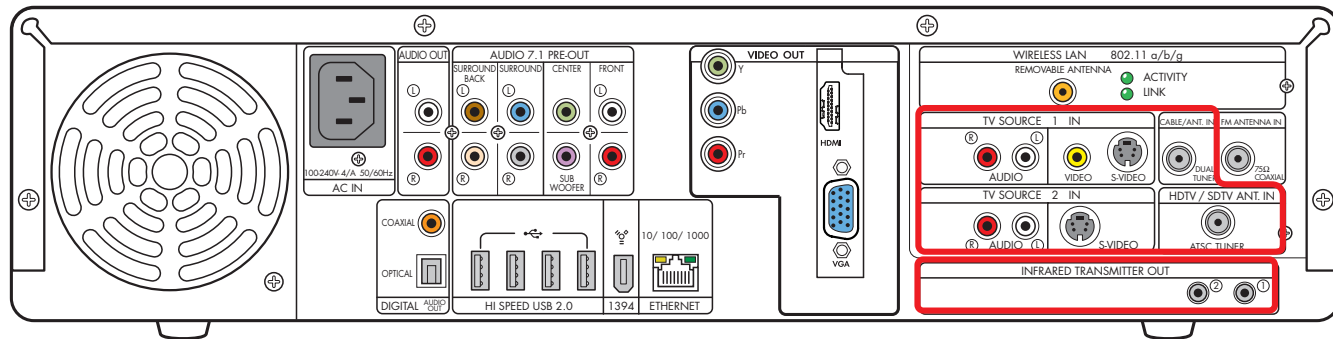

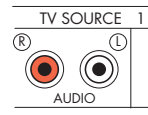



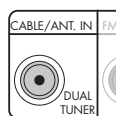

A set-top cable TV box is provided by your cable TV provider to unscramble premium channels. You cannot record digital TV if using the HP Digital Entertainment Center with an HDTV cable box or HDTV satellite box. Use an antenna to record digital TV.

If you can receive HDTV channels through cable or satellite providers, connect the signal directly to your TV/display. Refer to your TV/display documentation.

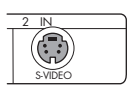
TV Source Connectors

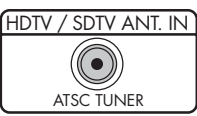
(Location, availability, and number of connectors may vary.)

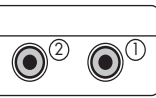

Item	Connector	Type	Color	Cable
	Audio TV Source 1 In	RCA jacks	White: Left Red: Right	
	Video (composite) TV Source 1 In	RCA jack	Yellow	
	S-video (4-pin) TV Source 1 In	Y/C video Analog 4-pin	Black	
	Cable/Antenna In With internal splitter to dual-tuners	Coaxial	Silver	
	Audio TV Source 2 In (Select models only)	RCA jacks	White: Left Red: Right	
	S-video TV Source 2 In (select models only)	Y/C video Analog 4-pin	Black	
	HDTV/SDTV Ant. In	Coaxial (from UHF/VHF antenna)	Silver	
	Infrared Transmitter Out	2 ports: 1/8 inch (3.5 mm) mini-jacks	Silver	

Additional cables to install the HP Digital Entertainment Center are sold separately.

Typical TV Source Connections

These are only suggested configurations. Your system may be different.

Select the configuration that most closely matches your home system:

TV source type	Display/video configuration	Connector	See:
Antenna	Standard NTSC from UHF/VHF antenna	Cable/Ant. In	"Antenna (NTSC)" on page 80
	HDTV ATSC from UHF/VHF antenna	HDTV/SDTV Ant. In	"Antenna (ATSC)" on page 81
	NTSC from UHF/VHF antenna ATSC from UHF/VHF antenna	Cable/Ant. In HDTV/SDTV Ant. In	"Antenna (NTSC and ATSC)" on page 82
NTSC cable and ATSC antenna	NTSC analog cable directly from the wall (without a set-top box) and ATSC from UHF/VHF antenna	Cable/Ant. In and HDTV/SDTV Ant. In	"Cable (NTSC) and Antenna (ATSC)" on page 83
	One NTSC cable TV set-top box and ATSC from UHF/VHF antenna	TV Source 1 In and HDTV/SDTV Ant. In Or Cable/Ant. In and HDTV/SDTV Ant. in	"One Cable TV Box or Digital Cable Receiver (NTSC) and Antenna (ATSC)" on page 84
	Two NTSC cable TV set-top boxes and ATSC from UHF/VHF antenna	TV Source 1 In TV Source 2 In HDTV/SDTV Ant. In	"Two Cable TV Boxes, or Two Digital Cable Receivers (NTSC) and Antenna (ATSC)" on page 86
NTSC digital cable or satellite and ATSC antenna	One NTSC digital cable or satellite receiver and ATSC from UHF/VHF antenna	TV Source 1 In and HDTV/SDTV Ant. In Or Cable/Ant. In and HDTV/SDTV Ant. In	"One Cable TV Box or Digital Cable Receiver (NTSC) and Antenna (ATSC)" on page 84
	Two NTSC digital cable or satellite receivers and ATSC from UHF/VHF antenna	TV Source 1 In TV Source 2 In HDTV/SDTV Ant. In	"Two Cable TV Boxes, or Two Digital Cable Receivers (NTSC) and Antenna (ATSC)" on page 86

TV source type <i>(continued)</i>	Display/video configuration	Connector	See:
NTSC cable	Cable directly from the wall (without a cable TV set-top box or digital cable receiver)	Cable/Ant. In	"Cable Only (NTSC)" on page 88
	One cable TV set-top box or digital cable receiver	TV Source 1 In Or Cable/Ant. In	"One Cable TV Box or Digital Cable Receiver (NTSC)" on page 89
	Two cable TV set-top boxes, or digital cable receivers	TV Source 1 In TV Source 2 In	"Two Cable TV Boxes, or Two Digital Cable Receivers" on page 91
NTSC satellite	One satellite receiver	TV Source 1 In Or Cable/Ant. In	"One Satellite Receiver (NTSC)" on page 93
	Two satellite receivers	TV Source 1 In TV Source 2 In	"Two Satellite Receivers (NTSC)" on page 95
NTSC and ATSC digital cable or satellite	One NTSC and ATSC digital cable or satellite receiver	TV Source 1 In (to record HDTV in standard format)	Connect the cable ATSC signal directly to your TV/display to view HDTV. Refer to the TV/display documentation.
	Two NTSC and ATSC digital cable or satellite receivers	TV Source 1 In and TV Source 2 In (to record HDTV in standard format)	Connect the cable ATSC signal directly to your TV/display to view HDTV. Refer to the TV/display documentation.

Then see:
"Infrared Transmitter Connection" on page 97 (cable TV box, digital cable receiver, or satellite receiver only)
"Connecting Video Equipment" on page 101

Antenna Connection

(Location, availability, and number of connectors may vary.)

Antenna (NTSC)

If you are using a NTSC UHF/VHF broadcast television antenna (sold separately) with no cable TV box, digital cable box, or satellite receiver, do the following to connect the TV signal source:

- 1 Plug the connector of a coaxial cable from your external or internal TV antenna into the Cable/Ant. In connector on the back of the HP Digital Entertainment Center.
- 2 Turn the connector to tighten it.

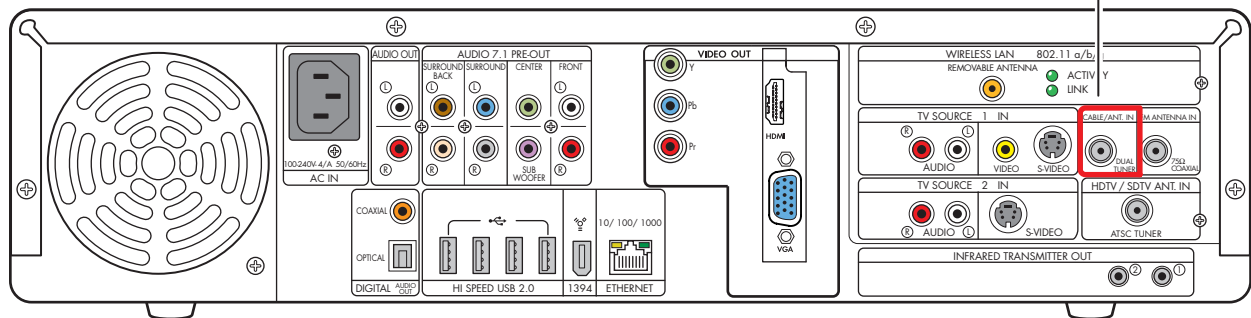
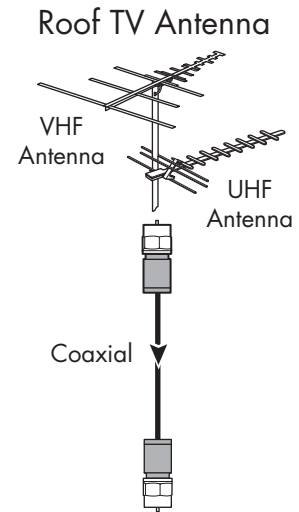

TV signal source – TV antenna

Antenna (ATSC)

To connect an HDTV signal source to your HP Digital Entertainment Center, do the following:

- 1 Connect a coaxial cable from your UHF/VHF antenna into the HDTV/SDTV Ant. In connector on the back of the HP Digital Entertainment Center.
- 2 Turn the connector to tighten it.

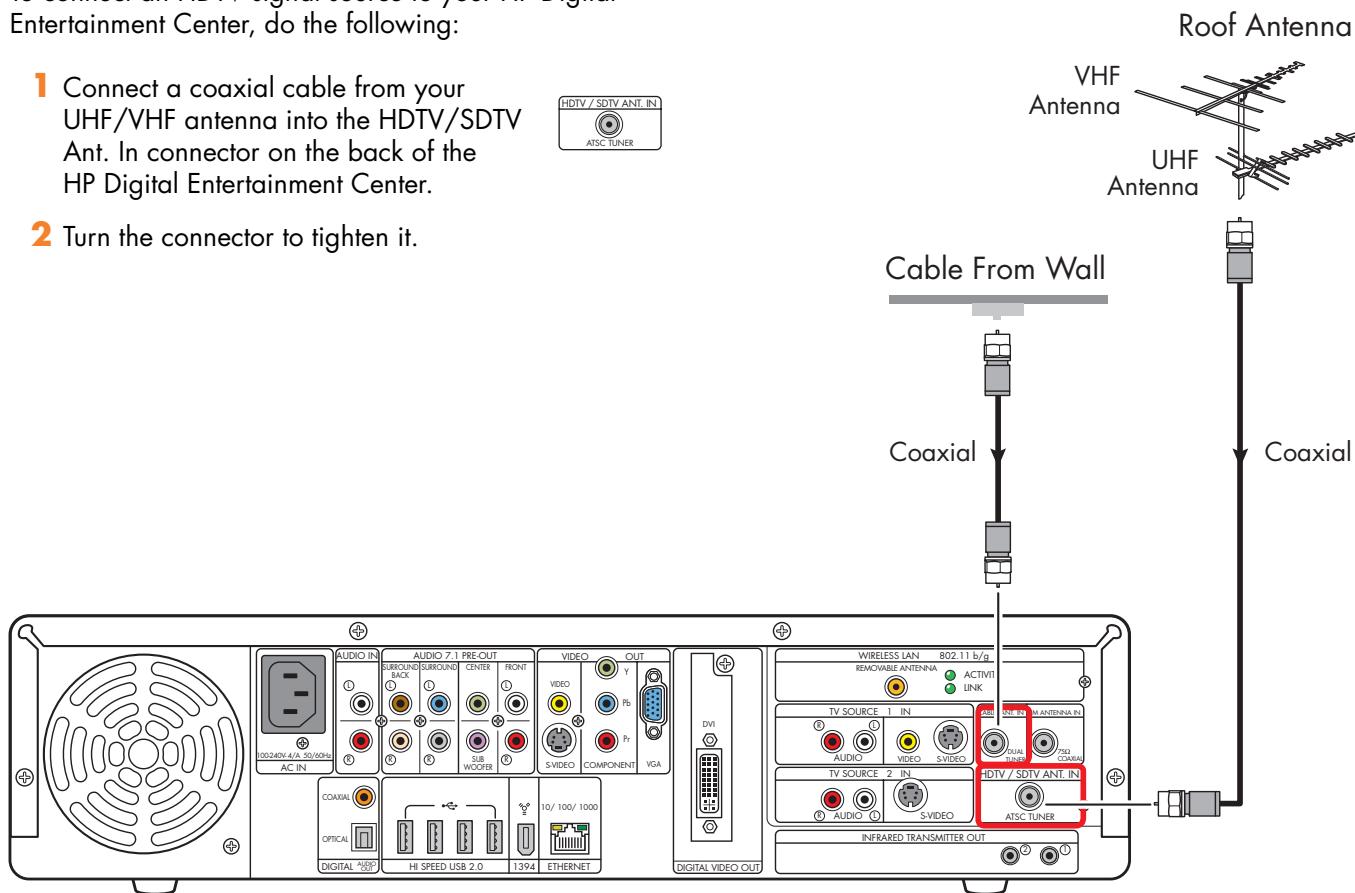

TV signal source – HDTV antenna

Antenna (NTSC and ATSC)

If you are using a VHF and UHF broadcast television antenna (sold separately) with no cable TV box, digital cable box, or satellite receiver, do the following to connect the NTSC and ATSC TV signal source to your HP Digital Entertainment Center:

- 1 Install a splitter (provided) as shown in the following illustration (select models only). Connect the splitter input to the antenna (outdoor shown).
- 2 Connect two coaxial cables to the splitter outputs. Turn the connectors to tighten them.
- 3 Connect a coaxial cable into the Cable/Ant. In connector on the back of the HP Digital Entertainment Center. Turn the connector to tighten it.
- 4 Connect a coaxial cable into the HDTV/SDTV Ant. In connector on the back of the HP Digital Entertainment Center. Turn the connector to tighten it.

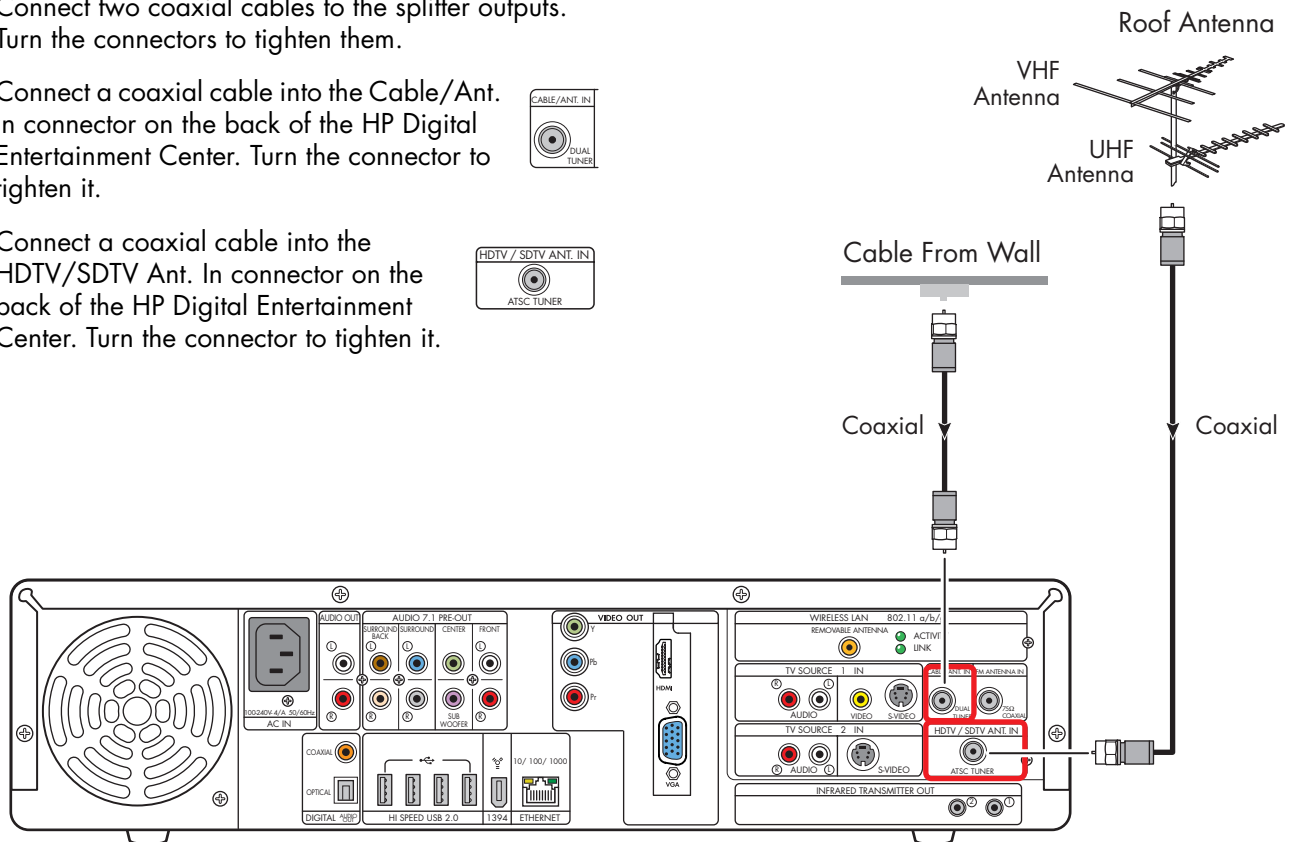

HDTV and standard signal source – TV antenna

Cable Connection

(Location, availability, and number of connectors may vary.)

Cable (NTSC) and Antenna (ATSC)

To connect standard cable without a set-top box and a HDTV/SDTV Ant. In input to your HP Digital Entertainment Center, do the following to connect the NTSC and ATSC TV signal sources:

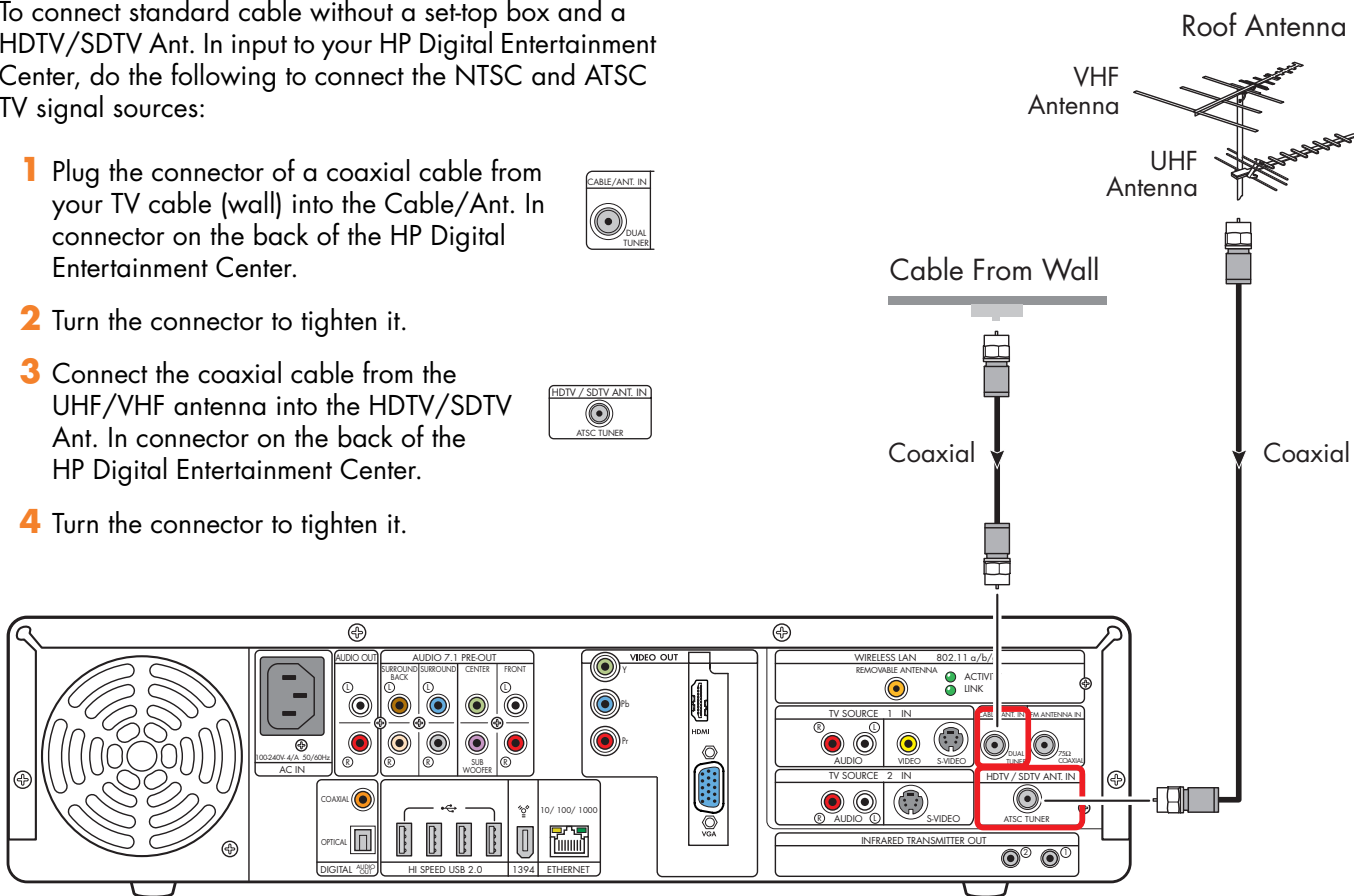

- 1 Plug the connector of a coaxial cable from your TV cable (wall) into the Cable/Ant. In connector on the back of the HP Digital Entertainment Center.
- 2 Turn the connector to tighten it.
- 3 Connect the coaxial cable from the UHF/VHF antenna into the HDTV/SDTV Ant. In connector on the back of the HP Digital Entertainment Center.
- 4 Turn the connector to tighten it.



TV signal source NTSC cable and ATSC UHF/VHF antenna

One Cable TV Box or Digital Cable Receiver (NTSC) and Antenna (ATSC)

To connect a standard set-top box (sold separately) and an HDTV/SDTV Ant. In input to your HP Digital Entertainment Center using a standard set-top box, satellite receiver, or digital cable receiver with S-video or composite video output, do the following:

- 1** Make sure that a coaxial cable connector from your cable TV source (wall) is plugged into the set-top box or digital cable receiver In connector.
- 2** Connect a video cable:
 - a** Choose a video out connector:
 - Coaxial (RF) 
 - Video (composite) 
 - S-video 
 - b** Connect the video cable from the set-top box or digital cable receiver back panel Video Output connector.
 - c** Connect the video cable into the HP Digital Entertainment Center back panel TV Source 1 In connector.
- 3** Connect stereo audio cables (skip this step if using coaxial [RF]):
 - a** From the set-top box or digital cable receiver back panel Audio Out right (red) and Audio Out left (white) connectors.
 - b** Into the HP Digital Entertainment Center back panel TV Source 1 In Audio right (red) and Audio left (white) connectors.
- 4** Connect the coaxial cable from the UHF/VHF antenna into the HDTV/SDTV Ant. In HDTV/SDTV Ant. In connector on the back of the HP Digital Entertainment Center.
- 5** Connect the set-top box Infrared Transmitter cable (required for signal). See "Infrared Transmitter Connection" on page 97.

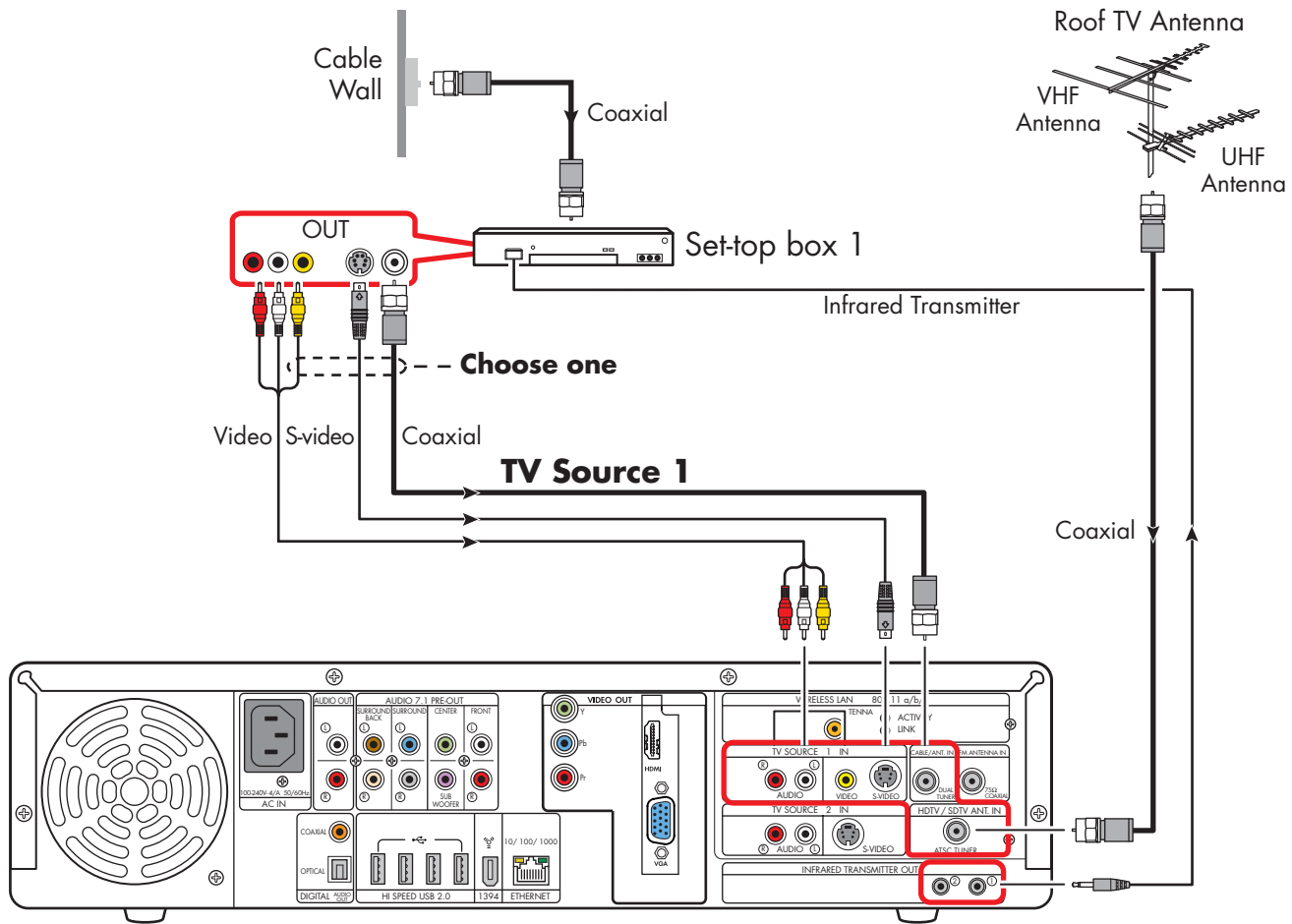

TV signal source – one cable TV or digital cable box (NTSC) and ATSC UHF/VHF antenna

Two Cable TV Boxes, or Two Digital Cable Receivers (NTSC) and Antenna (ATSC)

You must have two identical set-top boxes — such as two digital cable receivers, two satellite receivers, or two cable TV boxes (sold separately) — from the same TV source and the HP Digital Entertainment Center dual-tuner option (select models only) to set this up. This configuration will allow you to watch live TV on one channel and record another channel at the same time.



Connect the NTSC TV signal source from each set-top box or digital cable receiver into each of the HP Digital Entertainment Center tuner's TV Source 1 and TV Source 2.

If you are using two matching set-top cable boxes, with S-video or composite video output, do the following to connect two tuners and a HDTV ATSC input to your HP Digital Entertainment Center:

1 Make sure that:

- **Cable TV box:** A coaxial cable connector from your cable source (wall) is plugged into a cable splitter (provided), then into each cable set-top box In connector. This setup is similar to the illustration "TV signal source — two digital cable boxes (NTSC)" on page 92.
- **Digital cable receiver:** A coaxial cable connector from two cable sources (wall) is plugged into each digital cable receiver IN connector. See "TV signal source — two digital cable boxes (NTSC)" on page 92.

2 Connect a video cable for set-top box 1.



- a Choose a Video Out connector:
 - Video (composite) 
 - S-video 
- b Connect the video cable from the set-top box or digital cable receiver back panel video output connector.

- c Connect the video cable into the HP Digital Entertainment Center back panel TV Source 1 In connector.

3 Connect stereo audio cables for set-top box 1 (skip this step if using coaxial [RF]):

- a From the set-top box or digital cable receiver back Audio Out right (red) and Audio Out left (white) connectors.
- b Into the HP Digital Entertainment Center back panel TV Source 1 In Audio right (red) and Audio left (white) connectors.

4 Connect a video cable for set-top box 2:

- a Choose a video out connector; use the same type as set-top box 1:
 - Video (composite) 
 - S-video 
- b Connect the video cable from the set-top box or digital cable receiver back panel video output connector.
- c Connect the video cable into the HP Digital Entertainment Center back panel TV Source 2 In connector.

5 Connect stereo audio cables for set-top box 2 (skip this step if using coaxial [RF]):

- a From the set-top box or digital cable receiver back Audio Out right (red) and Audio Out left (white) connectors.
- b Into the HP Digital Entertainment Center back panel TV Source 2 In Audio right (red) and Audio left (white) connectors.

6 Connect the coaxial cable from the UHF/VHF antenna into the HDTV/SDTV Ant. In connector on the back of the HP Digital Entertainment Center.

7 Connect the set-top box 1 Infrared Transmitter cable (required for signal). See "Infrared Transmitter Connection" on page 97.

8 Connect the set-top box 2 Infrared Transmitter cable (required for signal). See "Infrared Transmitter Connection" on page 97.

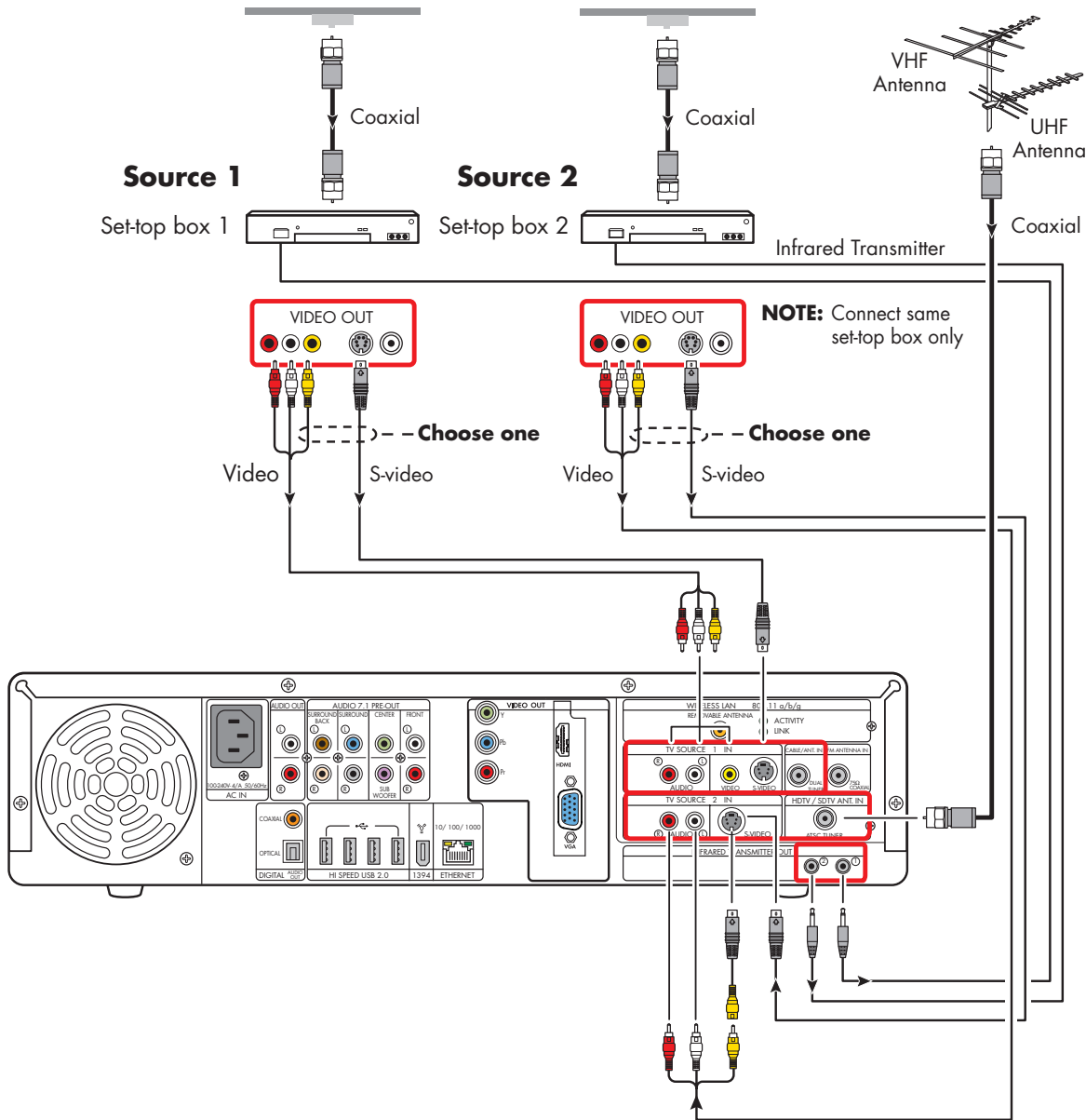

TV signal source – two cable boxes (NTSC) and ATSC UHF/VHF antenna

Cable Only (NTSC)

If you are using a standard cable without a set-top box or digital cable receiver, do the following to connect the NTSC-only TV signal source:

- 1 Plug the connector of a coaxial cable from your TV cable (wall) into the Cable/Ant connector on the back of the HP Digital Entertainment Center. This connection supplies the TV signal source for both TV tuners.
- 2 Turn the connector to tighten it.

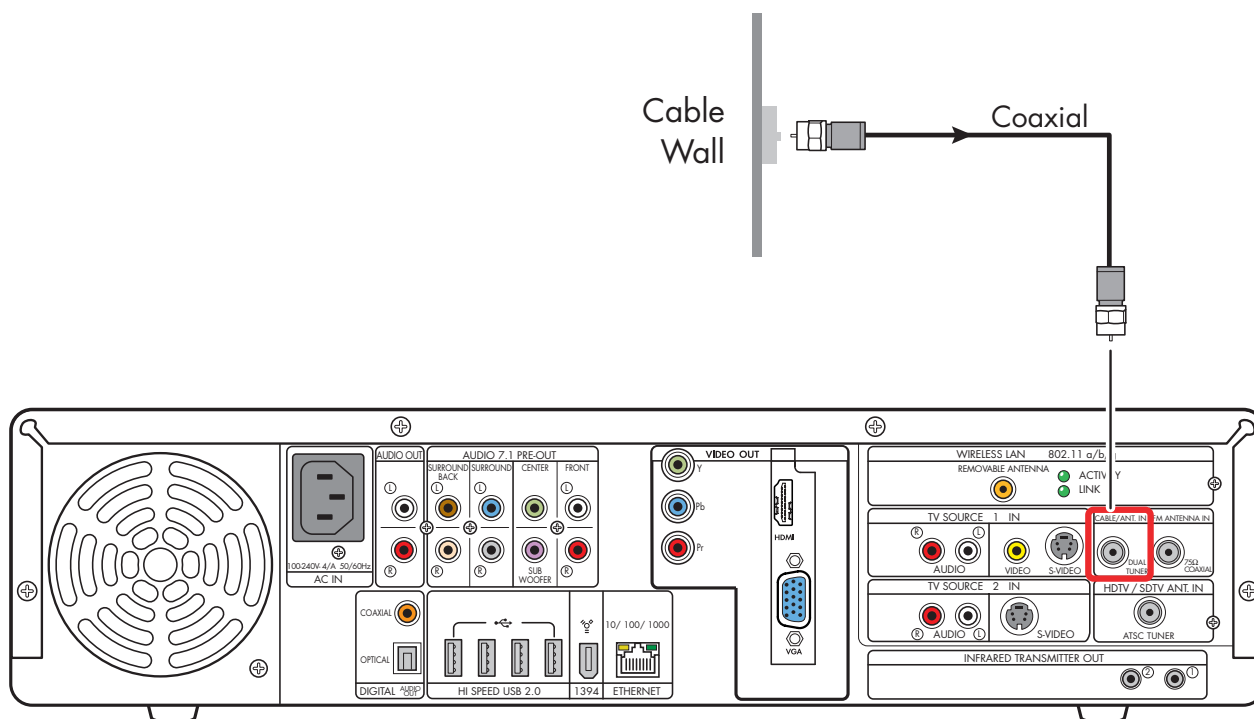



TV signal source (NTSC cable)

One Cable TV Box or Digital Cable Receiver (NTSC)

Connect the NTSC TV signal source from the standard cable TV set-top box or digital cable receiver (sold separately) into the HP Digital Entertainment Center.

If you are using a standard set-top box or digital cable receiver with S-video or composite video output, do the following:

- 1 Make sure that a coaxial cable connector from your cable TV source (wall) is plugged into the set-top box or digital cable receiver In connector.
- 2 Connect a video cable:
 - a Choose a video out connector:
 - Coaxial (RF) 
 - Video (composite) 
 - S-video 
 - b Connect the video cable from the set-top box or digital cable receiver back panel Video Output connector.
 - c Connect the video cable into the HP Digital Entertainment Center back panel TV Source 1 In connector.
- 3 Connect stereo audio cables (skip this step if using coaxial [RF]):
 - a From the set-top box or digital cable receiver back panel Audio Out right (red) and Audio Out left (white) connectors.
 - b Into the HP Digital Entertainment Center back panel TV Source 1 In Audio right (red) and Audio left (white) connectors.
- 4 Connect the set-top box Infrared Transmitter cable (required for signal). See "Infrared Transmitter Connection" on page 97.

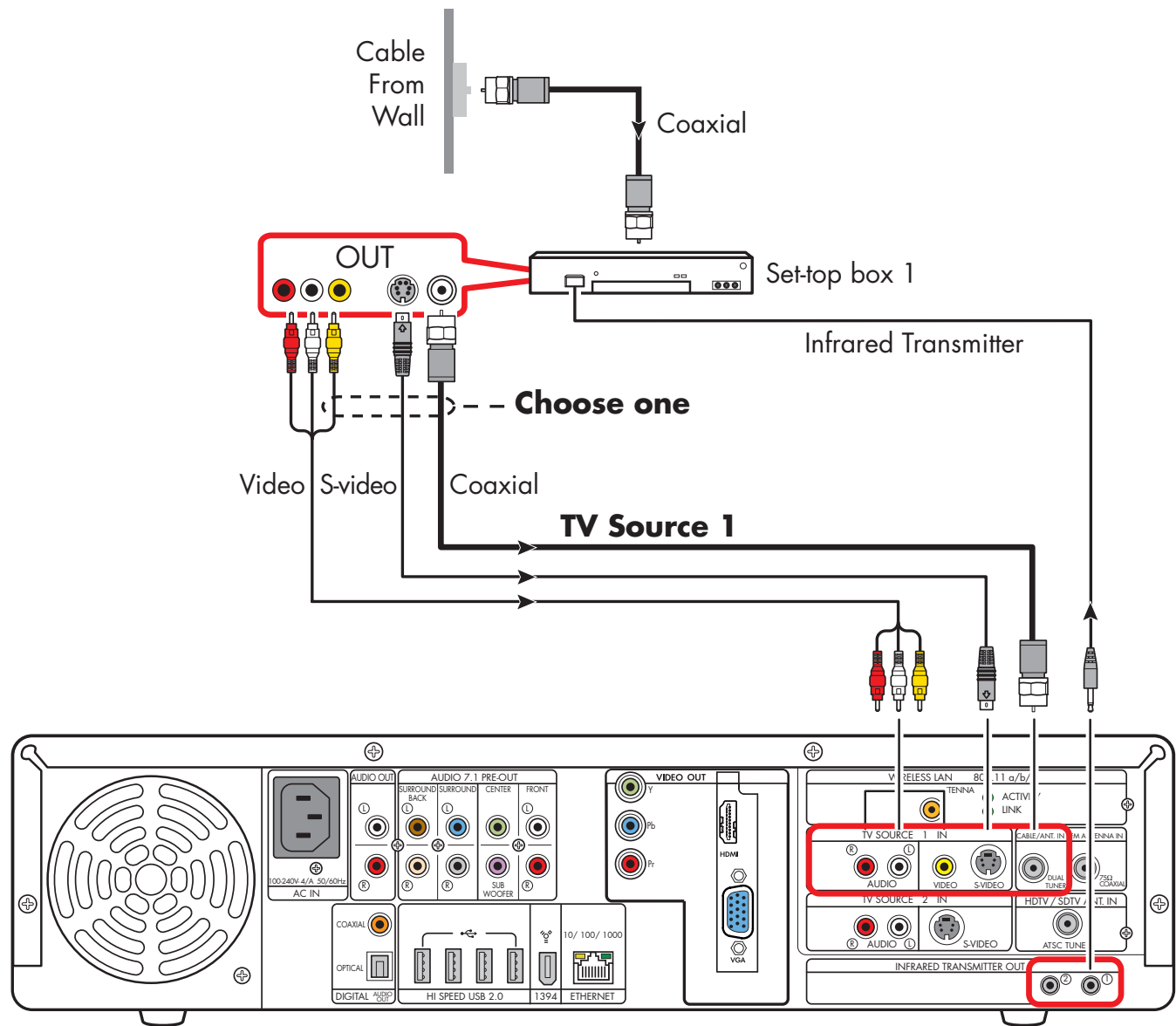

TV signal source – one cable TV or digital cable box (NTSC)

Two Cable TV Boxes, or Two Digital Cable Receivers

You must have two identical set-top boxes, such as two digital cable receivers or two cable TV boxes (sold separately), from the same TV source and the HP Digital Entertainment Center dual-tuner option (select models only) to set this up. This configuration will allow you to watch live TV on one channel and record another channel at the same time.



Connect the TV signal source from each set-top box or digital cable receiver into each of the HP Digital Entertainment Center tuner's TV Source 1 and TV Source 2.

If you are using two matching set-top cable boxes or digital cable receivers with S-video or composite video output, do the following:

1 Make sure that:

- **Cable TV box:** A coaxial cable connector from your cable source (wall) is plugged into a cable splitter (provided), then into each cable set-top box In connector. This setup is similar to the illustration See "TV signal source — two digital cable boxes (NTSC)" on page 92.
- **Digital cable receiver:** A coaxial cable connector from two cable sources (wall) is plugged into each digital cable receiver IN connector. See "TV signal source — two digital cable boxes (NTSC)" on page 92.

2 Connect a video cable for set-top box 1.

- a Choose a Video Out connector:
 - Video (composite) 
 - S-video 
- b Connect the video cable from the set-top box or digital cable receiver back panel video output connector.

- c Connect the video cable into the HP Digital Entertainment Center back panel TV Source 1 In connector.

3 Connect stereo audio cables for set-top box 1 (skip this step if using coaxial [RF]):

- a From the set-top box or digital cable receiver back Audio Out right (red) and Audio Out left (white) connectors.
- b Into the HP Digital Entertainment Center back panel TV Source 1 In Audio right (red) and Audio left (white) connectors.

4 Connect a video cable for set-top box 2:

- a Choose a video out connector; use the same type as set-top box 1:

- Video (composite) 

- S-video 

- b Connect the video cable from the set-top box or digital cable receiver back panel video output connector.

- c Connect the video cable into the HP Digital Entertainment Center back panel TV Source 2 In connector.

5 Connect stereo audio cables for set-top box 2 (skip this step if using coaxial [RF]):

- a From the set-top box or digital cable receiver back Audio Out right (red) and Audio Out left (white) connectors.
- b Into the HP Digital Entertainment Center back panel TV Source 2 In Audio right (red) and Audio left (white) connectors.

6 Connect the set-top box 1 Infrared Transmitter cable (required for signal). See "Infrared Transmitter Connection" on page 97.

7 Connect the set-top box 2 Infrared Transmitter cable (required for signal). See "Infrared Transmitter Connection" on page 97.

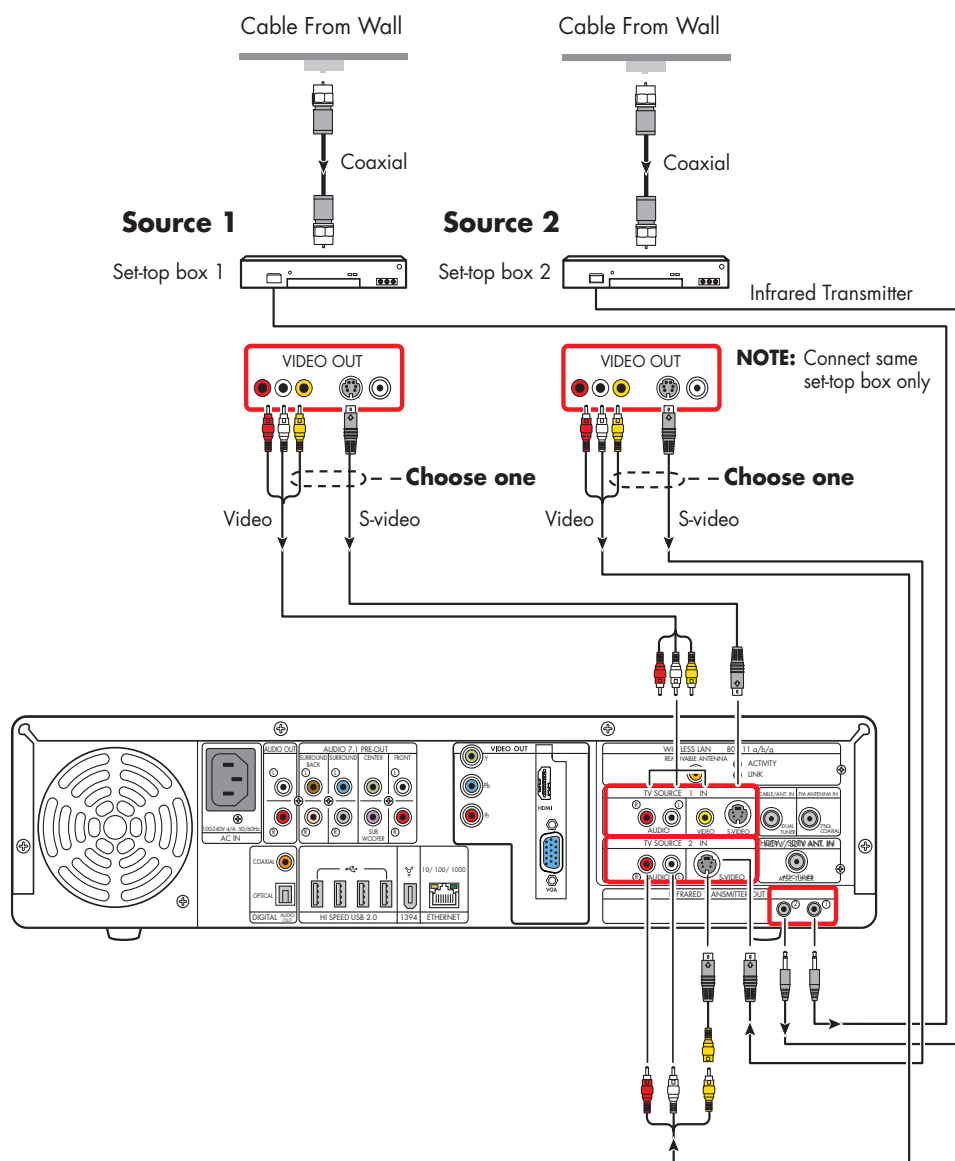

TV signal source – two digital cable boxes (NTSC)



Satellite Connection

(Location, availability, and number of connectors may vary.)

One Satellite Receiver (NTSC)

Connect the TV signal source from the satellite receiver into the HP Digital Entertainment Center.

If you are using a satellite receiver (sold separately) with S-video or composite video output, do the following:

- 1** Make sure that a coaxial cable connector from your dish source is plugged into the satellite receiver In connector.
- 2** Connect a video cable.
 - a** Choose a Video Out connector:
 - Coaxial (RF) 
 - Video (composite) 
 - S-video 
 - b** Connect the video cable from the satellite receiver back panel video output connector.
 - c** Connect the video cable into the HP Digital Entertainment Center back panel TV Source 1 In connector.
- 3** Connect stereo audio cables (skip this step if using coaxial [RF]):
 - a** From the satellite receiver back panel Audio Out right (red) connector and Audio Out left (white) connectors.
 - b** Into the HP Digital Entertainment Center back panel TV Source 1 In Audio right (red) and Audio left (white) connectors.
- 4** Connect the satellite receiver Infrared Transmitter cable (required for signal). See "Infrared Transmitter Connection" on page 97.

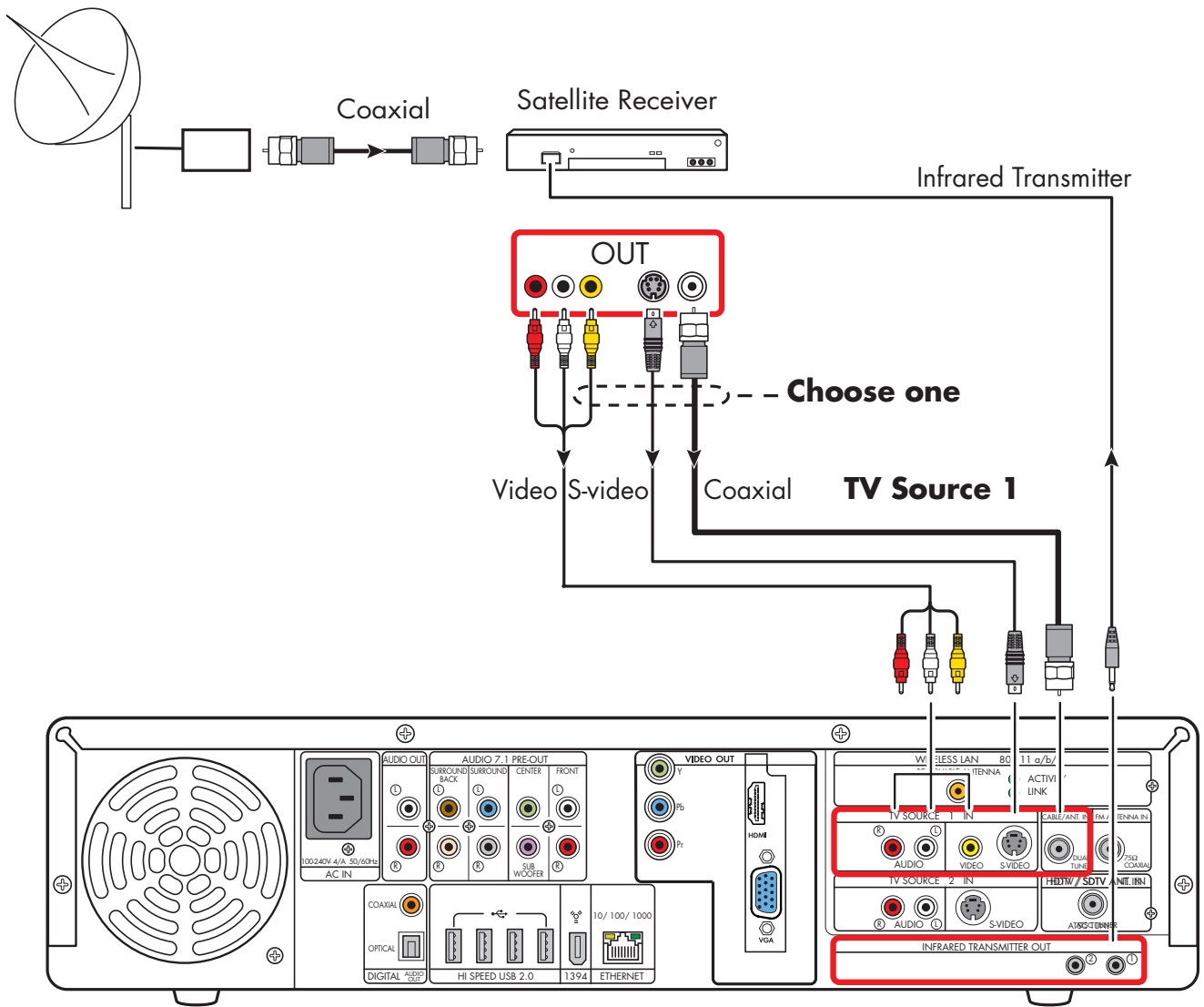





TV signal source – one satellite receiver (NTSC)

Two Satellite Receivers (NTSC)

You must have two identical satellite receivers from the same source and the HP Digital Entertainment Center dual-tuner option (select models only) to set this up. This configuration will allow you to watch live TV on one channel and record another channel at the same time.

Connect the TV signal source from each satellite receiver into each HP Digital Entertainment Center tuner.

If you are using two matching satellite receivers with S-video or composite video output, do the following:

- 1** Make sure that a coaxial cable connector from your dish source is plugged into two cable outputs, and each satellite receiver In connector.
- 2** Connect a video cable for satellite receiver 1:
 - a** Choose a Video Out connector:
 - Video (composite) 
 - S-video 
 - b** Connect the video cable from the satellite receiver back panel video output connector.
 - c** Connect the video cable into the HP Digital Entertainment Center back panel TV Source 1 In connector.
- 3** Connect stereo audio cables for satellite receiver 1 (skip this step if using coaxial [RF]):
 - a** From the satellite receiver back panel Audio Out right (red) connector and the Audio Out left (white) connectors.
 - b** Into the HP Digital Entertainment Center back panel TV Source 1 In Audio right (red) and Audio left (white) connectors.
- 4** Connect a video cable for satellite receiver 2:
 - a** Choose a video out connector, use the same type as satellite receiver 1:
 - Video (composite) 
 - S-video 
 - b** Connect the video cable from the satellite receiver back panel video output connector.
 - c** Connect the video cable into the HP Digital Entertainment Center back panel TV Source 2 In connector.
- 5** Connect stereo audio cables for satellite receiver 2 (skip this step if using coaxial [RF]):
 - a** From the satellite receiver back panel Audio Out right (red) connector and Audio Out left (white) connectors.
 - b** Into the HP Digital Entertainment Center back panel TV Source 2 In Audio right (red) and Audio left (white) connectors.

6 Connect the satellite receiver 1 Infrared Transmitter cable (required for signal). See "Infrared Transmitter Connection" on page 97.

7 Connect the satellite receiver 2 Infrared Transmitter cable (required for signal). See "Infrared Transmitter Connection" on page 97.

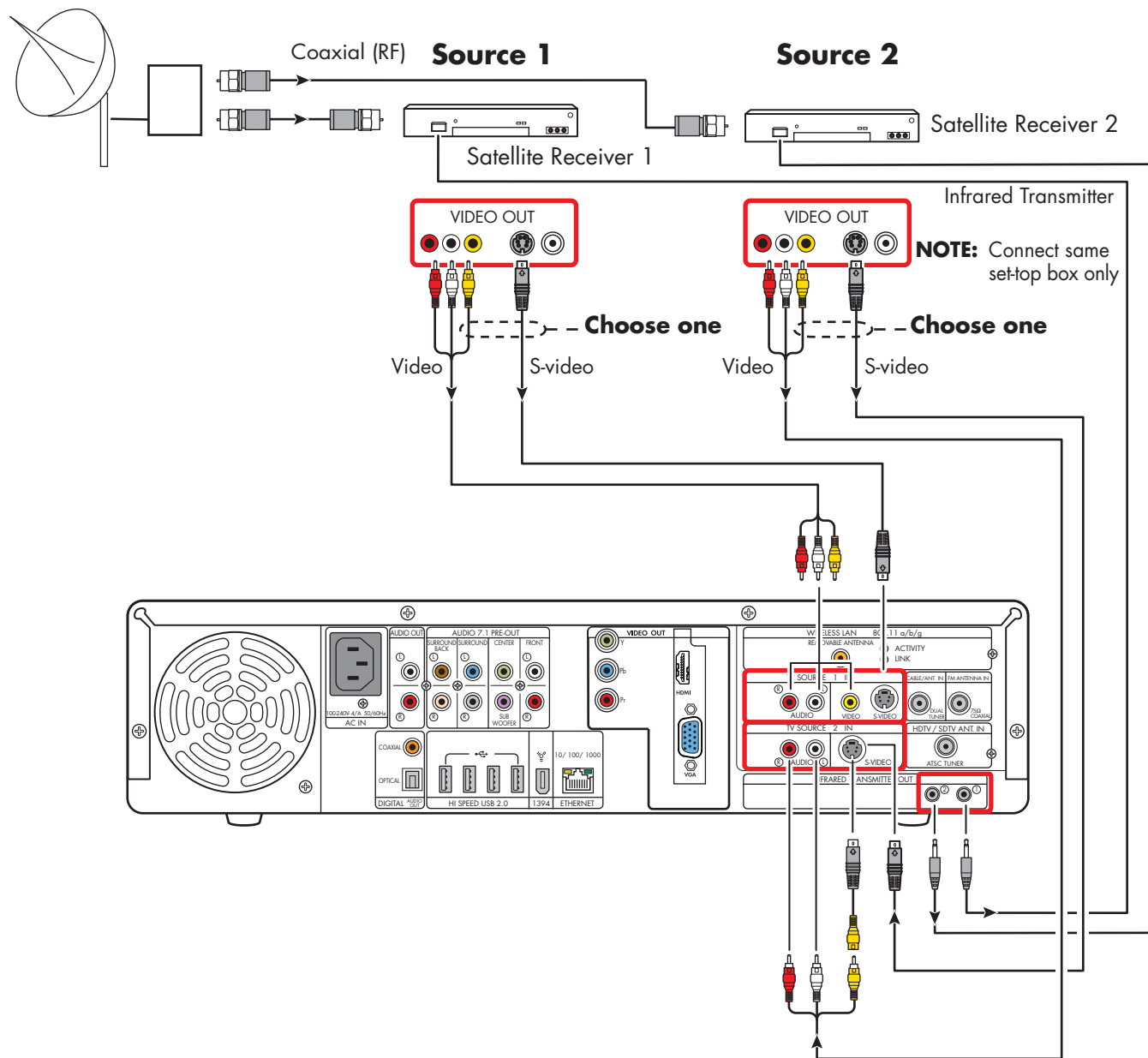

TV signal source – two satellite receivers (NTSC) (select models only)

Infrared Transmitter Connection

Infrared Transmitter Overview

The HP Digital Entertainment Center includes Infrared Transmitters that make it easy to control one or two set-top boxes. If you connect a set-top box such as a digital cable box or a satellite receiver to the HP Digital Entertainment Center, then you must also use the Infrared (IR) Transmitter control cable.

The **remote control** sends commands to the HP Digital Entertainment Center, which relays these commands via the Infrared Transmitter control cables to the cable box or satellite receiver.

The **Infrared Transmitter** control cable has a sender tip (IR Blaster) that attaches to the front of the cable box (or other set-top box) and plugs into the back of the HP Digital Entertainment Center.

You must carefully position the Infrared Transmitter control cable sender tip on to the set-top box front panel to ensure the set-top box receives the signal.

The **remote receiver** is on the front of the cable box, digital cable box, or satellite receiver. It receives Infrared commands from your cable box remote control or from the Infrared Transmitter cable. The remote receiver is sometimes hidden behind a panel of dark, transparent plastic. You can use a flashlight to locate it. For more information about the remote receiver, refer to the documentation for your cable box, digital cable box, or satellite receiver.



The Infrared Transmitter connection is required for a signal with a set-top box.

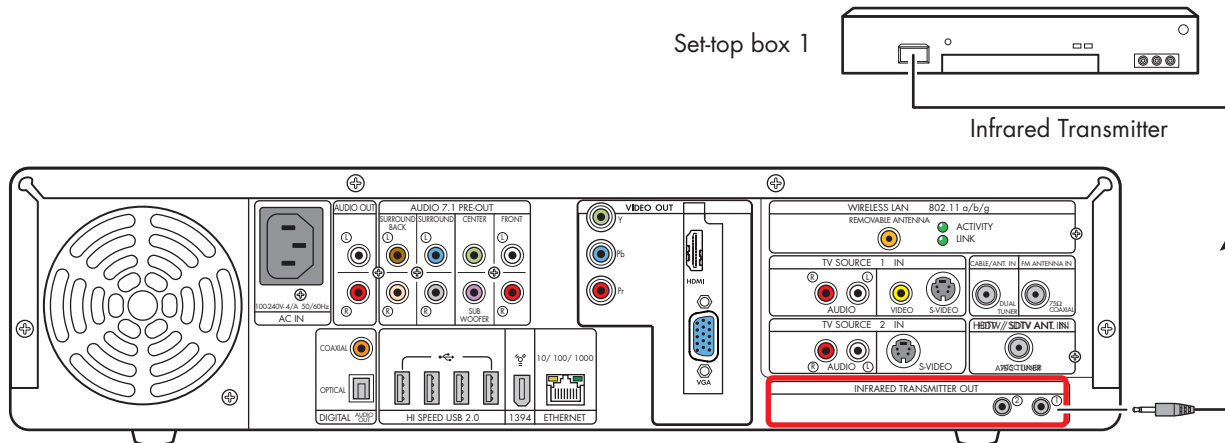

Infrared Transmitter connection (one set-top box)

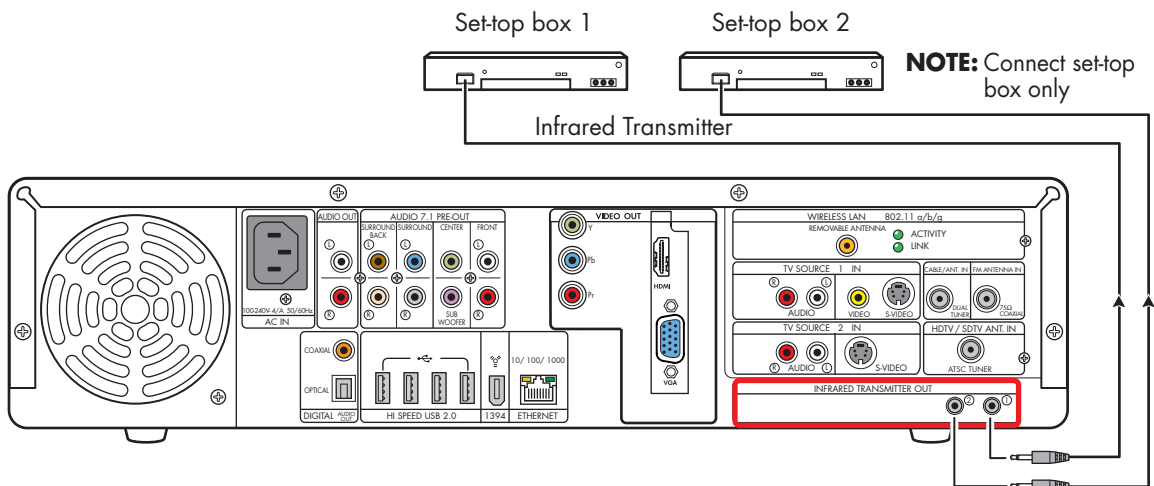

Infrared Transmitter connection (two set-top boxes; select models only)

Infrared Transmitter Installation

If you have a cable TV receiver, satellite receiver, or other set-top box that controls your TV signal, connect the Infrared Transmitter sensor:

- 1** Route the Infrared Transmitter cable from the back of the HP Digital Entertainment Center to the cable TV, digital cable, or satellite receiver set-top box.
- 2** Locate the IR remote receiver area on the front of the set-top box. This is where you aim the set-top box remote control to change channels, change the sound level, and so on.
 - The IR remote receiver area may be behind an obvious window on the set-top box.
 - Use the set-top box remote control to locate its IR remote receiver area: Hold the remote control very close (within 1 inch/2.54 centimeters) and press a remote button to change the channel or power off the box. As you push a button, gradually move the remote control across the front of the box until the box responds.
 - Hold a flashlight close to the front of the set-top box, and look for a transparent window with a small box inside. Test the area by holding the box remote close to the window and pushing a button until the box responds.
- 3** Use a piece of tape to temporarily hold the Infrared Transmitter cable tip over the set-top box IR remote receiver area while you test the function.
- 4** Plug the Infrared Transmitter cable into the Infrared Transmitter connector on the back of the HP Digital Entertainment Center.
- 5** Test the operation by pointing the HP Digital Entertainment Center remote control at the HP Digital Entertainment Center IR receiver and pressing a channel button. (Be sure you use the HP Digital Entertainment Center remote and point it at the HP Digital Entertainment Center.)
- 6** For permanent attachment, remove the paper from the Infrared Transmitter cable tip, and press the tip onto the IR remote receiver area on the set-top box.
- 7** Repeat these steps for the second set-top box.

The following illustration shows the Infrared Transmitter installation.

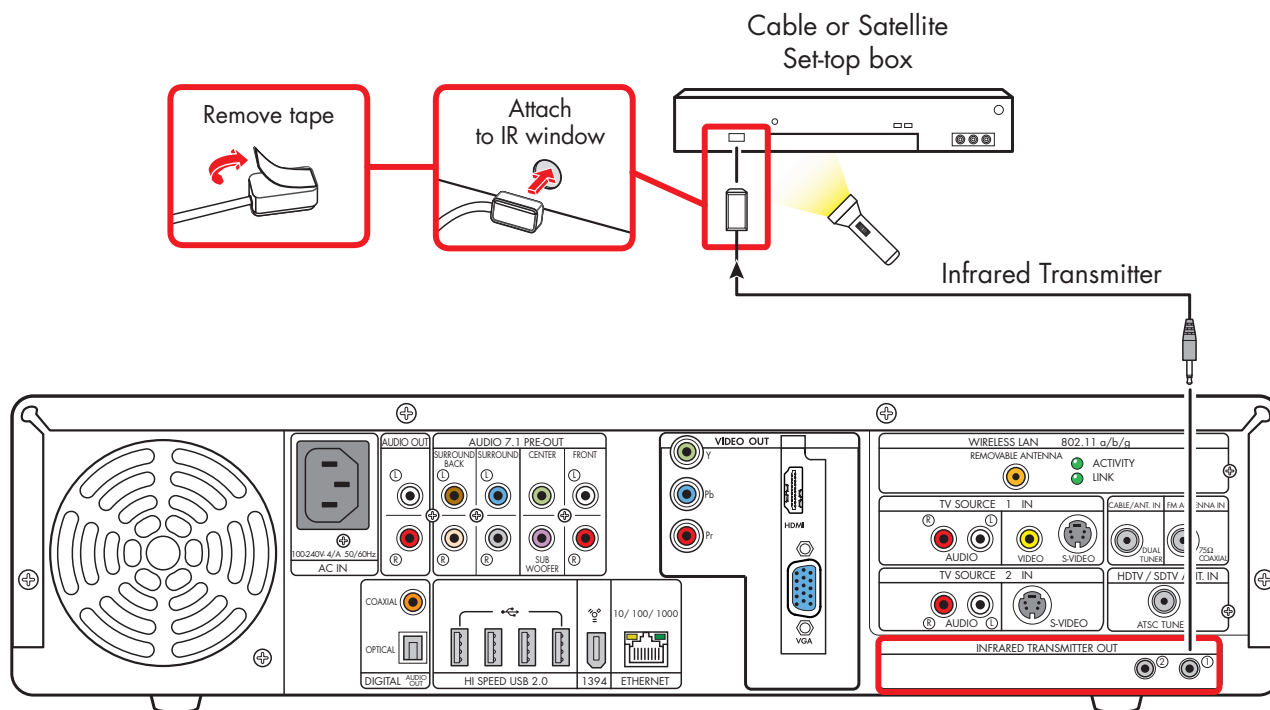

Infrared transmitter to cable, digital cable receiver, or satellite receiver set-top box

Connecting Video Equipment

This chapter describes how to connect video playback and recording equipment to the HP Digital Entertainment Center. Equipment includes VCRs and camcorders. This chapter also includes the most typical, and some advanced, options.

The HP Digital Entertainment Center supports many different video input and audio/video output options and connections. Your system may have different components.

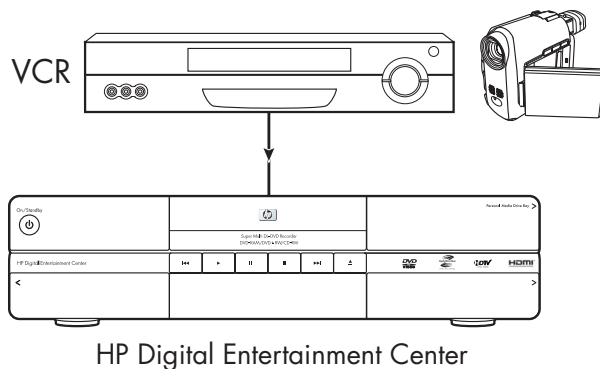

Chapter Contents:

"Video Equipment Overview" on page 102

"Typical Video Equipment Connections" on page 104

"VCR Connection" on page 105

"Video Camera Connection" on page 109







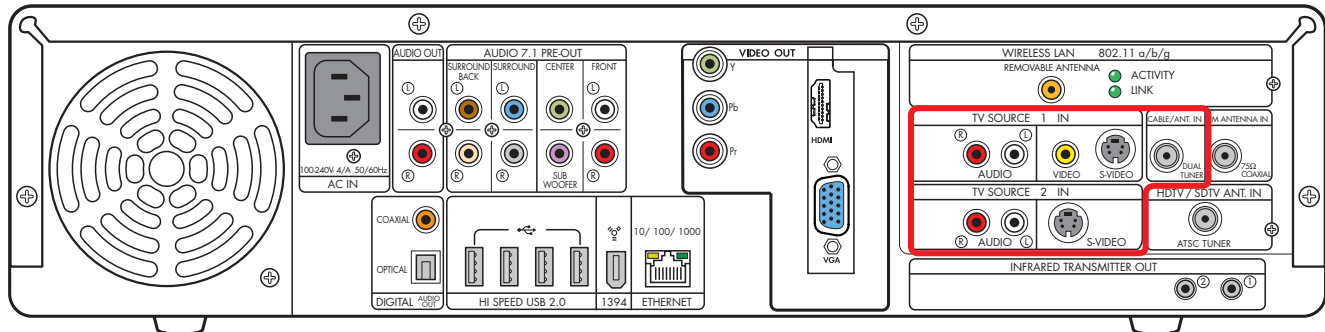

A stable image on your TV/display may cause screen burn-in if left on for a long time. Use a screen-saver and low contrast colors for desktop background images to reduce burn-in.

Video Equipment Overview

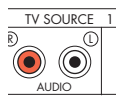
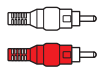
Connectors

(Location, availability, and number of connectors may vary.)

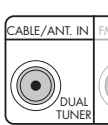
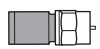

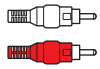
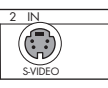
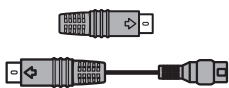
Item	Connector	Type	Color	Cable
	Audio: TV Source 1 In	RCA jacks	White: Left Red: Right	
	Video: TV Source 1 In	RCA jack	Yellow	
	S-video TV: Source 1 In	Analog: Y/C video 4-pin	Black	
	Cable/Antenna In With internal splitter to dual-tuners	Coaxial	Silver	
	Audio: TV Source 2 In	RCA jacks	White: Left Red: Right	
	S-video TV Source 2 In (Select models only) Use S-video to composite adapter to connect composite video	Analog: Y/C video 4-pin (optional)	Black	

Additional cables and the S-video to composite adapter are sold separately.

Video Equipment Connection Overview

Standard video equipment has one or more of the following video out connectors and cables:

- Coaxial (RF)
- Composite
- S-video



The type of video cable you need depends on your video equipment:

- If your video equipment has an S-video jack, you need an S-video cable. An S-video cable provides separate color and black-and-white image signals and delivers a sharper image than a composite video cable does.
- If your video equipment has a composite video jack, you need a composite video cable.

You may need other or additional cables, depending on your video equipment.



If your video equipment has multiple input and output connections, then it has front panel input and output switches.

You must select the correct input and output from the video equipment front panel or remote control to hear sound and see video.

You can also connect your digital video camera to work with the HP Digital Entertainment Center through FireWire (IEEE 1394) connectors.



DVD player

The HP Digital Entertainment Center has a built-in DVD player/recorder.



The HP Digital Entertainment Center is intended for legal purposes only and not designed to record retail movie title DVDs.



Connect video game boxes directly to your TV.

Typical Video Equipment Connections

This section describes how to connect the HP Digital Entertainment Center to an existing setup of your video equipment.

These are only suggested configurations. Your system may be different.

Select the configuration that most closely matches your home system:

TV source type	Display/video configuration	See:
VCR	VCR direct to HP Digital Entertainment Center	"VCR Direct In Connection" on page 105
	From HP Digital Entertainment Center to VCR to TV	"Wall to VCR to TV Using Coaxial Cable" on page 106
Camcorder	Digital	"Connecting a Digital Video Camcorder" on page 109
	Analog	"Connecting an Analog Camcorder" on page 112

Then see:
"Connecting the Network" on page 113
"Initial Configuration" on page 127

VCR Connection

VCR Direct In Connection

You can connect a VCR to record your tapes to the HP Digital Entertainment Center hard disk drive.



The HP Digital Entertainment Center is intended for legal purposes only. Some retail VHS tapes have content protection measures that do not allow recording.

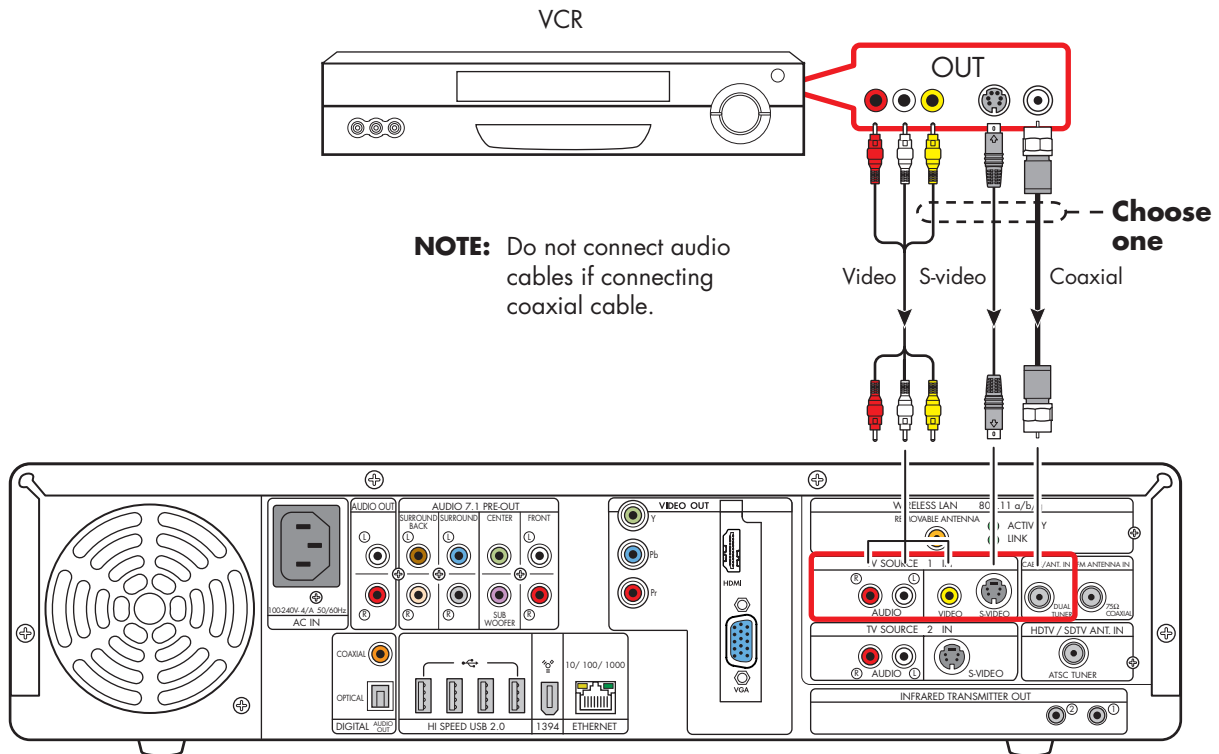

VCR connection

Wall to VCR to TV Using Coaxial Cable

- 1 Remove the coaxial cable at the input to the VCR.
- 2 Connect the coaxial cable to the input of a signal splitter (available at electronics stores).
- 3 Connect two coaxial cables to the splitter outputs.
- 4 Connect one coaxial cable to the input of the VCR.
- 5 Connect one coaxial cable to the TV Source 1 in back of the HP Digital Entertainment Center.
- 6 Connect a coaxial cable from the VCR out to one of the TV inputs. Reserve an input connection on the TV for the HP Digital Entertainment Center.

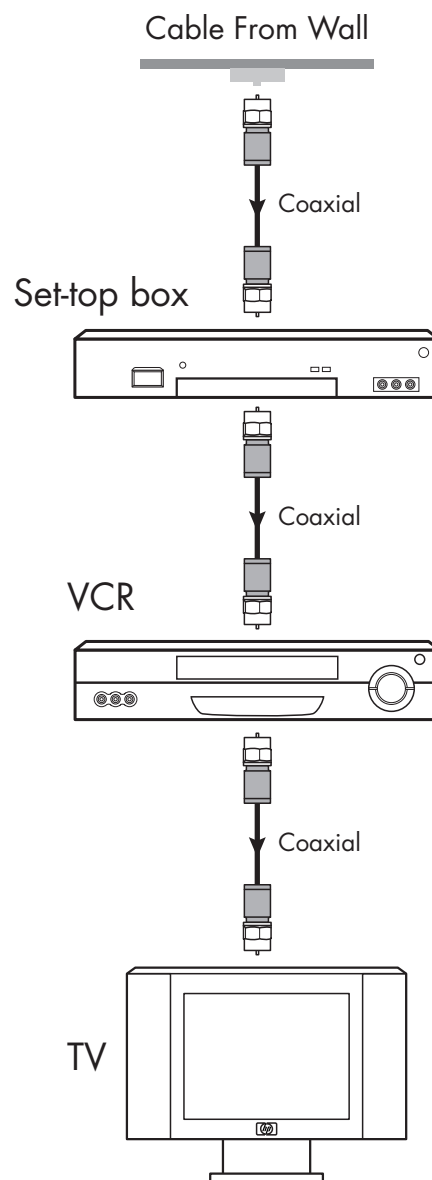
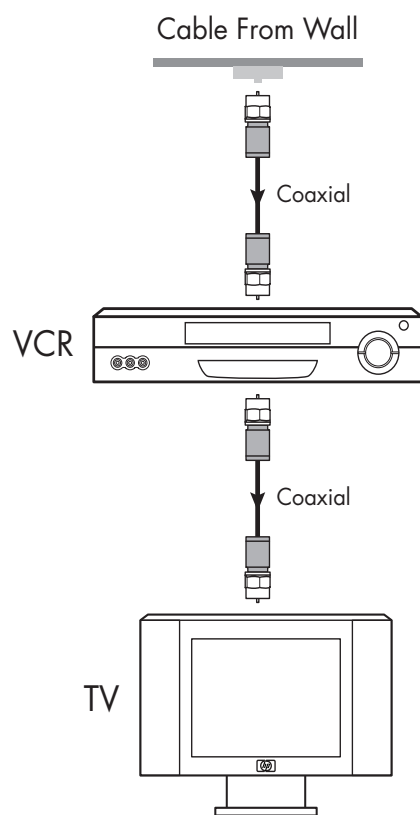

Existing setups with and without set-top box

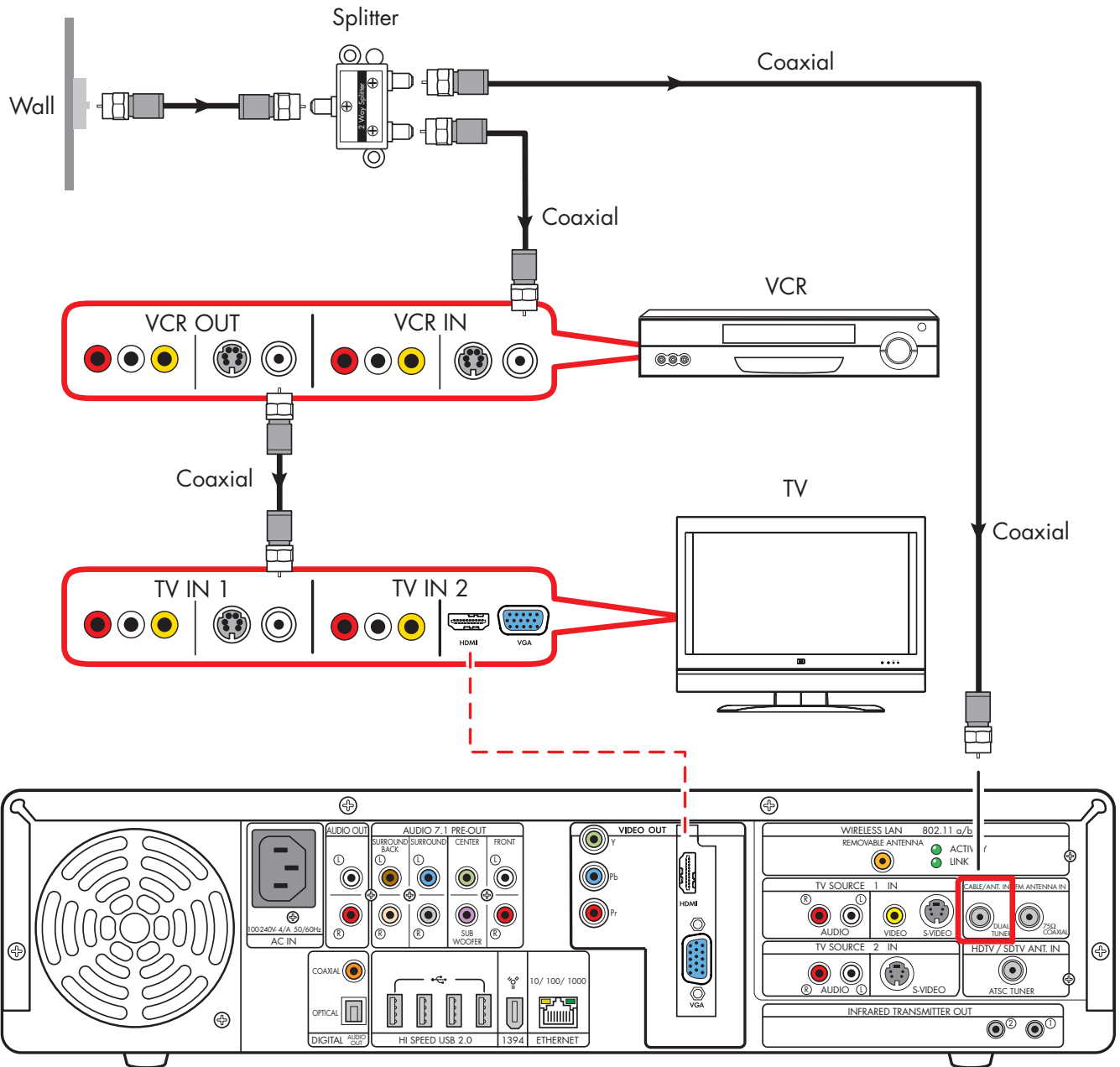

Connecting Video Equipment

Wall to VCR to TV using coaxial cable (Add the HP Digital Entertainment Center with a splitter)

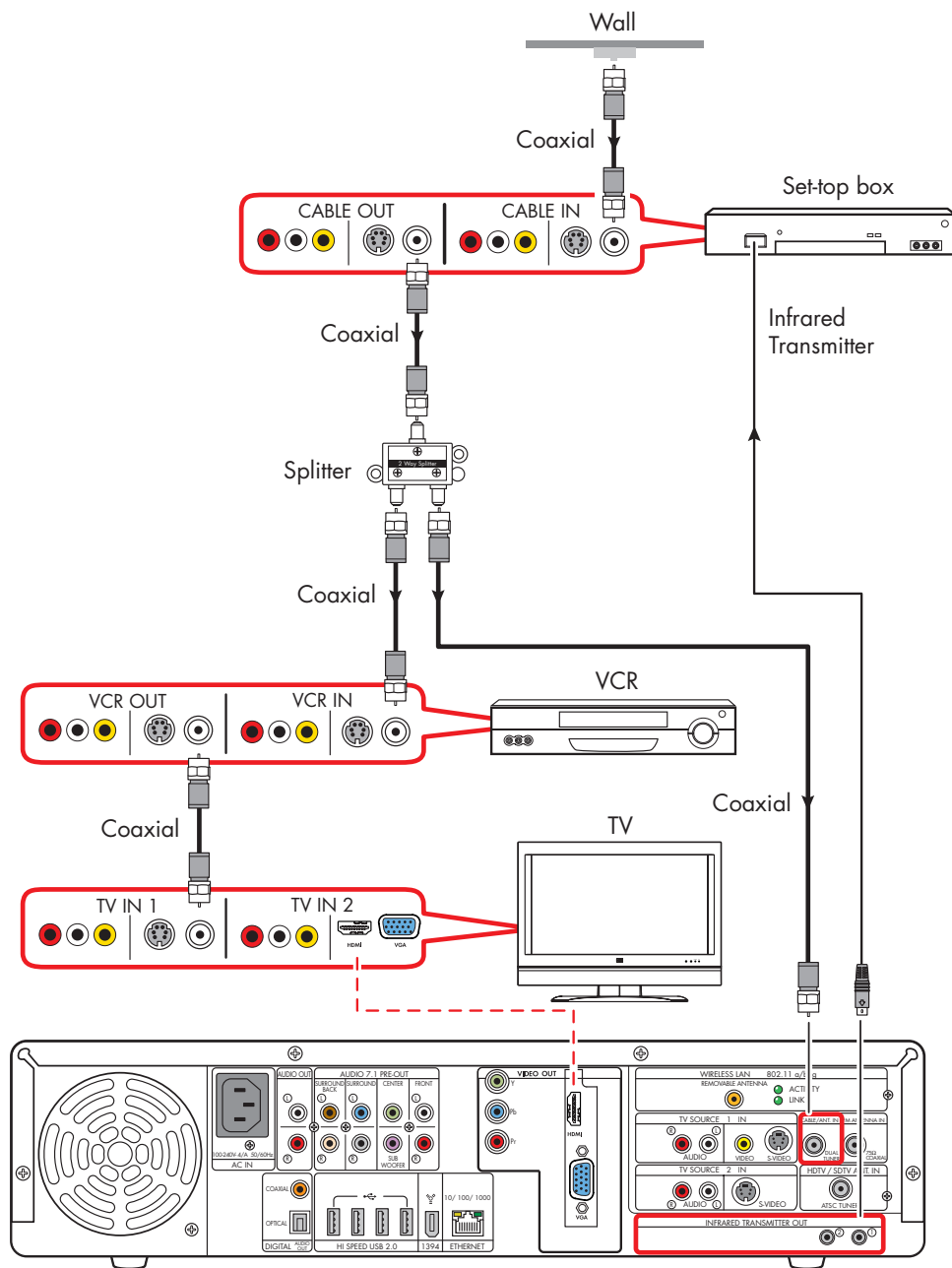

Wall to set-top box VCR to TV using coaxial cable (add with a splitter)

Video Camera Connection

Refer to the HP support Web site for detailed information on advanced video setup. Go to <http://www.hp.com/support> and select your model number. See "HP Web Site Support" on page 171.

Connecting a Digital Video Camcorder

Connectors:

Use the 4-pin FireWire (IEEE 1394) connector on the front or 6-pin FireWire (IEEE 1394) connector on the back panel of the HP Digital Entertainment Center to connect a digital video camera. This connector is bi-directional.

Some cameras use a USB connector. See the documentation that came with your digital video camera. See "USB Device Connection" on page 121.

Equipment:

Most digital video cameras use either a 4-pin to 4-pin or a 4-pin to 6-pin FireWire (IEEE 1394) video camera transfer cable. A 4-pin to 4-pin FireWire (IEEE 1394) cable to use the 4-pin FireWire (IEEE 1394) connector on the HP Digital Entertainment Center front panel is sold separately.

Procedure:

The following instructions apply only to digital video cameras. See "Connecting an Analog Camcorder" on page 112 for analog video cameras.

If a Digital Video Device Auto Play window appears when you connect your camera, click Cancel.

To connect a digital video camera:

- 1 Turn on the HP Digital Entertainment Center, and wait for the desktop to appear. See "Initial Configuration" on page 127.
- 2 Turn on the digital video camera.
- 3 Connect the video camera transfer cable from the camera to a FireWire (IEEE 1394) connector on the front (4-pin) or back (6-pin) of the HP Digital Entertainment Center.
- 4 A *Found New Hardware* message appears. Wait two or three minutes for the system to make the necessary settings for the new device. When installation is complete, a message appears telling you the camera is ready to use.

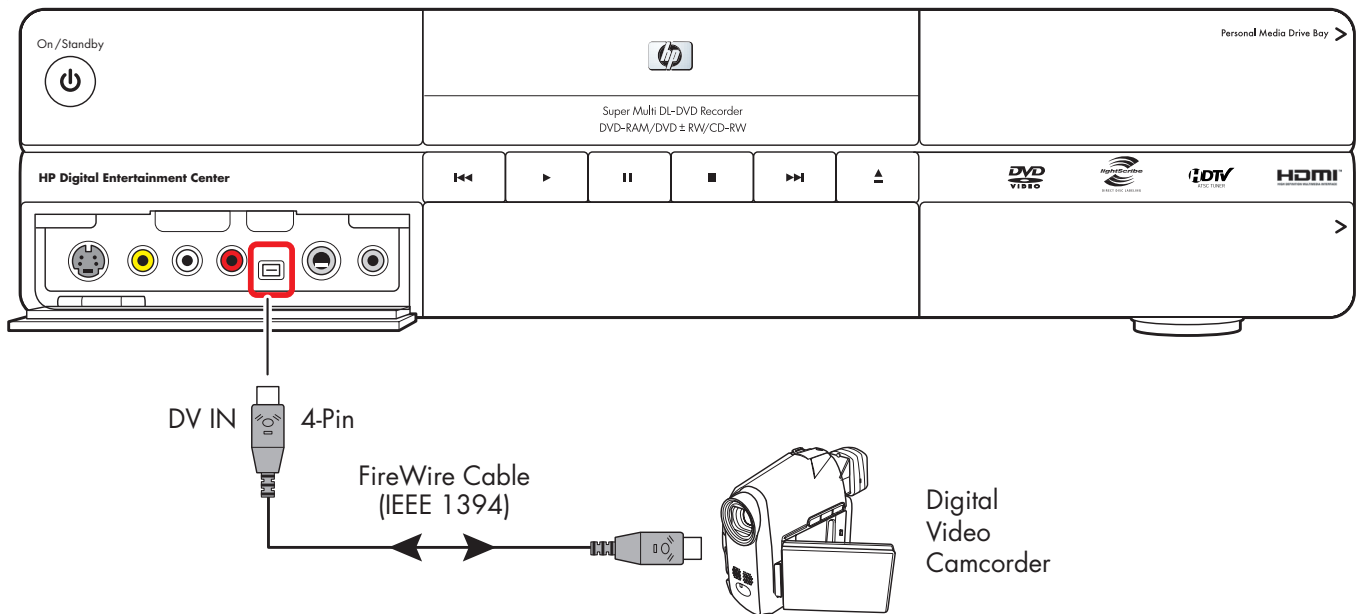

Connect a digital video camcorder (front panel)

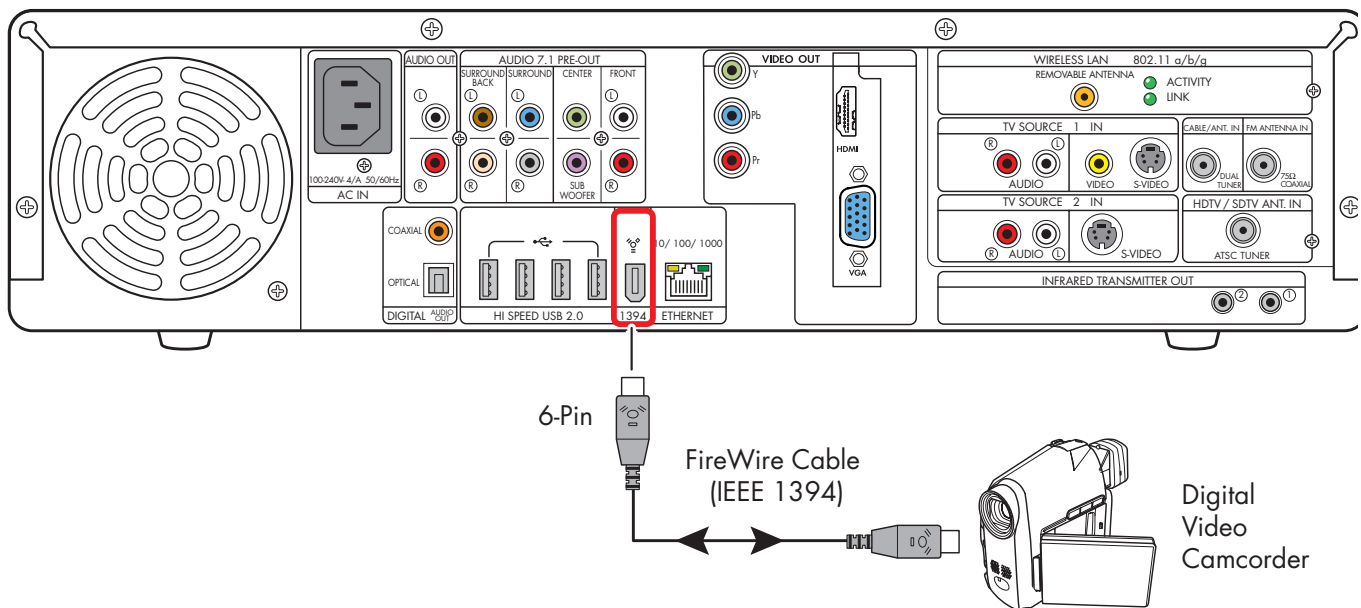

Connect a digital video camcorder (back panel)

Recognizing the digital video camcorder

If the HP Digital Entertainment Center does not recognize your digital video camera:

- 1 Start up the HP Digital Entertainment Center. See "Initial Configuration" on page 127.
 - 2 Click **Start**, and then click **Control Panel**.
 - 3 Click **Performance and Maintenance**, if available, and then double-click the **System** icon.
 - 4 Click the **Hardware** tab, and then click the **Device Manager** button.
- 5 Click the plus sign (+) next to imaging devices. If the name of the camera appears under imaging devices the device is ready. If the name is not there, try the following:
 - Click **Action**, and then **Scan for hardware changes**. Look in Device Manager for a new addition under imaging devices.
 - Unplug the video camera's transfer cable from the HP Digital Entertainment Center. Power cycle the camera and plug it back in. Look in Device Manager for a new addition under imaging devices.

For more information about viewing your pictures or digital video files in Media Center or copying your pictures to CD, see the *HP Digital Entertainment Center Software Guide*.

Connecting an Analog Camcorder

Connecting an analog camera for video input (capture)

Connectors:

When connecting an analog video camera for input to the HP Digital Entertainment Center, use the Video and Audio In connectors on the front of the HP Digital Entertainment Center.

Procedure:

The following instructions can also be used to connect digital cameras with analog outputs.

See the documentation that came with your video camera.

To connect an analog video camera:

- 1 Turn on the HP Digital Entertainment Center, and wait for the desktop to appear. See "Initial Configuration" on page 127.
- 2 Connect the video camera transfer cable from the camera to the S-video connector or to the composite and audio connectors on the front of the HP Digital Entertainment Center.
- 3 Turn on the camera and use InterVideo WinDVD Creator to capture your video recording.

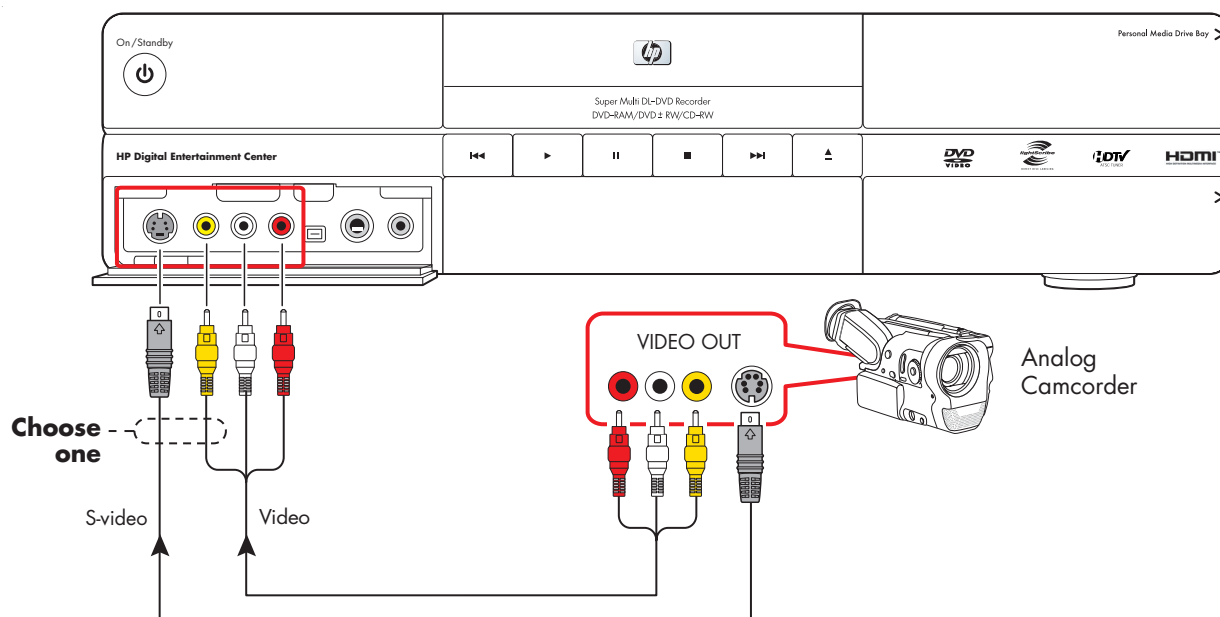

Connect an analog video camera for source input

Connecting the Network

Your system must have working broadband Internet to operate properly.

The HP Digital Entertainment Center supports many different network options, connections, and configurations. You can connect your HP Digital Entertainment Center to a:

- Wireless 802.11 a/b/g network
- Wired Ethernet port 10/100/1000

You can connect your peripheral devices to work with the HP Digital Entertainment Center through USB or FireWire (IEEE 1394) connectors.

This chapter describes the most typical, and some advanced, options to connect your HP Digital Entertainment Center to the Internet, to a network, and to peripheral devices. Your system may have different components.

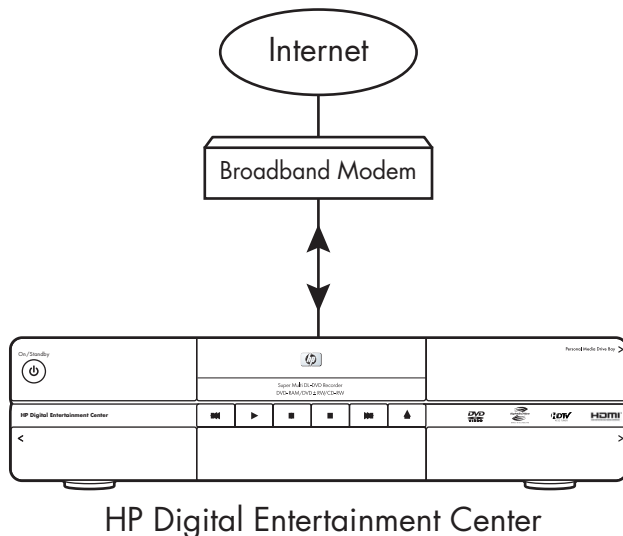

Chapter Contents:

"Peripheral Connection Overview" on page 114

"Typical Network Connections" on page 116

"Connecting the Wireless Network Antenna" on page 117

"Connecting a DSL/Cable Modem" on page 119

"Connecting Through a Router" on page 120

"USB Device Connection" on page 121

"Connecting an HP Personal Media Drive" on page 123



Peripheral devices are sold separately.



For additional information on connecting network equipment, refer to the *Start Here* booklet and the hardware and ISP (Internet Service Provider) documentation that came with your network.

Peripheral Connection Overview

Front Panel

(Location, availability, and number of connectors may vary.)

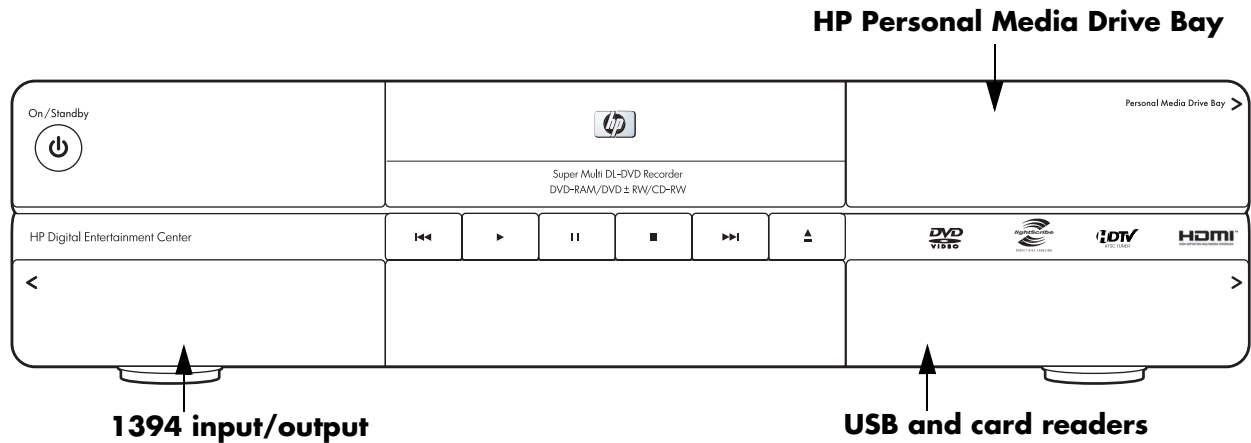







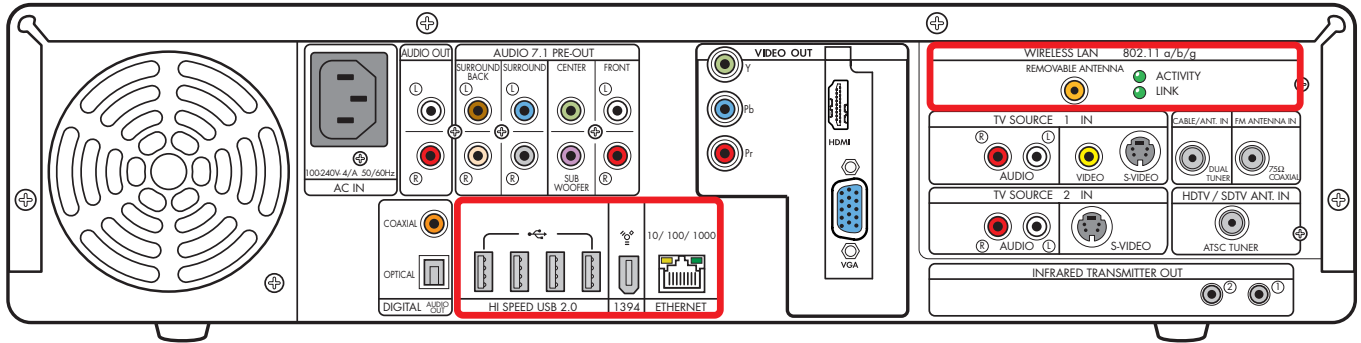

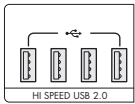
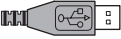
Connector	Name	Description
	<i>Behind Upper Right Door</i> HP Personal Media Drive Bay	Removable hard disk
	<i>Behind Lower Right Door</i> 9-in-1 Memory card readers SmartMedia/xD, MMC/SD, CompactFlash I/II, Microdrive, MS/MS-Pro USB 2.0 (2)	Card readers behind lower right door LED: Green (with media inserted) Off (no media inserted) See "Memory Card Reader" on page 5.
	<i>Behind Left Door</i> AV connectivity for capturing analog and digital video from camcorders.	<i>Front button and inputs — see below</i>
	FireWire (IEEE 1394)	FireWire (IEEE 1394), 4-pin DV input/output for digital video or removable hard disk drive

Back Panel

(Location, availability, and number of connectors may vary.)

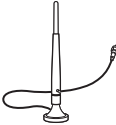

Connector	Name	Description	Cable
	USB 2.0	High-speed USB, 4 ports	
	FireWire (IEEE) 1394	FireWire (IEEE 1394), 6-pin DV input/output for hard disk drive	
	Ethernet	RJ-45 10/100/1000	
	Wireless LAN Removable Antenna	Coaxial wireless LAN 802.11 a/b/g	
	LEDs (2)	Activity: Blinks when transmitting/receiving data Link: Solid green when wireless LAN is enabled and connected. Blinks when wireless LAN is scanning.	

Typical Network Connections

This section describes how to connect the HP Digital Entertainment Center to the Internet, so you can download the Television Program Guide and surf the Web.

These are only suggested configurations. Your system may be different.

Select the configuration that most closely matches your home system:

Connection	Network configuration	See:
Internet Wireless or Ethernet (10BaseT) Or Fast Ethernet (100BaseT) Or Gigabit Ethernet (1000BaseT)	From an 802.11 a/b/g wireless network	"Connecting the Wireless Network Antenna" on page 117
	From a DSL modem or cable modem to a router	"Connecting Through a Router" on page 120
	From a DSL modem or cable modem	"Connecting a DSL/Cable Modem" on page 119

Then see:

"Initial Configuration" on page 127

Connecting the Wireless Network Antenna

You can connect the HP Digital Entertainment Center to a 802.11 a/b/g wireless network. The transceiver is built in to the HP Digital Entertainment Center. An external antenna is supplied with your system. You must connect this antenna to connect to the wireless network. You need an existing wireless LAN network with an Internet connection (please consult your ISP for further information).

Your HP Digital Entertainment Center connects with other wireless product(s) via 802.11 a/b/g technology. The 802.11 a/b/g wireless LAN function allows you to connect to your home network and other devices that are compatible with the 802.11 a/b/g wireless LAN. The wireless LAN connects to the Internet.

You can establish a wireless network using your HP Digital Entertainment Center as a wireless access point, or you can use your HP Digital Entertainment Center as a client if you already have a wireless network functioning. Refer to the *Quick Install Guide* and CD manual included in the accessory box to set up the HP Digital Entertainment Center as a wireless access point.

A wireless access point and a wireless router are required and sold separately. Wireless Internet use requires a separately purchased Internet service contract.

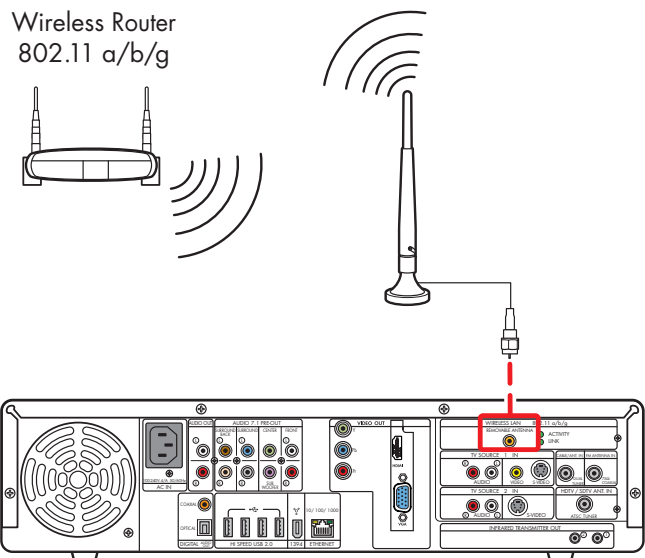

Wireless router Internet connection

To connect a Wi-Fi antenna to the HP Digital Entertainment Center:

1 Screw the antenna into the Wireless LAN Removable Antenna connector on to the back panel, as shown in the following illustration:

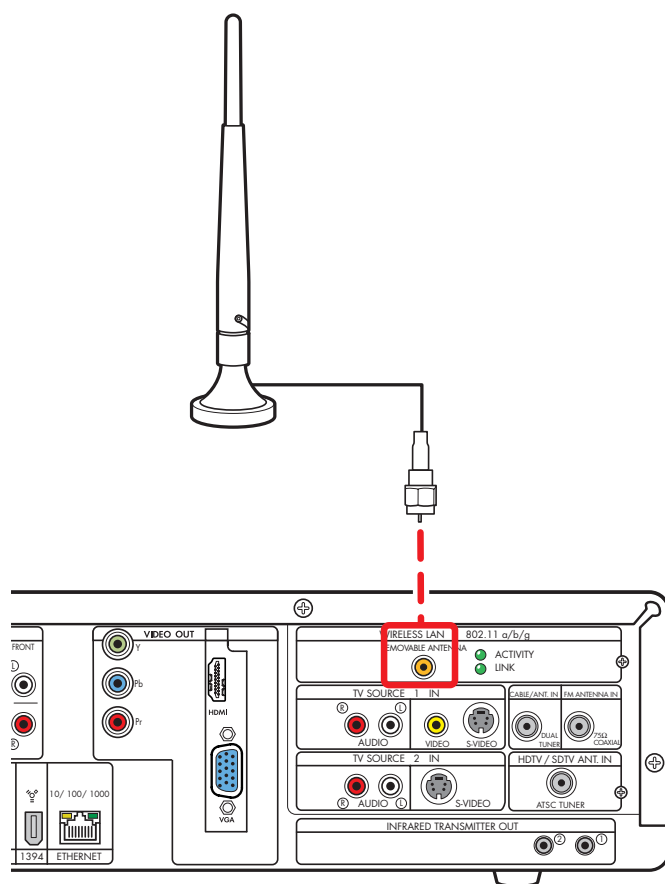

2 You may want to move the end of the antenna away from the HP Digital Entertainment Center to improve your signal reception.

3 Check to ensure that:

- a** The wireless router is connected to a DSL/cable modem.
- b** The DSL/cable modem is connected to an outside Internet connection.
- c** The wireless router power LED and connect LEDs are on.
- d** The DSL/cable modem power LED and connect LEDs are on.
- e** Your wireless network functions properly.

4 Select how you want to set up your network:

- a** If you would like a wireless connection between the HP Digital Entertainment Center and your existing wireless network, establish a wireless network using your HP Digital Entertainment Center as a client. The Media Center setup wizard has a step for this option. This is the default mode.
- b** If your HP Digital Entertainment Center is connected to the Internet and you would like to wireless-connect other machines to this HP Digital Entertainment Center, establish a wireless network using your HP Digital Entertainment Center as a wireless access point. For more information, refer to the *Quick Install Guide* and CD manual included in the Wi-Fi accessory box.

Connecting a DSL/Cable Modem

To connect the HP Digital Entertainment Center to the Internet, through an existing DSL or cable modem broadband connection:

- 1** Connect an RJ-45 network cable (sold separately) from the HP Digital Entertainment Center back panel Ethernet connector to a DSL or cable modem.
- 2** Check the following:
 - a** The DSL or cable modem is connected to an outside Internet connection.
 - b** The DSL or cable modem power LED and connect LEDs are on.

Refer to your DSL/cable modem and ISP documentation to establish a connection.

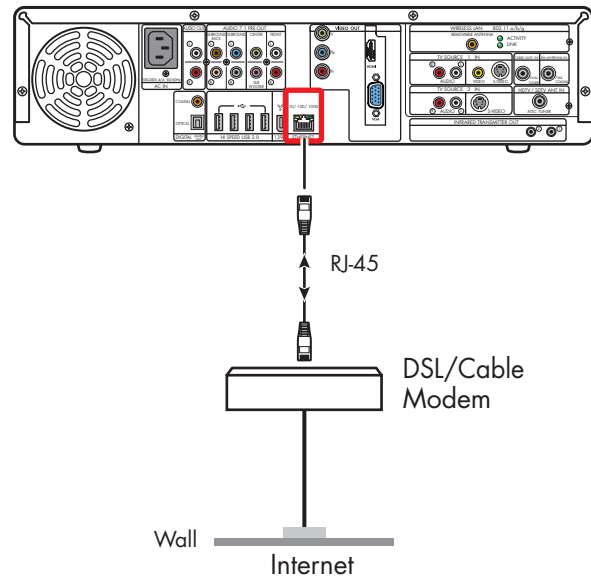

DSL/Cable modem direct Internet connection

Connecting Through a Router

If you already have a home network functioning, you can connect the HP Digital Entertainment Center to a LAN network and then to a DSL modem or cable modem. You can use your HP Digital Entertainment Center as a client if you already have a home network functioning.

Refer to your router, DSL/cable modem, and ISP documentation to establish a connection.

To connect the HP Digital Entertainment Center to the Internet, through a router and a broadband connection:

- 1 Connect an RJ-45 network cable (sold separately) from the HP Digital Entertainment Center back panel Ethernet connector to a 10BaseT, 100BaseT, or 1000BaseT port on the router.
- 2 Check that:
 - a The router is connected to the DSL/cable modem.
 - b The DSL/cable modem is connected to an outside Internet connection.
 - c The router power LED and connect LEDs are on.
 - d The DSL/cable modem power LED and connect LEDs are on.

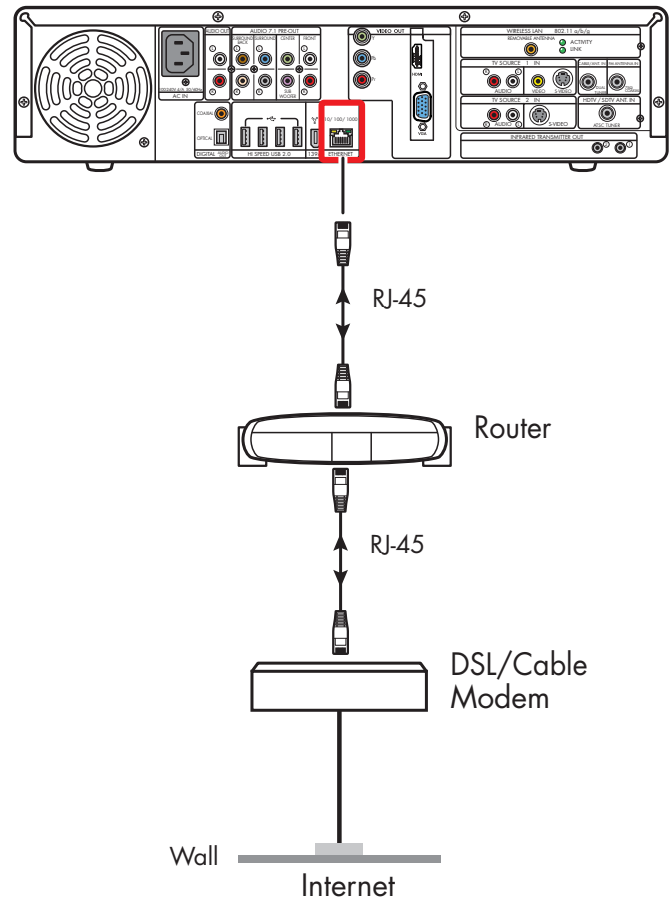

Router Internet connection

USB Device Connection

Digital Still Camera

The following instructions apply only to digital still cameras.

When connecting a digital still camera, use a USB connector on the front or back of the HP Digital Entertainment Center.

To connect a digital still camera:

- 1 Turn on the HP Digital Entertainment Center. Wait for the desktop to appear. Minimize or close Media Center.
- 2 Turn on the digital still camera. See the documentation that came with your camera.
- 3 Connect the camera transfer cable into the camera.
- 4 Connect the camera transfer cable into an open USB connector on the front or back of the HP Digital Entertainment Center. Most digital still cameras use either the USB or FireWire (IEEE 1394) connector.
- 5 A *Found New Hardware* message displays. Wait two or three minutes for the system to make the necessary settings for the new device. When installation is complete, a message displays telling you the camera is ready to use.

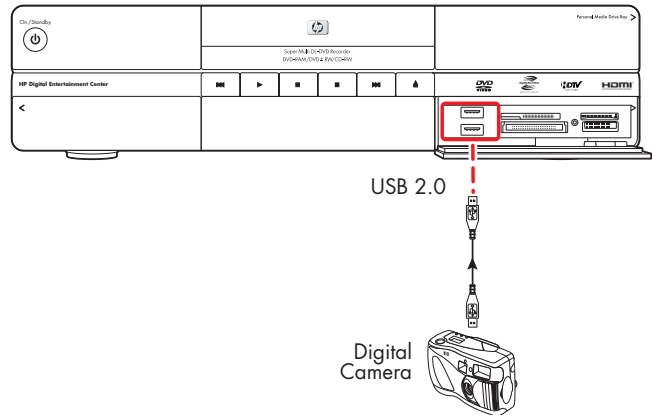

Digital still camera connection (front panel)

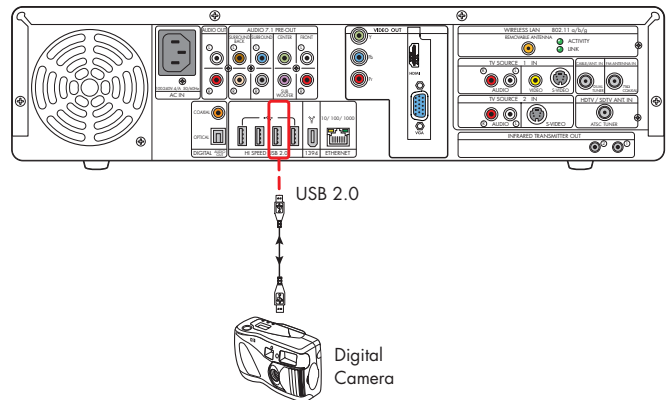

Digital still camera connection (back panel)

Other USB Devices

You can connect other peripheral devices to the front or back of the HP Digital Entertainment Center through USB or FireWire (IEEE 1394) ports.

The following devices can be connected to the HP Digital Entertainment Center USB 2.0 high speed ports:

- MP3 player
- USB drive
- External hard disk drive
- Printer
- Scanner
- Digital video camera
- Digital still camera
- PDA (Personal Digital Assistant)
- Keyboard
- Mouse

Peripheral devices are sold separately. See the documentation that came with your device. You can go to <http://www.hp.com> to purchase peripheral devices online.

To connect the HP Personal Media Drive to the HP Digital Entertainment Center through a USB, see the documentation that came with the HP Personal Media Drive.

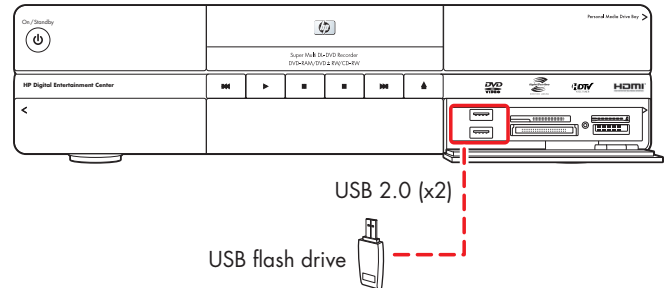

USB device connection (front panel)

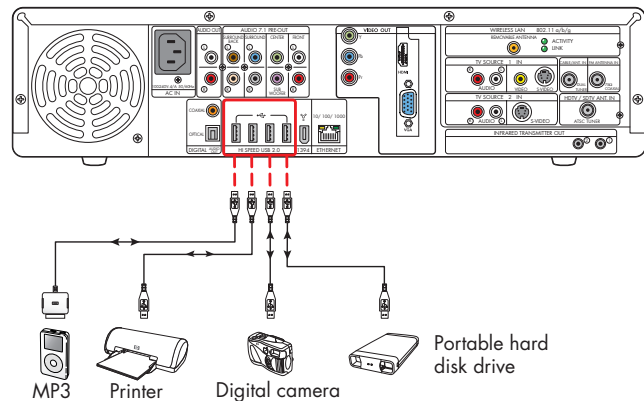

USB device connection (back panel)

Connecting an HP Personal Media Drive

The HP Digital Entertainment Center front panel includes a drive bay that houses the HP Personal Media Drive. The drive bay has an internal USB port and power connector.

The HP Personal Media Drive can also function as an external USB hard disk drive. You must connect an external USB port and power cable.

You can easily insert and remove the drive from the bay without turning off the HP Digital Entertainment Center.

You can use the HP Personal Media Drive without installing the included software. However, HP recommends that you install the software to have access to additional features and read the documentation.

For more information about installing the software, refer to the documentation that came with the HP Personal Media Drive. For more information about using an HP Personal Media Drive to store and transfer information, refer to the *HP Digital Entertainment Software Guide*.

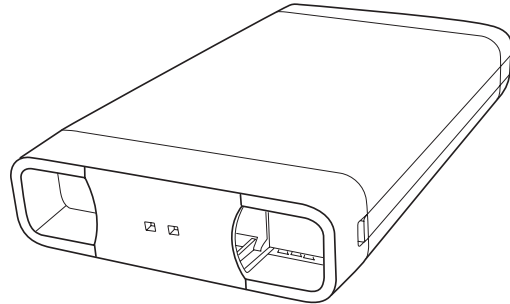

HP Personal Media Drive



Do not move the drive while it is operating, to avoid hardware damage and potential data loss. You can safely remove your drive only after you have completely run the Safely Remove Hardware wizard (located in the system tray at the bottom of the screen).

After you have safely disconnected and powered off the drive, handle the drive by the plastic endcaps to avoid touching the aluminum sides if they are hot.

The drive may feel warm. This is normal to allow faster heat dissipation.

Installing an HP Personal Media Drive

To connect an HP Personal Media Drive to the HP Digital Entertainment Center:

- 1 Install the HP Personal Media Drive software that is included with the drive (select models only).
 - For instructions about installing and using the HP Personal Media Drive software, refer to the documentation that came with your HP Personal Media Drive.
- 2 Open the HP Personal Media Drive bay front panel door.
- 3 Line up the ridges on the bottom of the drive with the two slots on the bottom of the drive bay.
- 4 Slide the drive all the way into the drive bay until the drive is firmly connected to the internal power and USB cables. Do not force the drive into the bay; it should slide easily into the bay.
- 5 If the HP Digital Entertainment Center is turned on, the blue power LED on the front of the drive lights up when the drive is inserted correctly.

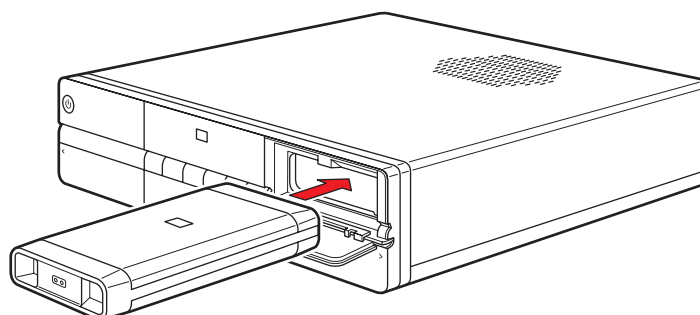

HP Personal Media Drive installation

Running the HP Personal Media Drive utility

To transfer files from your primary hard disk drive to your HP Personal Media Drive, you must first run the utility for each installed Media Drive to access the drive within Media Center:

- 1 Press Media Center on the remote control.

You can also click **Start** on the taskbar, and select **Media Center**.



- 2 Click **More Programs**, **HP Settings**, and then **HP Media Drive**.
- 3 Connect the HP Personal Media Drive.
- 4 Follow the onscreen instructions.

For instructions about using the HP Personal Media Drive software, refer to the documentation that came with your HP Personal Media Drive.

Disconnecting an HP Personal Media Drive

You can safely remove the HP Personal Media Drive when both the amber activity and blue power LEDs are off.



When your HP Digital Entertainment Center is in standby mode (a reduced power state), the drive turns off.

To disconnect your HP Personal Drive safely:

- 1 Close Media Center and all other programs that may be accessing your HP Personal Media Drive.
- 2 Double-click the **Safely Remove Hardware** icon in the system tray at the bottom of the desktop. If this icon is hidden, click the arrows on the taskbar to display it. The Safely Remove Hardware window opens. 
- 3 Double-click **USB Mass Storage Device** to locate your HP Personal Media Drive. USB Mass Storage Device may be listed twice. One may contain a memory card reader or other mass storage drive.
- 4 Select the **HP Personal Media Drive**, and then click **OK**. This name of the drive may appear as *Generic Volume*, followed by the assigned drive letter. A *Safe to Remove Hardware* message appears in the system tray at the bottom of your desktop letting you know that the device is safe to disconnect.
- 5 Click **Close**.
- 6 Open the HP Personal Media Drive bay front panel door.

- 7 Disconnect the drive from the HP Digital Entertainment Center.

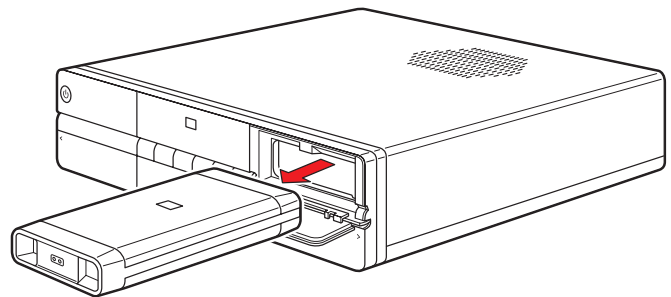

Disconnecting the HP Personal Media Drive



To avoid hardware damage and data loss, always disconnect the drive safely, when it is not active. When the amber LED is blinking, the drive is active, saving or transferring data.

Initial Configuration

This chapter describes how to set up your HP Digital Entertainment Center software, including how to configure the HP Digital Entertainment Center for proper operation.

When you complete the procedures in this chapter, you can use your HP Digital Entertainment Center in your home entertainment center. Refer to the *HP Digital Entertainment Center Software Guide*.



You should only perform the procedures in this chapter after all cables have been connected.

Chapter Contents:

"Starting the HP Digital Entertainment Center for the First Time" on page 128

"Windows Welcome" on page 131

"Media Center First Run" on page 132

"Configuring Audio" on page 135

"Configuring Video" on page 140

"Configuring the System" on page 150



Make sure you have followed all safety instructions for your HP Digital Entertainment Center, especially the important AC power information.

See "Safety Information" on page 17.

Starting the HP Digital Entertainment Center for the First Time

Turn power on to all connected devices such as TV and audio equipment before turning on the HP Digital Entertainment Center. Power on only after you have completed the full setup.

To set up your system:

"Installing the Keyboard Batteries (Initial)" on page 128

"Initial Startup" on page 129

"Synchronizing the Keyboard" on page 130

"Required Setup" on page 132

"Optional Setup" on page 132

"If Your Connections Don't Work" on page 133

"Adjusting the Front Panel Display Brightness" on page 134

Installing the Keyboard Batteries (Initial)

The keyboard comes with batteries preinstalled. The batteries are fresh from the factory.

- 1 Turn the keyboard over.
- 2 Pull the tab.



Use only AA alkaline batteries in the keyboard.

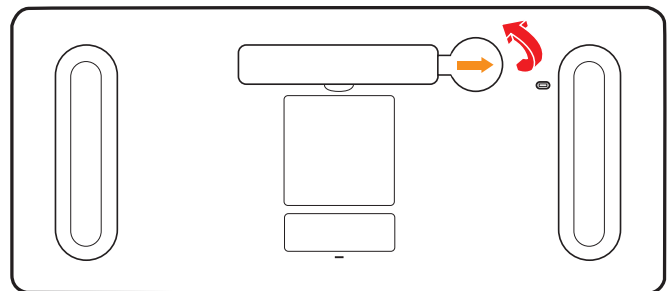

Initial Startup

After you have connected the equipment, you are ready to turn on the system.

- 1 Make sure the video and audio cables are connected before you turn on the TV and the HP Digital Entertainment Center.
- 2 Turn on all connected system equipment, such as TVs, set-top boxes, and AV receivers.



Set the volume to mid-level on the AV receiver and on the TV.

- 3 Plug the HP Digital Entertainment Center AC power cable into a wall outlet.
 - Use a surge protector to prevent power surges or voltage spikes.

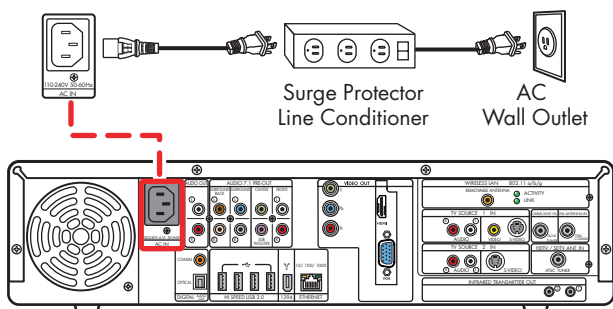

- 4 Press the On/Standby (power) button  on the front of the HP Digital Entertainment Center. The system starts.

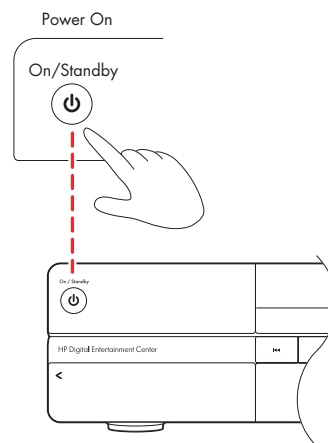

- 5 See "Synchronizing the Keyboard" on page 130.

The display on the TV screen may not be optimized until after you set the display settings.



Make sure you have followed all safety instructions for your HP Digital Entertainment Center, especially the important AC power information.

See "Safety Information" on page 17.

Synchronizing the Keyboard

Test the keyboard after the operating system is loaded.
Move the trackball to see if the cursor moves.

If the keyboard does not operate, you must synchronize the keyboard with the HP Digital Entertainment Center.

To synchronize the keyboard:

- 1 After you have made all connections and have performed the initial startup procedure, make sure the HP Digital Entertainment Center is turned on.
- 2 Briefly press the Keyboard Connect button on the HP Digital Entertainment Center front panel, behind the left door. The button will flash, indicating the system is ready to connect (synchronize) with the keyboard.

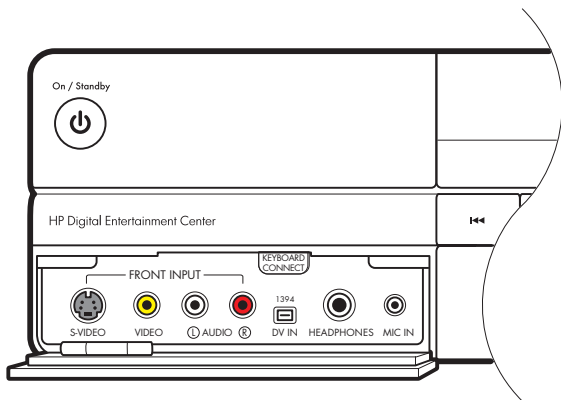

- 3 Press the red connect button once on the bottom of the keyboard. The front panel Keyboard Connect button flashes and stops, indicating a successful synchronization.

IMPORTANT: If you press the button twice, you will need to repeat steps 1 through 4.

- 4 Test the keyboard. Move the trackball, and see if the cursor moves.
- 5 If the keyboard does not operate:
 - a Check the batteries.
 - b Repeat steps 1 through 4.

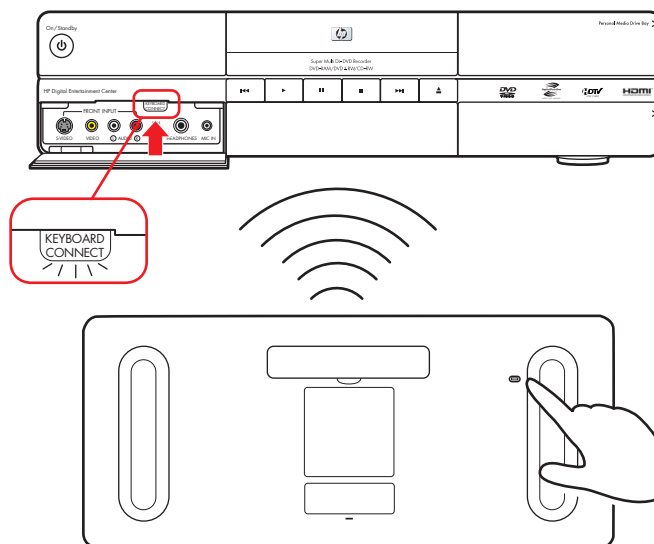

Windows Welcome

The system starts and displays the initial Microsoft® Windows® setup screen for the first power on only. You will need a mouse and keyboard to navigate the screens.

To set up Windows for the first time:

- 1 Follow the onscreen instructions for the initial Microsoft Windows setup.
- 2 Click **Next** to set up your system.
- 3 Select your country/region and language in System Settings. Change is optional. Click **Next**.
- 4 Select your Time Zone. Change is optional. Click **Next**.
- 5 Read the terms and conditions of the End User's License Agreement and if you agree, accept the terms and conditions. Click **Next**.
- 6 Select **Automatic Updates**. Click **Next**.
- 7 Name your system. Click **Next**.
- 8 Select **Finish**.
- 9 A countdown displays.
 - a After the countdown the screen goes blank.
 - b **Do not turn off your system** during this one time setup process. This takes approximately 8 to 10 minutes.
- 10 Windows restarts automatically.
- 11 After the system restarts, you will begin the Media Center first run. See "Media Center First Run" on page 132.

Initial Setup Wait Time

After you power up your system for the first time and complete the initial setup, you will see a welcome screen. This welcome screen will be displayed for one to three minutes, without any visible sign of system activity. During this period, your system is completing your account setup and should not be interrupted.

Please do not power off while the welcome screen is displayed. After it completes, the desktop will be displayed and the Media Center Setup Wizard will automatically launch.

Media Center First Run

The initial Media Center setup wizard consists of required setup and the optional setup.

Required Setup

The system displays the initial Media Center setup wizard for the first power on or until the Media Center setup is completed. The wizard includes steps for your network or broadband connections. Connect the HP Digital Entertainment Center to your wired network or broadband connections before you press the On/Standby button.



When Media Center is open, you can press F1 on the keyboard to open Media Center Help.

To set up Media Center for the first time:

- 1 Follow the onscreen instructions for the initial Media Center startup wizard. These instructions include choosing:
 - How Media Center connects to the Internet.
 - How to join a wireless network, if you have one.
 - How to join an existing (wired) network, if you have one.
- 2 The wizard sets up the required components. To continue, set up optional components as required. See "Optional Setup" on page 132.

Optional Setup

This procedure for optional components within the Media Center wizard can be completed at any time; you can define or change these settings using the Media Center settings.

In this portion of the Media Center wizard, you will:

- Configure tuners, TV signal, and Television Program Guide information.
- Select and adjust Media Center display settings.
- Set up speakers.
- Teach the HP Digital Entertainment Center to control your cable TV or satellite receiver set-top box.

To set up optional components in Media Center:

- 1 Follow the onscreen instructions for the Media Center Optional Components startup wizard.
- 2 Confirm your country/region.
- 3 Set up the TV signal, manually or automatically. Make sure a TV source is connected. The wizard scans for signals if you select automatic. It also sets up a set-top box.
- 4 Set up and download the Television Program Guide. You need your ZIP or postal code.
- 5 Choose and, if needed, adjust the display settings.
- 6 Choose the number of speakers you have. You can also test the speakers.
- 7 If you selected 5.1 or 7.1 speakers, or if you are using S/PDIF (digital), you must set the DVD player speaker settings. See "Configuring audio for the DVD player" on page 139.



When Media Center is open, you can press F1 on the keyboard to open Media Center Help.

If Your Connections Don't Work

You can use Media Center wizards to walk you through the connection process:

- 1 Press Media Center on the remote control.  You can also click **Start** on the taskbar, and select **Media Center**.
- 2 Click **Settings**.
- 3 Click one of the following topics:
 - General
 - TV
 - Pictures
 - Music
- 4 Follow the onscreen instructions.
- 5 If you cannot connect to the Internet, the wizard displays automatically.
 - DVD
 - Messenger and Caller ID
 - Radio
 - Help

Adjusting the Front Panel Display Brightness

You can adjust the brightness of the HP Digital Entertainment Center front panel media info display.

This setting does not control the brightness of the On/Standby (power) button or Media Center mode status LEDs.

To adjust the front panel display brightness:

- 1** Press Media Center on the remote control. 
You can also click **Start** on the taskbar, and select **Media Center**.
- 2** Click **More Programs, HP Settings**, and then **Front Panel**.
- 3** Select **Auto Adjustment** or **Manual Adjustment**.
Auto Adjustment changes the display brightness based on the room light level.
- 4** Change front panel brightness manually by selecting the + (plus) and – (minus) symbols.
- 5** Click **Save**.

Configuring Audio

You may have to optimize your HP Digital Entertainment Center audio configuration to get the best sound on your audio system.

Select the configuration that most closely matches your home system. See:

"Connecting Headphones" on page 135

"Connecting a Microphone" on page 135

"Adjusting the Volume" on page 136

"Configuring Audio Output" on page 138

Connecting Headphones

Your HP Digital Entertainment Center comes with a headphones connector (1/4 inch [6.5 mm]) on the front panel.

You can connect a mini plug adapter (sold separately) into the 1/4 inch (6.5 mm) plug to use 1/8 inch (3.5 mm) mini-jack headphones.

The Audio Out speakers are muted when you plug in the headphones, but S/PDIF does not mute.

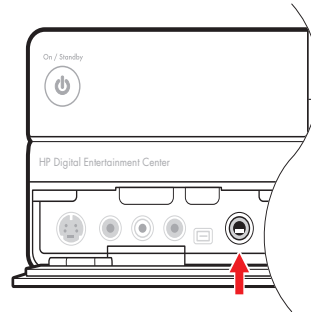

Connecting a Microphone

Your HP Digital Entertainment Center has a microphone connector on the front panel.

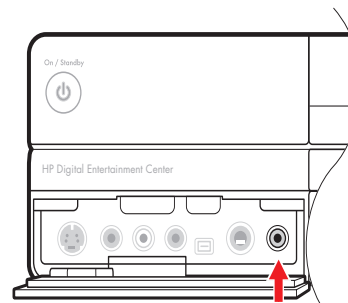

Selecting recording devices

To select a sound recording device:

- 1 Click **Start** on the taskbar.
- 2 Choose **Control Panel**.
- 3 Click **Sounds and Audio Devices** (or **Sounds, Speech, and Audio Devices**). The Sounds and Audio Devices window opens.
- 4 Click the **Audio** tab. The window opens.
- 5 In the Sound Recording area, click the **Volume** button, and then choose the source for sound recording.
- 6 Click **OK**.
- 7 Close the window.

This window is easier to read on a monitor. You can lower the display resolution to read the window. You will need the keyboard and mouse.



Audio distortion may occur if recording volume is set too high.

Adjusting the Volume

To adjust speaker volume, use the:

- Remote control
- TV
- AV receiver
- Buttons on the keyboard
- Volume knob on the speakers
- Volume knob on the subwoofer
- Volume knob on the monitor (if connected)
- Volume controls within a program, such as the volume buttons on the Media Center navigation bar or on the remote control
- Volume icon on the taskbar
Double-click and adjust the volume.



Ensure that the mute box is *not* checked.

Some applications may play back at low volume, even when the volume knob is turned to the maximum position. If this is the case, double-click the **Volume** icon on the taskbar and increase the volume.

Locating the volume icon

If you do not see the Volume icon on the taskbar:

- 1 Click **Start**, and then **Control Panel**. Click **Sounds, Speech, and Audio Devices**, if it is available.
- 2 Double-click **Sounds and Audio Devices**. The Sounds and Audio Devices Properties window opens.

This window is easier to read on a monitor. You can lower the display resolution to read the window. You will need the keyboard and mouse.
- 3 Click the **Volume** tab. Place a check in the **Place volume icon in the taskbar** check box.
- 4 Click **Apply**, and then click **OK**. The Volume icon appears in the taskbar.



Volume cannot be controlled from the HP Digital Entertainment Center remote control if the S/PDIF digital audio out connects to your AV receiver. Control the sound from your AV receiver.

Configuring Audio Output

You must adjust the audio settings in two places after you have installed and connected the HP Digital Entertainment Center to your audio system.

Configure both the Media Center speaker settings and audio for the DVD player.

The following table shows which procedures to perform for your audio system. If you set up speakers using the Media Center Optional Components wizard, then set up the audio for the DVD player only.

Media Center speaker settings (TV Audio)	DVD audio setting	Procedure
2 <i>(default)</i>	2 speakers; Dolby Surround Compatible <i>(default)</i>	Default, no audio output configuration required.
5.1	5.1	Change settings. See "Configuring audio for Media Center" on page 139 and "Configuring audio for the DVD player" on page 139.
7.1	7.1	Change settings. See "Configuring audio for Media Center" on page 139 and "Configuring audio for the DVD player" on page 139.
Digital Audio S/PDIF on <i>(default)</i>	Digital Audio S/PDIF off <i>(default)</i>	Change settings. See "Configuring audio for the DVD player" on page 139. If you use digital audio, the Media Center S/PDIF default setting is on, but the DVD Player S/PDIF default setting is OFF. You must change the DVD S/PDIF default setting to ON to hear all channels in DVD digital audio.

Configuring audio for Media Center

To configure multichannel audio output for Media Center audio:

- 1 Press Media Center on the remote control. 

You can also click **Start** on the taskbar, and select **Media Center**.
- 2 Click **Settings, General, Media Center Setup**, and then **Setup your Speakers**. The Speaker Setup screen displays.
- 3 Click **Next**.
- 4 Under *Specify how many speakers you have*, select the speaker number that matches your system. For example, select **5.1**. Click **Next**.
- 5 Select the type of cable that connects your Media Center audio receiver. For example, select **Mini plug (analog)**. Click **Next**.
- 6 Select **Test**. If you hear tones from all your speakers, click **Next**. If you do not hear tones from all your speakers, follow the onscreen instructions.
- 7 Click **Finish**.



Reduce the volume level before changing channels. Exercise particular caution when changing from ATSC to NTSC channels. Your analog NTSC channel audio levels may be noticeably higher than your SD/HDTV channel audio levels. The channel sound volume is controlled by the content provider.



If your speaker configuration is not displayed, click the Sound Effect (speaker) icon in the desktop system tray.

Configuring audio for the DVD player

To configure multichannel audio output for the Media Center DVD playback:

- 1 Press Media Center on the remote control. 

You can also click **Start** on the taskbar, and select **Media Center**.
- 2 Click **Settings, DVD**, and then **Audio**.
- 3 Select how many speakers you have under *Speaker Environment*. Select your Output Mode, and Audio Channel Expander, if needed. Set sound output to match your speaker system. For example, select **5.1** for analog audio connections. If you have a digital audio connection, select S/PDIF.

Configuring Video

You may have to optimize your HP Digital Entertainment Center video configuration to get the best image on your TV/display screen.

Select the configuration that most closely matches your home system. See:

"Configuring Video Output" on page 140

"Dual screen" on page 140

"Adjusting the Desktop Display" on page 143

"Finding ATSC HDTV and Standard TV Channels" on page 148

"Tuning the Desktop Display" on page 148

Configuring Video Output

You can configure your HP Digital Entertainment Center video for dual-display. For instance, you can view the screen on your TV and your monitor if both are connected. You can also set up additional displays. See "Video Out to TV and Monitor" on page 68 to connect your TV and monitor.

If you have a multichannel sound system, and the broadcast is only 2-channel, you may not hear all the sound; you may need to change your audio settings to 2.0/2.1. Then change the settings back for multichannel broadcasts.

Video software can change periodically; check HP Support for updates. Go to <http://www.hp.com/support> and select your model number.



Your TV and monitor must be connected to the HP Digital Entertainment Center before turning on the power to see the display on two screens.

Dual screen

The HP Digital Entertainment Center can connect more than one display device (CRT monitor, flat panel monitor, TV, and so on) to the HP Digital Entertainment Center.

The display defaults to the monitor after turn on if you have two displays connected. You must set up the TV manually. This is also called "cloning". The screen resolution may change if you switch to two displays.

See "Viewing the screen image on a second display" on page 141.

140 *HP Digital Entertainment Center*

Changing screens

Once you have connected a second display and your display is set to Single Display mode, you can quickly switch between displays by pressing Alt+F5. (Press the Alt key and the F5 key on the keyboard at the same time.)

Each time you press the Alt+F5 key combination, the HP Digital Entertainment Center desktop appears on the next device. If Alt+F5 does not work, restart the HP Digital Entertainment Center and try again.

Viewing the screen image on a second display

To view your screen image on a second TV or monitor:

- 1 Make sure the video and audio cables are connected before you turn on the TV or monitor, and the HP Digital Entertainment Center.
- 2 Turn on the TV or monitor. Press the Video/TV button on the TV remote control to select the Video input.
- 3 Turn on the HP Digital Entertainment Center.
- 4 Right-click on the desktop, and click **NVIDIA Control Panel** in the dialog box.
- 5 When the NVIDIA Control Panel window opens, click the **Display** category.

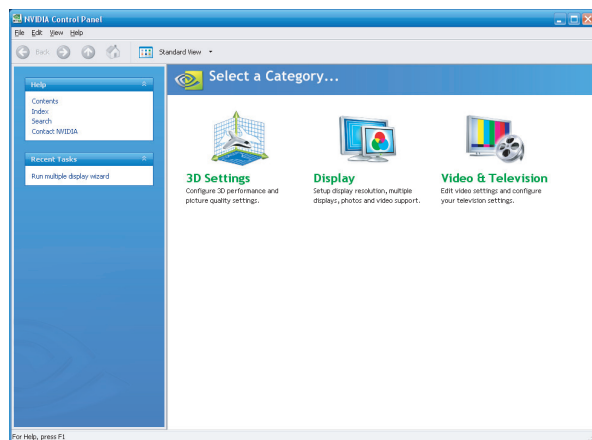

Control Panel window

- 6 Click **Run multiple display wizard**.

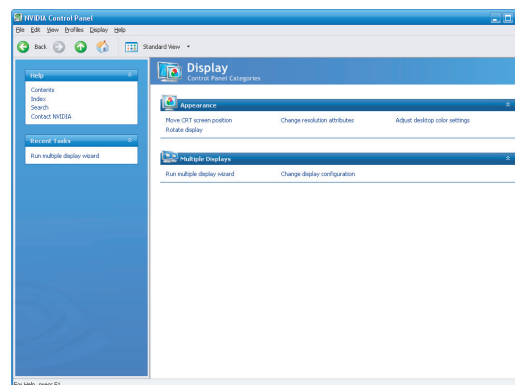

- 7 Select the definition type for your HDTV, and then click **Next**.

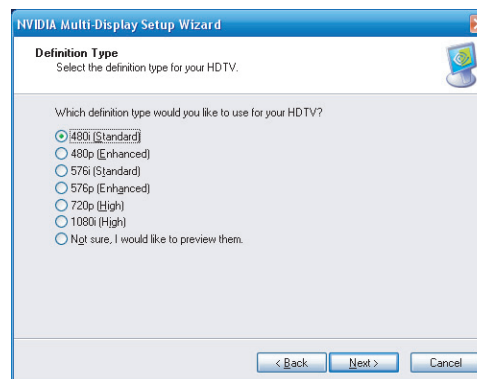

- 8 Select **Dual View** to set up an extended desktop between two displays where each display has a separate resolution, color depth and refresh rate. Click **Apply** and go to step 9.

Or

Select **Clone** to show the same information on two displays. Click **Apply** and go to step 10.

- 9 Select the screen resolution for the secondary display by clicking the drop-down arrow.

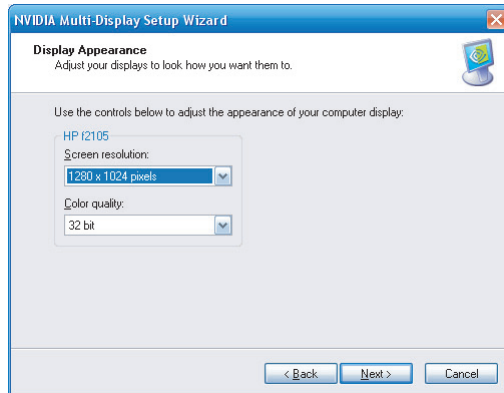

- 10 Click **Preview** to see how the display appears.

- 11 Click **Yes** to keep the setting. You have 15 seconds to accept this new setting before it reverts to the previous setting.

- 12 Click **Finish** to complete the wizard.

Disabling the dual screen option

When you want to disconnect the TV from the HP Digital Entertainment Center, you may need to disable the dual screen option to return your HP Digital Entertainment Center display to its original resolution.

To disable the TV or monitor dual screen option and view your HP Digital Entertainment Center image on the original display:

- 1 Right-click on the desktop, and click **NVIDIA Control Panel** in the dialog box.
- 2 When NVIDIA Control Panel window opens, click the **Display** category.
- 3 Select **Only use one display (Single)**.

- 4 Click the drop-down arrow and select the display you want to use, and then click **Apply**.

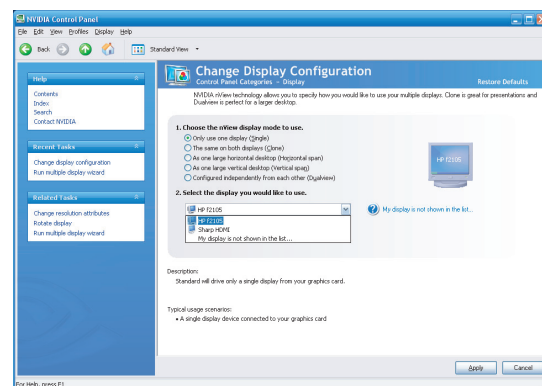

Disconnecting the TV

To disconnect the TV:

- 1 Disable the TV option. See "Disabling the dual screen option" on page 142.
- 2 Turn off the TV and the HP Digital Entertainment Center.
- 3 Remove the video cable from the HP Digital Entertainment Center Video Out and TV In.

Adjusting the Desktop Display

Some tasks on the HP Digital Entertainment Center require that you leave Media Center and use the Windows XP desktop. Because Windows XP is not specifically designed for TV, some messages and dialogs on the desktop may be difficult to read on some TVs.

Increasing the display resolution can make messages and dialogs easier to read by enlarging the text. Lowering the display resolution can make messages and dialogs harder to read.

This procedure is an example only and may vary depending on your TV/display type, supported formats, and video out connections. You may have to perform the procedure more than once to optimize the image.

You can adjust the display using:

- The Media Center wizard. See "Adjusting the Display in Media Center" on page 144.
- Or
- From the desktop. See "Adjusting the Display from the Desktop" on page 145.



You may have to perform this procedure before and after playing a commercial DVD video in component video, due to copy protection measures.



This setup procedure is advanced. Knowledge of video concepts and computer terms is helpful. Follow the steps carefully. Your TV/display may require settings and configurations different than those listed in the following procedures.

Adjusting the Display in Media Center

Before you begin, verify that the video equipment is properly connected to the HP Digital Entertainment Center and turned on, and ensure that your TV screen is set to normal mode (not letter-box, wide, or re-sized).



Refer to the *TV/Display Setup Guide* for more detailed information about adjusting the Display.

To adjust the video settings in Media Center:

- 1** Press Media Center on the remote control. 
You can also click **Start** on the taskbar, and select **Media Center**.
- 2** Click **More Programs**, **HP Settings**, and then **Video Settings**.
- 3** Click **Display/Connection Wizard**.
- 4** Verify that the video equipment is properly connected to the HP Digital Entertainment Center and turned on. Click **Next**.



You may also need to perform the HDTV Overscan procedure, depending on the type of TV/display and video connection.

- 5** Follow the onscreen instructions. The options vary depending on which Video Out connection you use (HDMI, VGA, or component).

DVD Playback

You may have to perform the Adjusting the Desktop Display procedure before and after playing a commercial DVD video in component video, due to copy protection measures.

To play a commercial DVD video in component video, the resolution format must be set to 480i or 480p. The DVD will not play after it is inserted into the drive, and you may see an error message when you try to play the DVD in component video and the resolution format is set above 480i or 480p.



You may have to perform the “Adjusting the Desktop Display” procedure before and after playing a commercial DVD video in component video, due to copy protection measures.

To play a commercial DVD video, in component video, in Media Center:

- 1 Press Media Center on the remote control. 

You can also click **Start** on the taskbar, and select **Media Center**.
- 2 Click **More Programs, HP Settings**, and then **Video Settings**.
- 3 Click **DVD Mode (480p)**. (Select this mode only if your TV supports 480p mode.)
- 4 After playing the commercial DVD video in component video, perform the Adjusting the Desktop Display procedure to return the desktop image and Media Center to a higher resolution format. See “Adjusting the Desktop Display” on page 143.

Adjusting the Display from the Desktop

You can also use the following procedures to adjust the TV video settings. These procedures are examples only and may vary depending on your TV/display type, supported formats, and video out connections. You may have to perform the procedure more than once to optimize the image.

You can use this window to adjust the TV video image in component video out. This window is not available for single displays in HDMI, DVI, or VGA video out. Use the Media Center HP Settings wizard to adjust these displays.

Before you begin, verify that the video equipment is properly connected to the HP Digital Entertainment Center and turned on, and ensure that your TV screen is set to normal mode (not letter-box, wide or re-sized).

To adjust the video settings from the Windows desktop:

- 1 Right-click on the desktop, and click **NVIDIA Control Panel** in the dialog box.
- 2 When NVIDIA Control Panel window opens, click the **Video & Television** category.

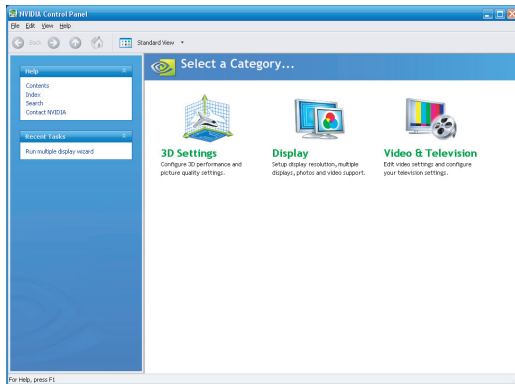

- 3 Select **Change the signal or HD format**.

- 4 Select your options
 - a Select the display you want to change.
 - b Select the connector you want to use.
 - c Select the signal format to a type that is supported by your TV. (For commercial DVD playback in component video, select: 480i or 480p.)

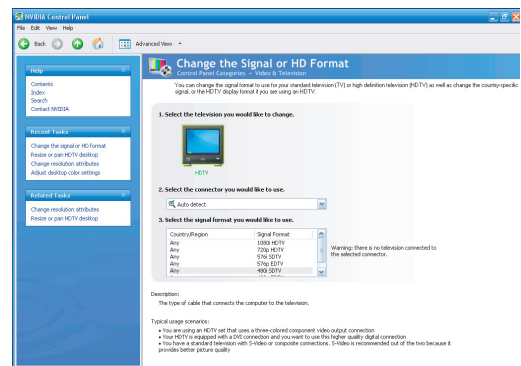

- 5 Click **Apply** and then click **Yes** to save changes.
- 6 Perform HDTV Overscan Configuration, as required. See "HDTV Overscan Configuration" on page 147. The HDTV Overscan Configuration window may open, depending on the type of TV/display and video connection.

HDTV Overscan Configuration

To use underscan to show the entire Windows desktop:

- 1 Right click on the desktop, select **NVIDIA Control Panel**.
- 2 Click **Video & Television**.
- 3 Click **Resize or pan HDTV desktop**. This option does not appear when the resolution is set below 720.
- 5 Move the horizontal and vertical scroll bars in the center of the window to adjust the size of your desktop display.

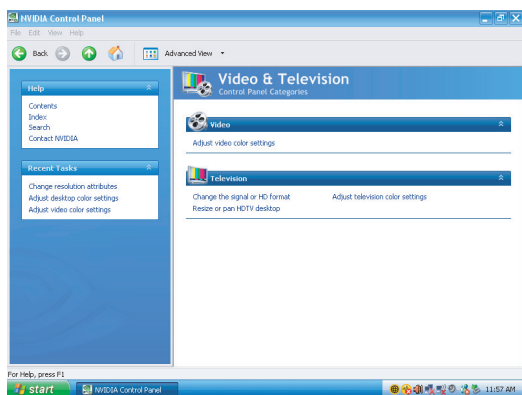

- 4 If you have more than one display connected to your HP Digital Entertainment Center:
 - a Select the TV you want to change
 - b Select the **Resize my desktop** option.
 - c Click the **Resize Desktop** button.



- 6 Click **OK** to save the changes.



You cannot use HDTV Overscan Configuration for 480i or 480p. HP recommends that you use 720i/p or 1080i to avoid overscan issues.

Finding ATSC HDTV and Standard TV Channels

(Select models only)

After you complete the Media Center and Digital TV setup wizards and then download your TV Program Guide, the Media Center TV Program Guide may display incorrect ATSC DTV channels. Some channels may have an incorrect channel number and other channels may not be displayed at all. These HDTV channels may be available in your area, but they may not be listed in the Media Center TV Program Guide.

A more complete ATSC TV channel guide may be available from third party providers, such as Titan TV. For more information, see the Media Center Online Spotlight.

To view or record HDTV content, you need an HP Digital Entertainment Center with ATSC tuner (included) and UHF/VHF antenna (sold separately).



Broadcasters sometimes use two channels: one for Standard TV (NTSC) and one for HDTV (ATSC DTV). An HDTV channel can broadcast several programs at the same time.

Tuning the Desktop Display

The HP Digital Entertainment Center desktop default screen resolution is 800 by 600 pixels. In the default format, the Windows desktop on your TV/display screen may show a black border around it. You may also see that the video image is larger than your TV/display (overscan).



Only advanced users should attempt to perform this procedure. If you cannot see a screen image, go to <http://www.hp.com/support> and select your model number for detailed information on advanced video setup.

Adjusting the Video Image

To adjust the video settings from the Windows desktop:

- 1 Right-click on the desktop, and click **NVIDIA Control Panel** in the dialog box.
- 2 When NVIDIA Control Panel window opens, click the **Video & Television** category.

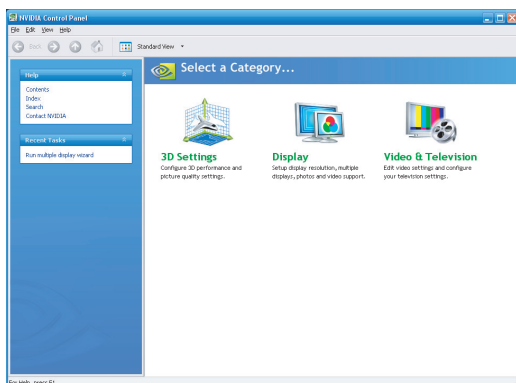

- 3 Select **Change the signal or HD format**.
- 4 Select your options
 - a Select the display you want to change.
 - b Select the connector you want to use.
 - c Select the signal format to a type that is supported by your TV. (For commercial DVD playback in component video, select: 480i or 480p.)

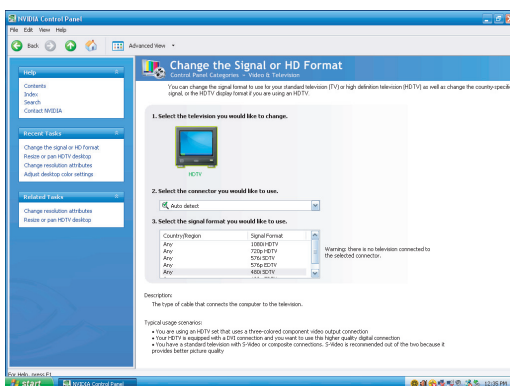

- 5 Click **Apply** and then click **Yes** to save changes.

- 6 Click the Home icon  in the taskbar.
- 7 Click the **Video & Television** category.
- 8 If you are using a Component Video Out connection with your display, select **Adjust television color settings**. Move the Brightness and Contrast slider bars to adjust the color settings.

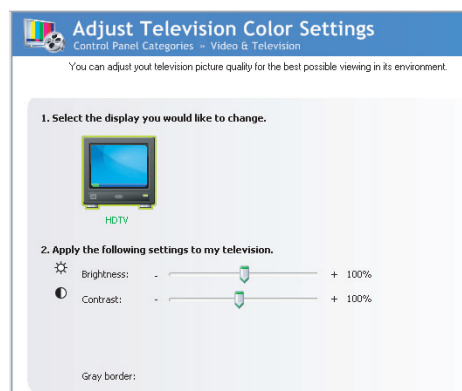

Or

If you are using a VGA, DVI, or HDMI Video Out connection with your display, select **Adjust video color settings**. Move the slider bars to adjust your color settings.

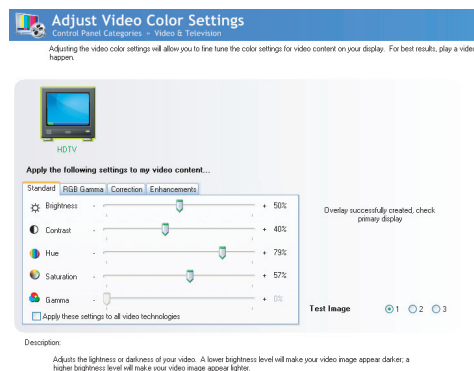

- 9 Click **Apply**.
- 10 Close the Adjust Video Color Settings window.

Configuring the System

You can customize your HP Digital Entertainment Center system settings.

See:

"Configuring the Keyboard Buttons" on page 150

"Registering with HP" on page 151

"Setting Up Virus Protection" on page 151

"Transferring Information from Your Old PC to Your HP Digital Entertainment Center" on page 152

"Installing Software" on page 153

"Utility Programs" on page 153

Configuring the Keyboard Buttons

You can configure some of your HP Digital Entertainment Center shortcut keyboard buttons.

- 1 Click **Start** on the taskbar, choose **Control Panel**, and then click **Printers and Other Hardware**, if it is available.
- 2 Double-click **Keyboard**.
- 3 In the Keyboard Properties window that opens, click the **Buttons** tab.
- 4 Double-click the button you want to change.
- 5 Choose the button capability from the drop-down list. Enter the Display label and Address information.
 - For a Web site, enter the complete Web site URL in the Address box. Example:
http://www.hp.com/support
- 6 Click **OK**.
- 7 On the Buttons tab, click **Apply**. Repeat steps 4 through 6 for other buttons.
- 8 Click **OK** when you are finished.

Registering with HP

To register with HP to receive changes, updates, and support:

- 1 Press Media Center on the remote control.



You can also click **Start** on the taskbar, and select **Media Center**.

- 2 Click **More Programs**, **HP Support**, and then **Register Now**.

- 3 Follow onscreen instructions, using the keyboard and trackball.

You can also register with HP in the following ways:

- Double-click the registration icon on your desktop, and follow onscreen instructions.
- Register online at:
<http://register.hp.com>

Setting Up Virus Protection

You should use virus protection if you connect to the Internet. Your HP Digital Entertainment Center comes with a free, six-month subscription with Norton Internet Security software.

Changing the Virus Scan Time for Your Norton Internet Security Program

After you set up this program, the scan time is set for Monday at 4:00 p.m. If you want to reset this time, complete the following procedure. To change the Norton Internet Security scan time:

- 1 Set up Norton Internet Security program by following the onscreen instructions when prompted.
- 2 Double-click the **Norton Internet Security** icon in the system tray to open the Norton AntiVirus program.
- 3 On the left side of the window, click **Norton AntiVirus**.



- 4 On the left side of the main window, select **Scans**.

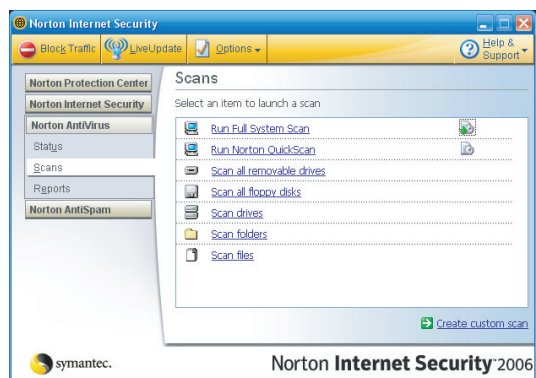

- 5 Click the **Schedule** icon next to *Run a Full Scan*. 
- 6 Change schedule options by clicking the drop-down arrows, and then click **OK** to save your changes.

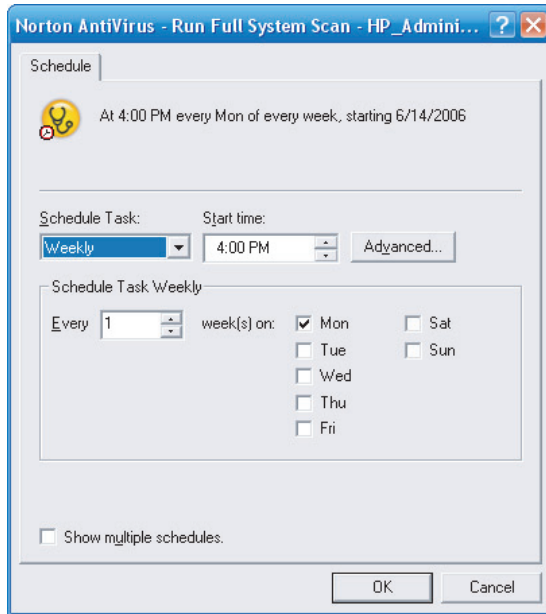

If the PC is in Standby mode, the Norton Internet Security program does not perform a scheduled antivirus scan.



Performing an antivirus scan during a scheduled Media Center recording can result in failed recordings.

Transferring Information from Your Old PC to Your HP Digital Entertainment Center

See the built-in Microsoft Windows Help and Support Center; search for *transfer wizard* and select the overview article, *Files and Settings Transfer Wizard Overview*. This information describes a Microsoft solution for moving your files to your new HP Digital Entertainment Center.

Installing Software

After you turn on the HP Digital Entertainment Center the first time and then restart it, you can install any additional software programs that came on CDs or DVDs included in the HP Digital Entertainment Center box (select models only).

You may wish to install additional software programs or hardware devices on your HP Digital Entertainment Center. Restart the HP Digital Entertainment Center after installation.

Choose software that is compatible with your HP Digital Entertainment Center; check the operating system, memory, and other requirements listed for the new software for compatibility with your HP Digital Entertainment Center.

Install the new software according to the directions provided by the software manufacturer. Check the manufacturer's documentation or customer service information for help if you need it.

Utility Programs

HP Settings

HP provides special utility programs in the HP Digital Entertainment Center Media Center that configure the desktop display, adjust front panel brightness, and setup the HP Personal Media Drive.

To use Media Center utility programs:

- 1 Press Media Center on the remote control.



You can also click **Start** on the taskbar, and select **Media Center**.

- 2 Click **More Programs** and then **HP Settings**.

- 3 Select a program or folder:

- Front Panel
- HP Media Drive
- Video Settings

System utilities

HP provides special utility programs in the PC Help & Tools folder that display support information and initiate Application or System Recovery.

To use utility programs:

- 1 Click **Start**, choose **All Programs**, and then **PC Help & Tools**.
- 2 Select a program or folder:
 - HP Application Recovery
 - HP Support Information
 - HP PC System Recovery
 - PC Doctor
 - System Restore

Using Standby Mode and Quick Resume Mode

You can use both Standby and Quick Resume modes to save power when the HP Digital Entertainment Center is not in use. There are some differences between these settings which are outlined in the following sections.

You can have both Standby mode set and Quick Resume mode enabled so that after a determined time-out period, the PC reverts to Standby mode which places the PC in a reduced power state. If you have both Standby mode and Quick Resume mode set, Standby mode will override Quick Resume mode unless the TV tuner is active (for example, recording or playing a live TV). The PC does not time-out to Standby mode; it remains in Quick Resume mode and the fan remains running.

What is Standby Mode?

When the HP Digital Entertainment Center is in Standby mode:

- The display is turned off, audio is muted, the fan and the hard disk are turned off, and the PC is set to a minimal power setting.
- The PC can automatically return to a full-powered state and record a scheduled TV program.
- The desktop can be displayed after several seconds when you press the sleep button on your remote control.

What is Quick Resume Mode?

When the HP Digital Entertainment Center is in Quick Resume mode:

- The display is turned off, audio is muted, and the PC is kept fully operational but in a reduced-power setting.
- The PC fan is always running.
- The PC can still perform tasks such as recording scheduled TV programs or stream video and music files.
- The desktop can be displayed almost instantly when you press the sleep button on your remote control.

Changing the Standby Mode Power Setting

Your HP Digital Entertainment Center comes with the Standby mode set to 25 minutes of inactivity by default.

To change Standby mode settings:

- 1 Click **Start** on the taskbar.
- 2 Click **Control Panel**.
- 3 Click **Performance and Maintenance**.
- 4 Click **Power Options**.
- 5 Select the **Power Schemes** tab.
- 6 Select your settings by clicking the drop-down arrows.
- 7 Click **OK**.
- 8 Restart the PC for the power settings to take effect.

Enabling the Quick Resume Mode Power Setting

Your HP Digital Entertainment Center comes with the Quick Resume mode disabled by default.

To enable the Quick Resume mode:

- 1 Click **Start** on the taskbar.
- 2 Click **Control Panel**.
- 3 Click **Performance and Maintenance**.
- 4 Click **Power Options**.
- 5 Select the **Quick Resume** tab.

- 6 Place a check mark in the **Enable Quick Resume mode** check box.

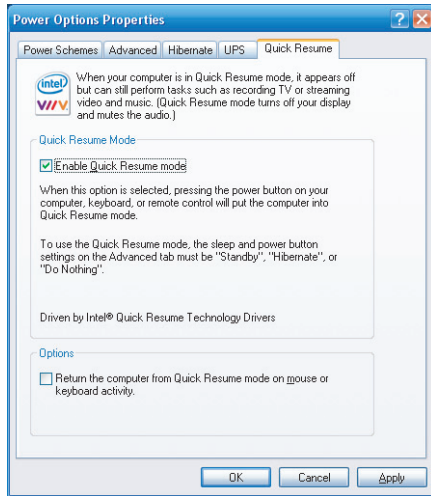

- 7 Under *Options* you can place a check mark next to the following options:

Return the computer from Quick Resume mode on mouse or keyboard activity

Or

Prompt for password when the computer returns from Quick Resume mode

- 8 Click **OK**.

- 9 Restart the PC for the power settings to take effect.



Selecting the option *Return the computer from Quick Resume mode on mouse or keyboard activity* is not recommended, as this resumes the PC out of Quick Resume mode if the keyboard or trackball is slightly moved.

After you have enabled Quick Resume mode in the Control Panel, you can activate or wake the PC from Quick Resume mode by pressing the Power button on your HP Digital Entertainment Center, or by pressing the standby button on the keyboard or remote control.

Using the Media Center Optimization Utility

The optimization utility is designed to keep your HP Digital Entertainment Center running smoothly if Media Center is left open for long periods of time. Media Center can be left open because of various scheduled TV recordings or because the PC enters Standby or Quick Resume mode while Media Center is still open.

During an optimization, Media Center automatically closes and then opens at a scheduled time if there has not been any activity in Media Center for 30 minutes. If it cannot be performed, the optimization is skipped until the next scheduled time.

To enable the Media Center optimization utility:

- 1 Click **Start** on the taskbar.
- 2 Click **Media Center**.
- 3 Select **Settings, General**, and then select **Optimization**.
- 4 Place a check next to *Perform Optimization* to enable the optimization utility.
- 5 Enter the time you want the optimization to occur by using your keyboard or your remote control.
- 6 Select **Save**.



Optimization is skipped if a CD is being recorded, media is being downloaded from the Internet, or if any media except Live TV is playing, paused, or stopped.

Troubleshooting

This section contains possible solutions for some problems you may be experiencing with the HP Digital Entertainment Center.

Chapter Contents:

To solve audio problems, see "Audio" on page 160.

To solve video problems, see "Video" on page 162.

To solve system problems, see "System" on page 164.

For other sources of information, see "Getting Help" on page 170.

Problems and Solutions

Audio

Find the description that most closely matches your audio problem, and try the corresponding solution.

Problem	Solution
I don't have sound from my speakers.	<ul style="list-style-type: none">■ Use active, powered speakers or speakers with an amplifier.■ Verify sound cable connections.■ Check Volume and Mute settings. See "Adjusting the Volume" on page 136.■ Reconfigure the software for surround sound. See "Configuring Audio Output" on page 138.■ Reinstall the sound card drivers by using Application Recovery. See the <i>Warranty and Support Guide</i> that came with your HP Digital Entertainment Center.
I have low volume sound from my speakers.	<ul style="list-style-type: none">■ Check volume and mute settings. See "Adjusting the Volume" on page 136.■ Some programs may result in low volume, even when the volume setting within the program is turned to the maximum position. If this is the case, double-click the Volume icon on the taskbar and increase volume.
My TV audio volume increases or decreases when I change channels.	Reduce the volume level before changing channels. Exercise particular caution when changing from ATSC to NTSC channels. Your analog NTSC channel audio levels may be noticeably higher than your SD/HDTV channel audio levels. The channel sound volume is controlled by the content provider.

Problem <i>(continued)</i>	Solution
<p>The HP Digital Entertainment Center doesn't make any sound.</p>	<ul style="list-style-type: none"> ■ Check that the AV receiver or powered speakers are turned on and are set to the proper input. ■ Increase the volume on the AV receiver or the HP Digital Entertainment Center remote control. ■ Press the Mute button on the HP Digital Entertainment Center keyboard or on the remote control to see if the Mute feature is turned on. ■ Use the keyboard controls to increase the volume. ■ Click the Volume icon on the Windows taskbar. Increase the volume, and make sure the Mute box is not checked. ■ Double-click the Volume icon on the Windows taskbar. The Play Control window opens. Make sure none of the Mute check boxes are selected. Adjust the volume slide bars to increase volume. ■ If your speakers have a Power button, check whether it is turned on and whether the power supply is connected to the power source. ■ Check the speaker connections. ■ Remove any connected headphones.
<p>Surround sound isn't working.</p>	<p>See "Configuring Audio Output" on page 138.</p>

Video

Find the description that most closely matches your problem, and try the corresponding solution.

Problem	Solution
I am using a TV with the HP Digital Entertainment Center, but I cannot see anything.	<ul style="list-style-type: none">■ Check that the correct input source is selected on the TV.■ Check that the TV is connected to the HP Digital Entertainment Center. See "Video Out to TV" on page 63.■ Check that the TV Out image is enabled. See "Configuring Video" on page 140.
I cannot see anything on the TV. I can hear it, though.	<ul style="list-style-type: none">■ If the Video Output S-video and composite connections are not connected to a TV or Video Input when the HP Digital Entertainment Center is turned on, the S-video and composite jacks will turn off automatically. You must turn off, by pressing and holding down the On/Standby (power) button for 4 seconds, and restart your HP Digital Entertainment Center to ensure Video Out connection to your TV or AV receiver.■ Check your input switches.
My HDTV displays a distorted screen instead of a blank screen (blue or dark). The screen may be cropped or display dark borders.	<ul style="list-style-type: none">■ Refer to http://www.hp.com/support for additional information on adjusting the display or updating the drivers.■ If you see a blank screen, you cannot perform recovery or certain activities with HDMI. Change your Video Out connection to VGA, recover your system, and then reconnect the HDMI connection.■ Connect a monitor to your HP Digital Entertainment Center. See "Video Out to TV and Monitor" on page 68.
The HP Digital Entertainment Center doesn't recognize my digital video camera.	See "Recognizing the digital video camcorder" on page 111.

Problem <i>(continued)</i>	Solution
<p>My remote control doesn't work.</p>	<ul style="list-style-type: none"> ■ Check that the remote control indicator light on the remote lights up when you press a button. If it does not, replace the batteries. ■ Make sure that the batteries for the remote control are charged and installed correctly. ■ Make sure the front of the remote sensor on the HP Digital Entertainment Center is not blocked (behind display window). ■ Point the remote control at the HP Digital Entertainment Center (not at the TV) within a 45-degree angle range, and less than 26 feet (8 meters) away. ■ If a pressed key repeats itself (or sticks), try altering the lighting conditions in the room or moving the location of the HP Digital Entertainment Center. ■ Press the Enter button on the remote control after changing a channel. ■ Point the remote control toward the remote sensor, and press a button. A faint red light should appear on the remote sensor. If the light appears, then the problem is probably in the Media Center software. Close Media Center, restart the HP Digital Entertainment Center, and then open Media Center again. ■ If the remote control works in Media Center but not when changing channels, you need to reconfigure the Media Center software settings for the cable set-top box or satellite receiver. Refer to the <i>HP Digital Entertainment Center Software Guide</i>.
<p>My remote sensor is not receiving a signal from the remote control.</p>	<p>If a faint red light does not appear when you point the remote control at the front panel remote sensor and press a button, try the following:</p> <ul style="list-style-type: none"> ■ Check that the remote control indicator light on the remote lights up when you press a button. If it does not, replace the batteries. <p>Or</p> <ol style="list-style-type: none"> 1 Click Start on the desktop, right-click My Computer, and then select Properties. 2 Click the Hardware tab, and then click Device Manager. 3 Click the plus (+) sign next to Universal Serial Bus Controllers. 4 If the <i>eHome Infrared Receiver</i> is listed under Universal Serial Bus Controllers, Windows is properly detecting the IR receiver. If it is not listed, go to the next step. 5 Turn off the HP Digital Entertainment Center. Remove all external USB devices. Remove the power cord for 30 seconds. Then reconnect external devices and power. Repeat steps 1–4.

System

Find the description that most closely matches your problem, and try the corresponding solution.

Problem	Solution
My HP Digital Entertainment Center won't turn on at all.	<ul style="list-style-type: none">■ When you press the On button on the front of the HP Digital Entertainment Center, the following events should happen:<ul style="list-style-type: none">a The HP On/Standby (power) button should light and the front display should light up.b The hard disk drive and fans spin.c The HP Digital Entertainment Center makes one beep, indicating it is operating properly.■ If the HP Digital Entertainment Center doesn't go through the previous procedure, check the following:<ul style="list-style-type: none">a The power cord and all cables are securely plugged into the HP Digital Entertainment Center.b The power cord is plugged into a grounded outlet. Check to see whether the outlet works by plugging another item into it.c Look inside the rear fan. If you see a green LED, then AC power is available.d The TV or monitor is connected to the HP Digital Entertainment Center, plugged in, and turned on.e Make sure that the HP Digital Entertainment Center is not too hot, and that vents are not blocked.
I installed a new printer or other device, and it won't work.	<ul style="list-style-type: none">■ Be sure that you installed the device drivers that came with the new device.■ You may need an updated driver for Windows XP. For non-HP peripherals, contact the vendor directly. For HP peripherals, visit the HP Web site. Refer to the <i>Warranty and Support Guide</i> for details.

Problem <i>(continued)</i>	Solution
<p>The HP Digital Entertainment Center (or part of it) doesn't seem to be working.</p> <div data-bbox="196 581 467 1020" style="background-color: #76b82a; color: white; padding: 10px; border-radius: 10px; text-align: center;">  <p>Using the On button to reset the HP Digital Entertainment Center is not recommended and should be used only as a last resort.</p> </div>	<ul style="list-style-type: none"> ■ The HP Digital Entertainment Center is in standby mode (the On button power indicator light is solid amber). Press the Standby button on the keyboard or the Standby button on the remote control to turn on the unit. ■ Make sure the keyboard syncs with the HP Digital Entertainment Center. See "Synchronizing the Keyboard" on page 130. ■ Try restarting the HP Digital Entertainment Center as follows: <ul style="list-style-type: none"> a Click Start on the taskbar. b Click Turn Off Computer. c Click Restart. ■ If the HP Digital Entertainment Center shows no response to mouse or keyboard actions, reset the HP Digital Entertainment Center: <ul style="list-style-type: none"> a Press and hold the On button for more than 4 seconds until the HP Digital Entertainment Center turns off. b Wait a few seconds, and turn the HP Digital Entertainment Center back on. ■ A software program, software driver, or the operating system software may be corrupted, erased, or damaged. You can use Application Recovery or System Recovery to reinstall the software. Refer to the <i>Warranty and Support Guide</i> that came with your HP Digital Entertainment Center. ■ It's possible that a voltage spike, power outage, or brownout has occurred. Symptoms of voltage spikes include a flickering video display, unexpected HP Digital Entertainment Center startups, and the HP Digital Entertainment Center not responding to your commands. A voltage spike can occasionally corrupt or destroy files, so it is a good idea to consistently make backup copies of your data files. Prevent voltage spikes by installing a surge suppressor between the power outlet and the HP Digital Entertainment Center power cord.

Problem <i>(continued)</i>	Solution
<p>When I push one of the special or multimedia buttons on the keyboard, nothing happens.</p>	<ul style="list-style-type: none"> ■ Check that the standard keyboard keys and mouse work properly. Or ■ Check the button configuration. <p>To configure the button:</p> <ol style="list-style-type: none"> 1 Click Start on the taskbar, and then click Control Panel. 2 Click Printers and Other Hardware, if it is available. 3 Double-click Keyboard. 4 In the Keyboard Properties window that opens, click the Buttons tab. 5 Double-click the button you want to change. The button configuration window opens. 6 Choose the button capability from the drop-down list. Enter the Display label and the Address information. (For a Web site, enter the complete Web site URL in the Address box.) 7 Click OK and then on the Buttons tab, click Apply. 8 Repeat steps 5 through 7 for each button you want to configure. 9 Click OK when you are finished configuring the keyboard.
<p>My keyboard or the trackball doesn't work even though the HP Digital Entertainment Center and TV or monitor seem to work.</p>	<ul style="list-style-type: none"> ■ Make sure the trackball is clean. If the trackball stops moving easily, the trackball and rollers probably require cleaning. <ul style="list-style-type: none"> a Rotate the trackball-cover ring counter-clockwise to remove the ring and release the trackball. b Rinse the trackball with soap and warm water. c Clean the rollers inside the HP Digital Entertainment Center with a cotton swab dampened with isopropyl alcohol. d Replace the trackball and the trackball-cover ring. ■ Make sure the keyboard syncs with the HP Digital Entertainment Center. See "Synchronizing the Keyboard" on page 130. ■ Try restarting the HP Digital Entertainment Center as follows: <ul style="list-style-type: none"> a Click Start on the taskbar. b Click Turn Off Computer. c Click Restart.

Problem <i>(continued)</i>	Solution
<p>The TV or monitor doesn't work, even though the HP Digital Entertainment Center appears to.</p>	<ul style="list-style-type: none"> ■ Make sure the TV or monitor is turned on — it has its own Power button. ■ Make sure the proper TV or monitor input is selected. ■ Check the cable connection between the monitor and the HP Digital Entertainment Center. The cable connectors must be pushed in all the way prior to powering on the HP Digital Entertainment Center. ■ Ensure that the cables to your monitor and your TV connect to the Video Out connectors on the HP Digital Entertainment Center. ■ Make sure the monitor power cord is plugged into a grounded outlet. Check to see whether the outlet works by plugging another item into it. (If the light on the front of the monitor is lit, the monitor is getting power.) ■ Try restarting the HP Digital Entertainment Center as follows: <ul style="list-style-type: none"> a Click Start on the taskbar. b Click Turn Off Computer. c Click Restart. ■ Adjust the brightness and contrast controls on the monitor.
<p>My software stopped working.</p>	<p>Refer to the <i>Warranty and Support Guide</i> that came with your HP Digital Entertainment Center to reinstall a software program. If your program came on a CD, follow the instructions that came with the software to reinstall it.</p>
<p>I cannot remove a CD or DVD.</p>	<p>You cannot remove a CD or DVD after you have turned off the HP Digital Entertainment Center. Turn on the HP Digital Entertainment Center, and press the Eject button to extend the tray.</p>

Problem <i>(continued)</i>	Solution
<p>The memory card reader won't read my memory cards.</p>	<ul style="list-style-type: none"> ■ The memory card reader is a device that uses the Safely Remove Hardware task. This appears as a Windows system tray icon next to the time. Do <i>not</i> click Stop in the Safely Remove Hardware window. If you do click Stop, the drive is disconnected. If this happens, restart the HP Digital Entertainment Center. ■ Do not insert or remove memory cards when the in-use light is flashing. To do so may cause data loss, or it may permanently damage the card reader. ■ Format a memory card before you use it. Click Start, and then click My Computer. Under Removable Storage, right-click the memory card icon and select Format. Click Start. Click OK on the Format Complete Window, and then click Close to finish. ■ Some cards have a read/write or security switch on the card. Make sure the read/write switch is set to Write Enabled before attempting to write data to it. ■ Make sure the amount of data you are storing has not exceeded the storage limit of the card. ■ Make sure the memory card is one of the supported types: CompactFlash I/II and Microdrive, Memory Stick, Memory Stick Pro, MultiMedia, Secure Digital, SmartMedia, or /xD. ■ Make sure the memory card is fully inserted into the correct slot. ■ Remove the memory card when the light is not flashing, and shine a flashlight into the empty slot. If any of the pins are bent, have the HP Digital Entertainment Center serviced if a pin is touching another pin. ■ Inspect the ends of the memory cards for dirt or material closing a hole or spoiling a metal contact. Clean the contacts with a lint-free cloth and small amounts of isopropyl alcohol. Replace the memory card if necessary.
<p>My video is experiencing errors.</p>	<ul style="list-style-type: none"> ■ Your file may be corrupt or in an unsupported format. Open the video file in a video editor such as WinDVD Creator, and then resave the file in a supported format. ■ There may be a problem with the codec. For more information, look in Windows Media Player Help, and then search for <i>codec</i>.
<p>Codec errors are occurring when I play certain files.</p>	<p>Codec is an abbreviation for compressor-decompressor. A <i>codec</i> is software or hardware used to compress and decompress digital media.</p> <p>If you get a codec error when playing an audio file, open the file in Windows Media Player. Configure Windows Media Player to automatically download codecs. You must be connected to the Internet to download the codec file.</p>

Problem <i>(continued)</i>	Solution
My DVD won't play.	<ul style="list-style-type: none"> ■ You can put data files on a DVD to store them or transfer them to another HP Digital Entertainment Center. However, data files on a DVD do not play in a DVD player. Rerecord your files to a file format that can be read by some DVD players. ■ If you are using component video output, you may need to change the configuration. See "Component Video Settings" on page 60. Refer to http://www.hp.com/support for additional information on using component video. ■ Check your DVD country/region.
My DVD won't play a DVD audio disk.	This format is not supported by the DVD player.
I keep running out of disk space.	<ul style="list-style-type: none"> ■ Burn some big files to DVD and remove them from your hard disk drive. ■ Upgrade your hard disk drive. The hard disk drive is user replaceable.
I am getting disk errors.	<ul style="list-style-type: none"> ■ Run disk recovery. ■ Replace your hard disk drive. The hard disk drive is user replaceable.
My music files don't appear in the Media Library.	<ul style="list-style-type: none"> ■ Make sure you use Windows Media Player to add your music files to the Media Library. ■ Check whether the Windows Media Player setting for access rights of other applications is set to <i>No access</i>. It must be set to <i>Read only</i> or <i>Full access</i> for your music files to appear. Refer to Windows Media Player Help for more information ■ Use supported audio file formats. Refer to the HP Tunes library.



If you need more information about using or troubleshooting Media Center, refer to the Media Center online Help or Help and Support in the Start menu.

Getting Help

Help and Support Center

For help, press the Help button on your keyboard, or click **Start** on the taskbar and select **Help and Support**.



The **Help and Support Center** is onscreen Help information about your HP Digital Entertainment Center. Here you can find:

- Links to reinstall drivers.
- Access to technical support options.
- Answers to commonly asked questions about your HP Digital Entertainment Center.

To open the Help and Support Center:

- 1 Press the **Help** button on your keyboard (the **?** button).

Or

Start Media Center. Click the Help (**?**) icon at the top left of the screen.



Or

Click **Start** on the taskbar, and click **Help and Support**.

HP Support

HP Support provides important support information about your HP Digital Entertainment Center.

Here you can find:

- Your product number, model number, and serial number.
- Registration information and link (monitor, keyboard, and mouse recommended).
- Where to find more information about your HP Digital Entertainment Center.
- An HP Digital Entertainment Center hardware test.
- How to contact HP.

To open HP Support:

- 1 Press Media Center on the remote control.



You can also click **Start** on the taskbar, and select **Media Center**.

- 2 Click **More Programs**, and then **HP Support**.

- 3 Select a program or folder:

- Register Now
- Learn More
- Test Hardware
- Contact HP

Warranty and Support Guide

See the HP Digital Entertainment Center *Warranty and Support Guide*, included with the documentation, for detailed information on:

- HP Web site Support addresses
- HP Support telephone numbers
- HP Customer Care information
- HP Web site Online Guide addresses
- Application and System Recovery programs
- The terms of your HP limited warranty
- License information

HP Web Site Support

The HP Web site provides:

- Supplemental information about the HP Digital Entertainment Center and products
- HP Support contact information
- Software updates
- Software patches
- Online Information and technical support for your HP Digital Entertainment Center
- Online manuals for your HP Digital Entertainment Center

To use the HP Web site:

- 1** Connect to the Internet:
Open your Web browser.
Or
Press Connect on your keyboard.
- 2** Access the HP Support Web site. Type **http://www.hp.com/support** into the Web browser address box. Press Enter.
- 3** Select your country/region from the drop-down list. Press the arrow button next to the list.
- 4** Use the Web site addresses listed in the *Warranty and Support Guide* for information about your HP Digital Entertainment Center and your technical support needs.

HP Customer Care

You can get help over the telephone from HP. When you call HP Customer Care, have your model number and serial number available.

See the keyboard or the *Warranty and Support Guide* for the support telephone numbers.

Online Guides

You can find online guides and information for your HP Digital Entertainment Center. To view online manuals for your HP Digital Entertainment Center, go to the Support Web address that is listed in the *Warranty and Support Guide* that came with your HP Digital Entertainment Center, and then search for your product name and number.

Online manuals are associated with specific HP Digital Entertainment Center model numbers. Some models may not have online manuals.

Application and System Recovery Programs

The HP Digital Entertainment Center uses the operating system and installed software programs during normal operation. If your HP Digital Entertainment Center works improperly or stops because of the software, you may be able to repair it by restarting the HP Digital Entertainment Center, using System Restore, or using other methods including the System Recovery programs.

Two blank DVD-R discs are included with the HP Digital Entertainment Center system. You can use these DVD-R discs to create System Recovery discs that you can use to recover your system.

For instructions on using recovery discs, repairing and recovering your software, and more information, refer to the *Warranty and Support Guide* that came with your HP Digital Entertainment Center.

Problems with software programs may be caused by corruption or damage to an individual program (application or software driver) or to part of the operating system software.

Updates from HP

HP may send updated information or patches to your desktop (not available in all countries/regions). You must be connected to the Internet to receive these updates. If you have turned off the Updates from HP feature, you will not receive these updates.

To turn updates back on:

- 1 Click **Start**, choose **All Programs**, and then **HP Digital Entertainment Center Help & Tools**.
- 2 Click **Updates from HP**, and then click **Re-enable Updates from HP**.

Microsoft Web Site

Search the Microsoft Web site (<http://www.support.microsoft.com>) for Knowledge Base articles and updates on Microsoft® Windows® XP Media Center Edition 2004.

You can also use the Online Spotlight link to get to the Microsoft Windows XP Media Center Web site.

To get the latest news and information about your Microsoft Windows XP Media Center program:

- 1 Press the Media Center button on your remote control. 
- 2 Select **Online Spotlight** from the Media Center Start menu.

Replacing the Hard Disk Drive

Safeguarding Recorded TV programs

When you replace the hard disk drive, you lose any files or software that you created, saved, or installed on the HP Digital Entertainment Center. Because of this, you also lose a special code that Microsoft includes in the files of recorded TV programs. Without the code, Media Center cannot play TV programs previously recorded to disk or copied to DVD or to other media.

For more information about safeguarding your recorded TV programs, refer to the *HP Digital Entertainment Center Software Guide*.

Before Replacing the Hard Disk Drive

Replace the internal hard disk drive only if it has failed. Do not replace the internal hard disk drive until HP support has diagnosed it as the point of failure. HP recommends that you upgrade the hard disk drive capacity by using the HP Personal Media Drive.



Only advanced users should attempt to perform this procedure.

Before you begin to replace the internal hard disk drive:

- 1** Make sure you have the recovery discs (DVDs) you created with the two blank DVD_R discs that came with your HP Digital Entertainment Center.
- 2** Back up your data to the Personal Media Drive or burn it to DVD.
- 3** Close Media Center and all other programs that may be accessing the hard disk drive.
- 4** Turn off the HP Digital Entertainment Center.
- 5** Disconnect the power cable from the HP Digital Entertainment Center.
- 6** Disconnect all other cables from the HP Digital Entertainment Center.

Removing the Hard Disk Drive

To remove the internal hard disk drive:

- 1 Gently turn the HP Digital Entertainment Center upside down.
- 2 Remove the hard disk drive cover from the chassis. After loosening the screw (A), slide the hard disk drive in the direction of the screw (B).

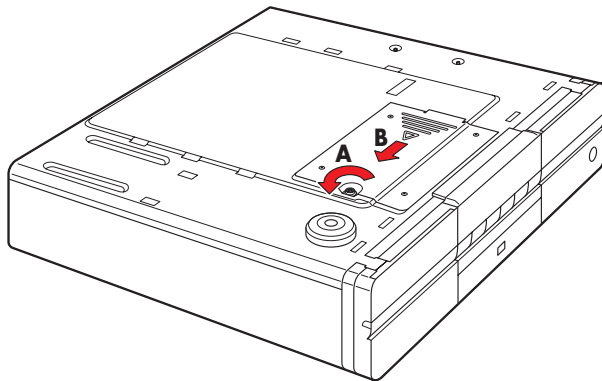

- 3 Lift up the hard disk drive from the chassis.

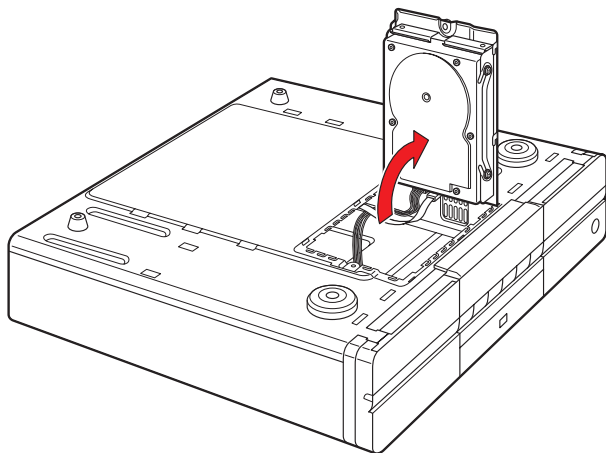

- 4 Disconnect the hard disk drive cables.

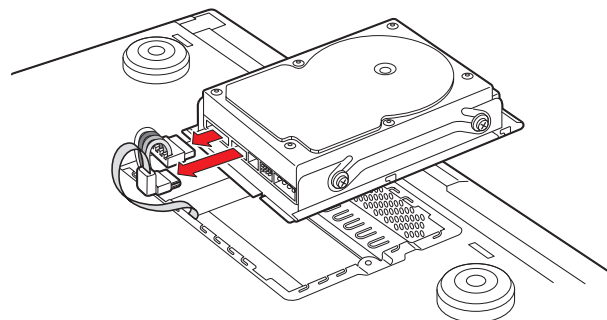

- 5 Remove the four hard disk drive screws (A) and then remove the hard disk drive (B).

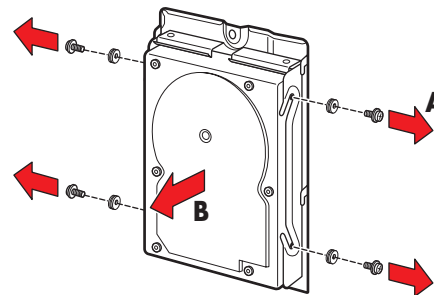

Replacing the Hard Disk Drive

To replace the internal hard disk drive:

- 1 Replace the old hard disk drive with the new hard disk drive (**A**).
- 2 Replace the four hard disk drive screws (**B**). Tighten the screws an additional half-turn only after the screws contact the rubber washer.

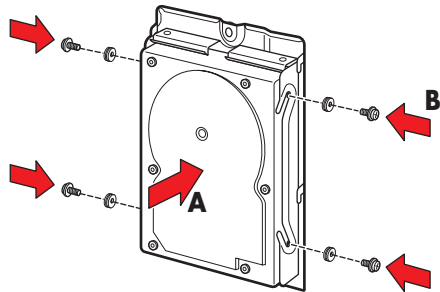

- 3 Reconnect the hard disk drive cables.

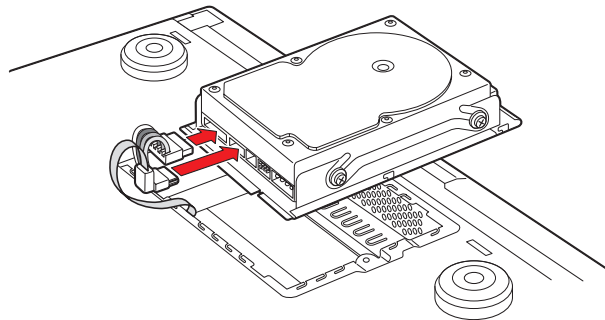

- 4 Place the hard disk drive into the chassis. Position the metal tabs.

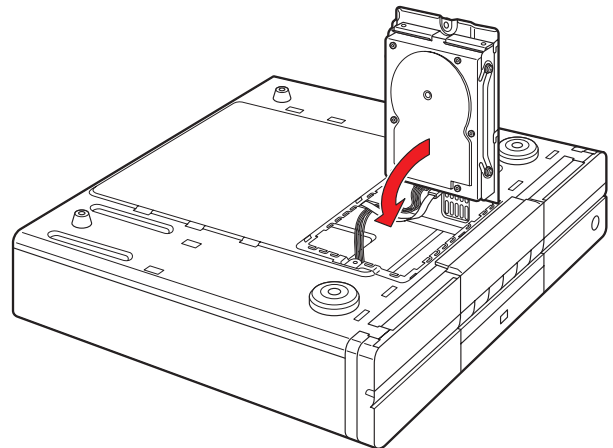

- 5 Replace the hard disk drive cover on the chassis. Slide the cover away from screw (**A**) and then tighten the screw (**B**).

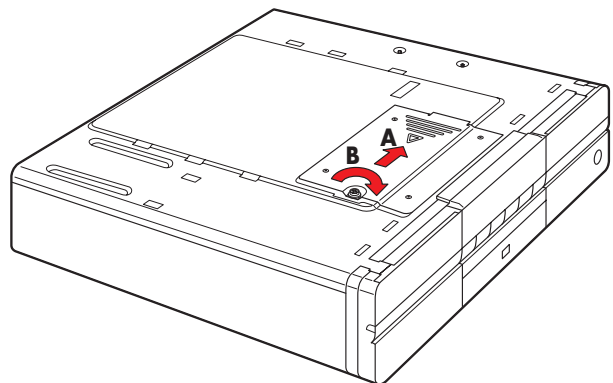

- 6** Gently turn the HP Digital Entertainment Center right side up.
- 7** Reconnect all cables to the HP Digital Entertainment Center. Reconnect the power cable last.
- 8** Turn on the HP Digital Entertainment Center.
- 9** Test the HP Digital Entertainment Center for proper operation.
- 10** Recover your system using the recovery disk.
- 11** Restore your data.

Index

Numerics

- 1/4 inch headphones 135
 - 1394 7, 109
 - 2.0 multichannel audio system 41
 - 2.1 home stereo installation 41, 42
 - 2.1 multichannel audio system 42
 - 2.1 powered speaker 49
 - 4.1 Home Theater Audio 43
 - 4.1 powered speaker 50
 - 5.1 home theater audio 44
 - 5.1 multichannel audio system 44
 - 5.1 powered speaker 51
 - 5/4.1 home audio installation 43
 - 7.1 Home Theater Audio 45
 - 7.1 multichannel audio system 45
 - 7.1 powered speaker 52
 - 802.11 b/g 117
 - 9-in-1 card readers 5
- ## A
- active (powered) speakers 48
 - Additional equipment 32
 - adjusting
 - desktop display resolution 143
 - front panel brightness 134
 - speaker volume 136
 - Adjusting the Volume 136
 - Alt+F5 140
 - Analog Camcorder 112
 - Antenna (ATSC) 81
 - Antenna (NTSC and ATSC) 82
 - Antenna Connection 80
 - for FM radio 56
 - antennaweb.org 73
 - Application and System Recovery 172
 - Application Recovery 154
 - ATSC 73, 74
 - antenna 73
 - from VHF/UHF antenna 78
 - HDTV Channels 148

- Audio 7.1 Pre-Out 6
- audio configuration 135
- Audio Connection
 - Typical 38
- audio files
 - codec errors 168
 - do not appear in Media Library 169
- Audio Output 138
- Audio Problems and Solutions 160
- audio settings 138
- Audio system equipment 32
- Audio/Video flow 21

B

- back panel
 - location of connections 6
 - system diagram 22
 - video connector locations 76
- Basic Setup 27
- Basic TV audio setup (2.0) 39
- batteries 13
 - installing in keyboard 128
 - installing in remote control 16
 - replacing in keyboard 13
 - type
 - for keyboard 13
 - for remote control 16
- before you start
 - additional items necessary 32
 - cables you may need 31
 - components supplied 29
 - safety information 17
- Benefits 2
- Brightness 134
- brightness, adjusting front panel display 134
- broadband Internet 113
- Broadband Internet equipment 32
- button functions, remote control 14
- buttons
 - configuring keyboard 150

C

- Cabinet back 26
- Cabinet Front 25
- Cable (NTSC) and UHF Antenna (ATSC) 83
- cable box 71
- cable modem 119, 120
- cable modem, connecting 119
- Cable Only (NTSC) 88
- cable receiver
 - dual tuner option 72
 - setting up using Media Center 132
- Cable/Antenna In 8
- cables
 - included 30
 - not included 31
- Camcorder 101, 104
- camera
 - connecting digital still 121
 - connecting digital video 109
- capture 112
- Center/Subwoofer 6
- Changing screens 140
- clearances, space for HP Digital Entertainment Center 28
- cloning 140
- Coaxial Splitter 31
- codec errors 168
- combination of Video 68
- CompactFlash I/II 5
- component video 60
- Component Video Out 7
- Component Video Settings 60
- composite 75
- Configuring Audio 135
 - for Media Center 139
 - for the DVD player 139
- configuring Media Center
 - audio settings 138
 - for cable or satellite receiver 132
 - for DVD player 139
 - for multichannel audio 139
 - for optional display 132
 - for your speaker setup 132
 - for your TV tuner and program guide 132
 - front panel display brightness 134
 - selecting recording devices 136
- Configuring the Keyboard Buttons 150
- Configuring the System 150
- Configuring Video 140
- Configuring Video Output and Source 140
- Connecting
 - headphones 135
 - TV Audio 39
 - VCRs 101
- connecting
 - 2.0 speaker system 41
 - 2.1 speaker system
 - with passive speakers 42
 - with powered speakers 49
 - 4.1 speaker system
 - with passive speakers 43
 - with powered speakers 50
 - 5.1 speaker system
 - with digital input on AV receiver 46
 - with digital speakers 53
 - with passive speakers 44
 - with powered speakers 51
 - 7.1 speaker system
 - with passive speakers 45
 - with powered speakers 52
- antenna, broadcast TV 80, 81, 82
- cable boxes, two 86, 91
- digital audio to AV receiver 46
- DSL/cable modem 119
- DVD player 103
- microphone 135
- monitor speakers 54

- powered speakers 48
- router, to Internet through 119
- satellite receiver, one 93
- satellite receivers 95
- tape player using Audio In connections 55
- TV displays 58
- TV to watch one channel and record on another 72
- VCR with direct connections 105
- video analog camera 112
- video digital camera 109
- video, overview 104
- Connections 20
 - system diagram 22
- Connections Don't Work 133
- connector locations
 - for audio output 34
 - for video output 59
 - on back panel 6
 - on front panel 3
- contacting HP
 - Customer Care by telephone 172
 - using the Web 171
- Customer Care 172
- D**
- data files on DVDs, troubleshooting 169
- Desktop Display 148
- Desktop resolution 60
- Device Manager 111
- Digital 5.1 multichannel audio system 47
- digital audio cable 46
- digital audio system 53
- digital audio, 5.1 supported formats 46
- Digital home theater audio 46
- Digital powered speaker 53
- Digital Speakers 53
 - connecting 53
- Digital Still Camera 121, 122
 - connection 121
- Digital TV for Windows 74
- Digital Video Camcorder 109
 - back panel 110
 - front panel 110
- Digital Video Camera 122
- disconnect the TV 143
- Display Overview 60
- Display/video configuration 62
- documentation
 - how to find HP support information 171
 - how to find online manuals 172
- Dolby Digital 46
- DSL 119, 120
 - connecting 119
 - order of powerup 17
- DTS Digital encoded audio 46
- DTV 74
 - channels 148
- dual displays 60
 - configuring with Media Center 132
 - disabling 142
 - switching between 140
- Dual-tuner 72
- DVD audio setting 138
- DVD playback 60
- DVD player 103
 - configuring audio settings 138
 - configuring using Media Center 139
 - location of connectors 103
 - troubleshooting 169
 - use with data files 169
- E**
- error messages
 - codec error when playing certain files 168
 - from hard drive 169
- Ethernet 7
- External hard disk drive 122

- F**
- FAQs, how to find 170
 - Fast Ethernet (100BaseT) 116
 - feature overview 2
 - Finding ATSC HDTV and Standard TV Channels 148
 - FireWire (IEEE 1394) 109
 - FireWire input-output, location on front panel 4
 - flashlight 99
 - FM Antenna, connecting 56
 - FM radio antenna 56
 - Found New Hardware 121
 - Front 3, 6
 - Front Panel 3, 23, 153
 - Front Panel Display Brightness 134
 - front panel, adjusting display brightness 134
- G**
- Getting Help 170
 - Gigabit Ethernet (1000BaseT) 116
 - Guide, Television Program 148
- H**
- hard drive
 - connecting HP Personal Media Drive 123
 - location on front panel 3
 - replacing 176, 177
 - running out of disk space 169
 - troubleshooting 169
 - Hardware 111
 - hardware test, for HP Digital Entertainment Center 170
 - HDTV 74
 - antenna 73, 81
 - channels 75
 - HDTV (ATSC) In 8
 - HDTV and standard signal source — TV antenna 82
 - HDTV/SDTV Ant. In 77
 - headphones 135
 - location of output on front panel 4
 - help
 - how to find 170
 - Microsoft Web site 173
 - Help and Support Center 170
 - High definition capable plasma, LCD, or HDTV display 58
 - high-definition TV 73
 - how to configure Media Center
 - for cable or satellite receiver 132
 - for optional display 132
 - for your speaker setup 132
 - for your TV tuner and program guide 132
 - how to connect
 - 2.0 speaker system 41
 - 2.1 speaker system
 - with passive speakers 42
 - with powered speakers 49
 - 4.1 speaker system
 - with passive speakers 43
 - with powered speakers 50
 - 5.1 speaker system
 - with digital input on AV receiver 46
 - with digital speakers 53
 - with passive speakers 44
 - with powered speakers 51
 - 7.1 speaker system
 - with passive speakers 45
 - with powered speakers 52
 - broadcast antenna 80, 81, 82
 - cable boxes, two 86, 91
 - camera, digital still 121
 - camera, digital video 109
 - digital speakers 53
 - DSL/Cable modem 119
 - DVD player 103
 - FM radio 56
 - HP personal media drive 124
 - monitor speakers 54
 - powered speakers 48
 - remote IR 99
 - router, to a LAN through 120
 - satellite receiver, one 93
 - satellite receivers, two 95
 - USB devices 122
 - VCR 105

- how to find
 - FAQs 170
 - help 170
 - HP Digital Entertainment Center hardware test 170
 - utility programs 153
- how to obtain updates 173
- how to register for updates 151
- how to replace
 - batteries in keyboard 13
 - batteries in remote control 16
 - hard drive 176, 177
- how to switch
 - inputs using your monitor 68
- how to switch between audio and video
 - using your monitor 67
 - using your receiver 65
 - using your TV 63
- how to switch between dual displays 140
- how to synchronize, the keyboard 130
- how to transfer PC data to HP Digital Entertainment Center 152
- HP Customer Care 172
 - contacting by telephone 172
- HP Digital Entertainment Center
 - box contents 29
 - recovery after a power outage 165
 - reset procedure 165
 - support for 170
- HP Help and Support Center 170
- HP Media Drive 124, 153
- HP Personal Media Drive 123
 - automatic on and off feature 123
 - disconnecting 125
 - installing 124
 - running the media drive utility 124
 - utility 124
- HP Settings 153
- HP Support 170
- HP Web site 171
- HP Web Site Support 171

- I**
 - Indicator light 10
 - Infrared Transmitter 97
 - Infrared Transmitter cable 99
 - Infrared Transmitter connection (one set-top box) 98
 - Infrared Transmitter connection (two set-top boxes) 98
 - Infrared Transmitter Installation 99
 - Infrared Transmitter sensor 99
 - Initial Configuration 127
 - initial Microsoft Windows setup screen 131
 - Initial Setup Wait Time 131
 - Installation Overview 19
 - installing
 - additional software and devices 153
 - batteries in keyboard 16
 - batteries in remote control 128
 - HP Personal Media Drive 124
 - software 153
 - internal splitter 77
- Internet
 - connecting DSL/cable modem 119
 - connecting through a router 120
 - connection 117
 - service contract 117
 - typical configurations 116
- IR Blaster 97
- irrecoverable data loss ii
- K**
 - keyboard 122
 - batteries (Initial) 128
 - buttons 150
 - configuring buttons 150
 - function keys 10
 - replacing batteries 13
 - synchronizing 130, 166
 - troubleshooting 130, 166
 - Keyboard Connect button 12, 130

L

LAN 117, 120

LED 5

light-emitting diode (LED) 5

location 24

M

Media Center

adjusting desktop display resolution 143

configuring audio settings 138

dual displays option

disabling 142

enabling 141

Microsoft Web site 173

obtaining update information 173

registering for updates 151

testing system connections 133

utility programs 153

viewing on a second display 141

Media Center First Run 132

Media Center speaker settings 138

Media Center TV Program Guide 148

Media Center wizard 133

Media Library

music files not displaying 169

troubleshooting 169

memory card reader

location of slots on front panel 5

troubleshooting 168

Memory Stick (MS) 5

Microdrive 5

microphone 135

connecting 135

location of inputs on front panel 4

Microsoft Web site 173

information about Media Center 173

microsoft.com 74

MMC/SD 5

monitor 58

connecting 68

troubleshooting 167

Monitor Out 67

monitor speakers 54

Mouse 122

Mouse button 10

moving your files 152

MP3 player 122

MS/MS-Pro 5

MultiMediaCard 5

multiple audio/video inputs 63

N

network 113

connections 116

connections supported 113

connectors

location on back panel 115

on back panel 114

equipment 113

notes ii

NTSC 72, 74

analog cable 78

cable 79

from VHF/UHF antenna 78

satellite 79

NTSC cable and ATSC antenna 78

NTSC cable and ATSC VHF/UHF antenna 83

nVidia

dual display 141, 142, 146, 149

O

On/Standby 10

On/Standby (power) button 129

One Cable Box (NTSC) and Antenna (ATSC) 84

One Cable TV box 89

One Cable TV or Digital Cable box (NTSC) 90

one satellite receiver 94

Online Guides 172

Online Spotlight 173

accessing using Media Center 173

Open cabinet 25

open-back 24

optical cords 46

Optional set-up 132
 overview
 connecting audio devices 34
 connecting video equipment 104
 features 2
 TV signal source 72
 video input connections 75
 video out connections 58

P

PC Doctor 154
 PC Help & Tools 154
 PC System Recovery 154
 PDA 122
 Performance and Maintenance 111
 Peripheral Connection 114
 peripheral devices 122
 Personal Media Drive 123
 pixels 148
 Placement 25
 power outage, recovery from 165
 Powered speakers 48, 54
 premium channels 75
 printer 122
 connecting 122
 troubleshooting 164
 problems 159
 Problems and Solutions 160
 Product features 2
 Program Guide, Television 148
 Progressive scan 60

R

receiver/amplifier 40
 Recognizing the camcorder 111
 Recorded TV Programs 175
 recording devices 136
 configuring with Media Center 136
 recovery disc
 as used after replacing hard drive 178
 supplied 29
 recovery discs 172
 recovery programs, using 154
 registering for updates 151
 Registering with HP 151
 remote control 61, 97
 button functions 14
 installing batteries 16
 maximum range 16
 troubleshooting 163
 using with your TV 61
 Remote Control Batteries 16
 Remote Control Buttons 14
 remote IR transmitter cable connection
 connecting 99
 importance of placement 97
 location 98
 relation to cable box and satellite receiver 97
 troubleshooting 163
 remote receiver 97
 remove the HP Personal Media Drive 125
 removing
 CD/DVD 167
 personal media drive 123
 replacing
 batteries in keyboard 13
 batteries in remote control 16
 hard drive 176, 177
 Replacing the Hard Disk Drive 175
 Required Setup 132
 requirements, network connections 113
 reset procedure, HP Digital Entertainment Center 165
 resolution 60
 resolution, adjusting desktop display 143
 retail VHS tapes 105
 RJ-45 119
 router 120
 Router Internet connection 120
 router, connecting to 120

- S**
- Safely Remove Hardware wizard 123
- safety information 17
- satellite receiver 71, 93
 - connecting one unit 93
 - connecting two units 95
 - dual tuner option 72
 - setting up using Media Center 132
- Scan for hardware changes 111
- Scanner 122
- scanner
 - connecting 122
- SDTV 74
- second display 141
- select recording device 136
- sensor, remote IR transmitter cable connection, connecting 99
- set-top box 75
- Setup 27
- signal conversion 75
- Signal Source 72
- Single-tuner 72
- SmartMedia (SM) 5
- SmartMedia/xD 5
- software 127, 153
- speaker types, supported 35
- speaker volume 136
- speakers
 - 2.0 system setup 41
 - 2.1 system setup
 - with passive speakers 42
 - with powered speakers 49
 - 4.1 system setup
 - with passive speakers 43
 - with powered speakers 50
 - 5.1 system setup
 - with digital speakers 53
 - with passive speakers 44
 - with powered speakers 51
 - 7.1 system setup
 - with passive speakers 45
 - with powered speakers 52
 - configuring audio settings 138
 - configuring using Media Center 132
 - connecting monitor speakers 54
 - testing using Media Center 139
 - troubleshooting surround sound 161
 - troubleshooting volume problems 160
- Standard definition television 58
- Start Here booklet 19
- Starting the HP Digital Entertainment Center for the First Time 128
- subwoofer
 - for digital speaker setup 53
 - for monitor speaker installation 54
- support for HP Digital Entertainment Center 170
- supported
 - 5.1 digital audio formats 46
 - network connection types 113
 - speaker types 35
- surge protector 32, 129
- Surround 6
- Surround Back 6
- surround sound, troubleshooting 161
- S-video 75
 - adapter 75
 - connection requirements 58
 - jack and cable compatibility 103
 - location on front panel 4
 - to composite adapter 102
- Switching 61
- switching
 - between dual displays 140
- switching audio video
 - using your monitor 67
 - using your receiver 65
 - using your TV 63
- synchronizing the keyboard 130, 166
- Syncing the Keyboard 130
- system components, inventory of 29

System Integration 20
 System Problems and Solutions 164
 System Recovery 172
 System Restore 154, 172
 System utilities 154

T

tape player
 connecting 55
 Television Program Guide 148
 testing
 audio settings using Media Center 139
 system connections using Media Center 133
 Titan TV 148
 transfer wizard 152
 transferring data from PC to HP Digital Entertainment Center 152
 troubleshooting 159
 audio problems 160
 DVD player 169
 hard drive 169
 keyboard 166
 memory card reader 168
 monitor 167
 music files 169
 power up of HP Digital Entertainment Center 164
 printer 164
 remote control 163
 remote sensor 163
 removing CD/DVD 167
 speaker volume 160
 special keyboard buttons 166
 surround sound 161
 system connections using Media Center 133
 TV problems 162, 167
 unexpected startups 165
 video errors 168
 tuner configurations 72
 Tuning the Desktop Display for S-video and Video (Composite) Connections 148

turning on
 location of power button 3
 troubleshooting 164
 TV
 adjusting desktop display resolution 143
 antenna 80
 Audio Connection 39
 configuring with Media Center 132
 disconnecting 143
 Program Guide 148
 Source 71
 Source Connectors 75, 76
 Titan 148
 troubleshooting 162, 167
 viewing PC image on a second TV 141
 TV and Monitor Out 69
 TV Out (through AV receiver) 66
 TV Source 1 In 7
 TV Source 2 In 8
 TV Source In 71
 Two Cable Boxes (NTSC) and Antenna (ATSC) 86
 Two Satellite Receivers 95
 two screens 140

U

UHF 73
 Updates from HP 173
 upmix 46, 52
 USB 121
 USB 2.0 7
 USB 2.0 connectors 5
 USB device
 connecting 122
 USB device connection 122
 USB drive 122
 utility programs 153
 location 153

V

- VCR 101, 104
 - connecting 105
 - Direct in 105
- Ventilation 25
- VGA Out 7
- VHF 73
- VHF Antenna (NTSC) 80
- video analog camera, connecting 112
- Video Camera 109
- video configuration 140
- video digital camera
 - connecting 109
 - FireWire connection 4
 - troubleshooting connections 162
- video display flickering 165
- Video Equipment 32
 - Connections 104
 - Overview 102
- video image 149
- video input 112
- Video Out 58
- Video Out Connectors 59, 62
- Video out to high-definition capable HDTV 64
- Video out to standard TV 64
- Video Out to TV 63
- Video Out to TV and Monitor 68
- Video Problems and Solutions 162
- video projector 63
- video system
 - errors 168
 - location of output connectors 58
- Viewing the HP Digital Entertainment Center image on the TV 140
- virus protection 151
 - need for 151
- volume icon 137
 - locating on task bar 137
- volume of speaker, adjusting 136

W

- Wall clearance 26
- wall outlet 129
- Wall to set-top box VCR to TV 108
- Wall to VCR to TV 106
- warnings ii
 - against removing media while LED is blinking 5
 - disconnecting disk drive while it is operating 125
 - loss of recorded programs 175
 - moving personal media drive while it is operating 123
 - order of power connection 17
 - use of correct AC power source 17
- Warranty and Support Guide 171
 - about 171
- Web address
 - for Media Center information 173
 - for registering your HP Digital Entertainment Center 151
- Web site support, HP Customer Support 171
- Welcome 1
- Wi-Fi accessory box 118
- Wi-Fi antenna 118
- Windows Welcome 131
- Wireless access point 117
- wireless keyboard, location of LED 4
- Wireless LAN 7, 117
- Wireless network 117
- Wireless or Ethernet (10BaseT) 116
- wireless router 117

X

- xD media 5
- XP Media Center Edition 2005 74

Y

- Y adapter cables 48
 - required for speakers 48
- Y, Pb, Pr 58
- Y/C video 77

Part Number: 5991-6292

Free Manuals Download Website

<http://myh66.com>

<http://usermanuals.us>

<http://www.somanuals.com>

<http://www.4manuals.cc>

<http://www.manual-lib.com>

<http://www.404manual.com>

<http://www.luxmanual.com>

<http://aubethermostatmanual.com>

Golf course search by state

<http://golfingnear.com>

Email search by domain

<http://emailbydomain.com>

Auto manuals search

<http://auto.somanuals.com>

TV manuals search

<http://tv.somanuals.com>