

HP

Brio BA410

Business PCs *



Table of Contents

Setting Up Your HP Brio

Unpacking the PC and Monitor	2
Connecting Devices to Your HP Brio PC	3
Comfort and Safety Checklist.	6

Getting Started with Your HP Brio

Starting Your HP Brio	10
Setting Up Windows.	10
Waking Your HP Brio from a Sleep State	11
Stopping Your HP Brio	11
Your PC's Desktop	12
HP Brio Center-Your Desktop Assistant	13
Using Your Software	16
Finding Information on the Web	16
Securing Your HP Brio	16

If You Have a Problem

What to Do First.	18
My HP Brio Doesn't Start Properly	19
My HP Brio Isn't Working Properly	21
What Kind of Problem Is It?	22

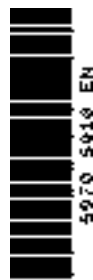

Hardware Problems	23
Software Problems	31
My HP Brio Has an Audio (Sound) Problem	33
My HP Brio Detects an Error at Startup	35
Frequently Asked Questions	41
Need More Help?	41
HP Hardware Diagnostics (e-DiagTools)	42
HP Brio Assist CD-ROM	43
Support and Information Services	45

Upgrading and Replacing HP Brio Hardware

Important - Before You Start	48
Inside the Computer	48
Accessing Internal Components	49
Replacing the System Board	55
Cables and Connectors in Your PC	57
Replacing a Processor	58
Replacing the Floppy Drive	59
Replacing the Hard Drive	60
Installing an Expansion Bay Drive	62
Installing a Memory Module	65
Installing an Expansion Card	66
Replacing the Power Supply Unit	67
Replacing the Battery	69

Technical Information

HP Setup Program	72
Clearing Your PC's CMOS (BIOS) Settings	74
Your PC's BIOS	76
Technical Characteristics	77

Regulatory, Warranty and Support

Regulatory Information.....	80
Recycling your PC	85
HP Hardware Warranty	86
HP Software Limited Warranty.....	94
HP Software License Agreement	95
International Warranty	97
HP Year 2000 Warranty.....	97
HP Customer Care Center Phone Numbers	98
Other Services	99

Important Safety Information

For your safety, never remove the PC's cover without first removing the power cord and any connection to a telecommunications network. Always replace the cover before switching the PC on again.

For your safety, always connect equipment to a grounded electrical wall outlet. Always use a power cord with a properly grounded plug, such as the one provided with the equipment, or one in compliance with your national safety standards. The equipment can be disconnected from the power by removing the power cord from the power outlet. This means the equipment must be located close to an easily accessible electrical outlet.

To avoid electrical shock, do not open the power supply. There are no user-serviceable parts inside.

There is a danger of explosion if the battery is incorrectly installed. For your safety, never attempt to recharge, disassemble or burn an old battery. Only replace the battery with the same or equivalent type, as recommended by the manufacturer. The battery in this PC is a lithium battery that does not contain any heavy metals. Nevertheless, in order to protect the environment, do not dispose of batteries in household waste. Please return used batteries either to the shop from which you bought them, or to the dealer from whom you purchased your PC, or to HP, so that they can either be recycled or disposed of in the correct way. Returned used batteries will be accepted free of charge.

Do not attempt to connect this product to the phone line during a lightning storm. Never install telephone jacks in wet locations unless the telephone line has been disconnected at the network interface. Never touch uninsulated telephone wires or terminals unless the telephone line has been disconnected at the network interface. Use caution when installing or modifying telephone lines. Avoid using a telephone (other than a cordless type) during a lightning storm. There may be a risk from lightning. Do not use the telephone to report a gas leak in the vicinity of the leak. Never touch or remove the communications board without first removing the connection to the telephone network.

Use minimum N° 26 AWG wire for telephone cable.

Choosing a Comfortable Workspace

Choose a workspace for your computer near a grounded electrical wall socket. If your monitor has a tilt-swivel base, attach it to the monitor as described in the monitor manual. Position the monitor on your desk. Position the computer to allow proper ventilation and access to the cables.

WARNING

If you are in doubt that you can lift the equipment safely, do not try to move it without help.

HP Brio Information Roadmap

HP Brio Guide



The *HP Brio Guide* (this manual) will help you:

- Set up and begin using your HP Brio PC for the first time
- Troubleshoot your PC
- Upgrade and replace components in your PC
- Find out where to get more information.

Your PC's Online HP Brio Center

HP Brio Center - for information on:



- Using your PC
- Using Windows
- Fixing problems with your PC.

Refer to “HP Brio Center-Your Desktop Assistant” on page 13 for more information.

Information on the HP Brio Support Web Site



Refer to the HP Brio support web site (www.hp.com/go/briosupport) for a wide range of information, including:

- Downloadable documentation
- Service and support options
- The latest versions of drivers and utilities
- BIOS updates
- Answers to Frequently Asked Questions.

HP Brio Assist CD-ROMs



Used for a full system recovery or alternative OS installation. Includes instructions on how to recover your preloaded software including operating system, drivers and utilities.

Notice

The information contained in this document is subject to change without notice.

Hewlett-Packard makes no warranty of any kind with regard to this material, including, but not limited to, the implied warranties of merchantability and fitness for a particular purpose. Hewlett-Packard shall not be liable for errors contained herein or for incidental or consequential damages in connection with the furnishing, performance, or use of this material.

This document contains proprietary information that is protected by copyright. All rights are reserved. No part of this document may be photocopied, reproduced, or translated to another language without the prior written consent of Hewlett-Packard Company.

Adobe™ and Acrobat™ are trademarks of Adobe Systems Incorporated. Microsoft®, MS-DOS®, Windows® and Windows NT® are U.S registered trademarks of Microsoft Corporation.

Hewlett-Packard France
Business Desktop Division
38053 Grenoble Cedex 9
France

© 2000 Hewlett-Packard Company

Important Ergonomic Information

Improper and prolonged use of keyboards and input devices are among those tasks associated with repetitive strain injury (RSI) to soft tissues in the hands and arms. If you do experience discomfort or pains while using any computing equipment, discontinue use immediately and consult your physician as soon as possible.

Your comfort and safety are our primary concern. Consequently, we strongly recommend that you read HP's ergonomic information before using your PC. For detailed information, refer to HP's online version of "Working in Comfort" which is preloaded on your PC's hard disk or visit HP's Working in Comfort Web site at: www.hp.com/ergo/. A summary is provided in the Comfort and Safety Checklist on page 6.

Setting Up Your HP Brio

This chapter describes how to set up your HP Brio PC.

Unpacking the PC and Monitor.....	page 2
Connecting Devices to Your HP Brio PC	page 3
Comfort and Safety Checklist.....	page 6

Unpacking the PC and Monitor

Remove the HP Brio and the monitor from their boxes. For a basic configuration, you will find the items shown here. You may also have some optional items not shown here. Your monitor may be different from the one shown here.

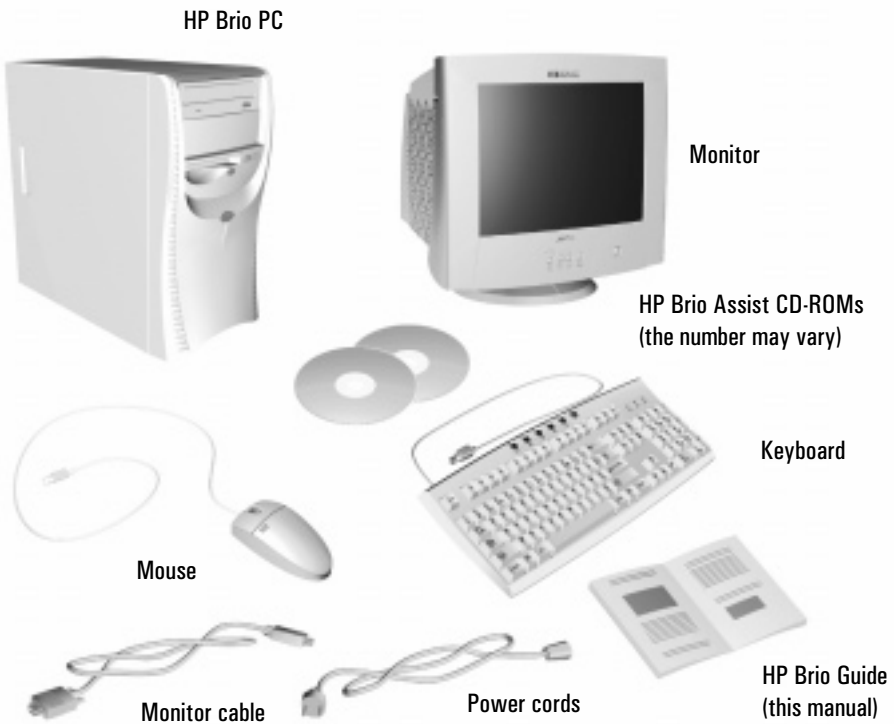

Note: this example shows an HP Brio BA410 PC with a basic configuration and monitor (provided separately)

Connecting Devices to Your HP Brio PC

Caution Check that the correct power supply voltage is selected for your country (the voltage is set during manufacturing and should already be correct).

Before starting up the PC, connect devices and power cords to the rear of the PC as shown below:

The connectors are color-coded for easy matching. Match the colors. *The connectors are shaped to go in one way only.*

Connecting a Mouse, Keyboard, Power Cords and a Monitor.

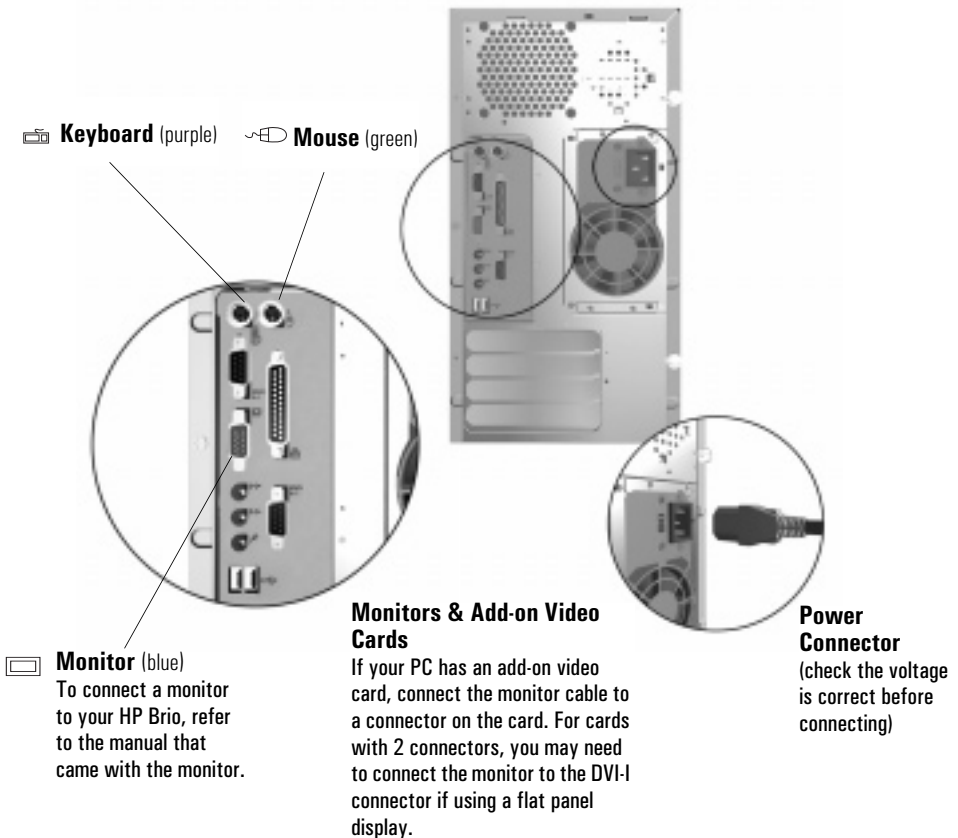

Connecting Other Equipment

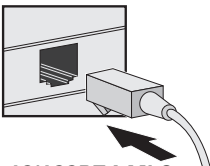
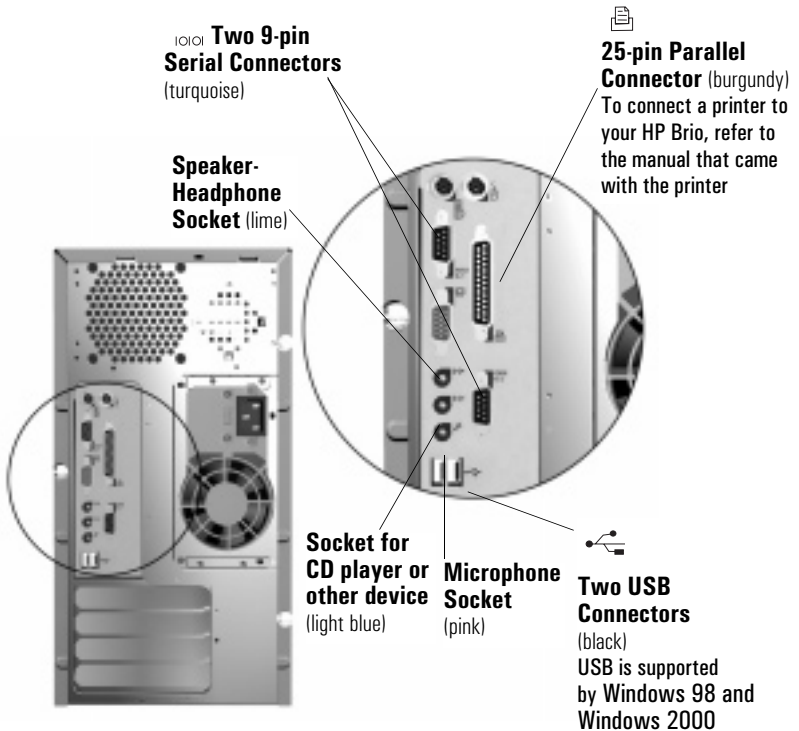

10/100BT LAN Connector

If your PC has an integrated LAN facility, connect the network cable to the PCI LAN card as shown here

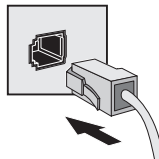

Internal PCI Modem Connector

If your PC has an integrated modem facility, connect the telephone cable both to the telephone wall socket and to the modem card as shown here. Some modems also have a second socket to connect the card to your telephone

WARNING

Always turn the volume down before connecting headphones or speakers to avoid discomfort from unexpected noise or static. Listening to loud sounds for prolonged periods of time may permanently damage your hearing. Before putting on headphones, place them around your neck and turn the volume down. When you put the headphones on, slowly increase the volume until you find a comfortable listening level. When you are able to hear comfortably and clearly, without distortion, leave the volume in that position.

Setting the Country for Your Modem

You must ensure the country setting for your modem is correct. The country is set to match the country you select when configuring your operating system. In some cases, however, the modem may not correctly identify a corresponding country profile. In such cases, reselection may be required to match your exact location.

Checking Settings for the 56K V90 External USB Modem

To check the current settings:

- 1 From the Windows taskbar, click **Start** ⇒ **Settings** ⇒ **Control Panel**.
- 2 Double-click on the **Modem Country Select** icon.
- 3 Change the country setting if necessary.

Checking Settings for the 56K V90 Internal PCI Modem

To check the current settings:

For Windows 98 Users

- 1 Right-click on the **My Computer** icon and select **Properties**.
- 2 Select the **Device Manager** tab and double-click on **Modem**.
- 3 Select the modem model and click on **Properties**.
- 4 Click the **Country Select** tab. The current country setting is marked by an asterisk. Change the country setting if necessary.

For Windows 2000 and Windows NT 4.0 Users

The modem country settings are configured automatically depending on the country setting chosen for your operating system.

Comfort and Safety Checklist

Before using your new HP Brio PC, ensure that your working environment is correct.

Preparing Your Work Environment

When using HP computing equipment, it is important that your work environment contributes to your comfort and productivity:

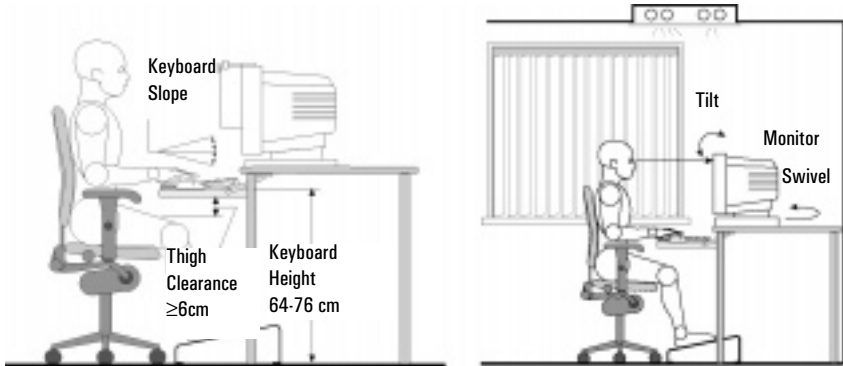

- *Work Surface Height* - Your work surface should be height adjustable. To ensure that your worksurface is at the correct height, first adjust the height of your chair so that your feet are firmly on the floor, then adjust the work surface height until your forearms are parallel to the floor when you have your fingers on the keyboard or other input devices.
- *Chair* - Your chair should provide a comfortable sitting position including features such as a height and tilt adjustment feature, curved seat edge, a stable base (for example, five legs and castors, adjustable back support, a freely rotating swivel, fully adjustable padded arm rests).
- *Monitor* - Place your monitor so that the top of the screen is at, or slightly below, eye level (up to 15 degrees).
- *Work Surface Arrangement* - Make sure that all elements of your HP Brio system for example, monitor, document holder, keyboard, mice and other input devices, and headphones and speakers- are optimally arranged and adjusted to meet your personal requirements. For example, if you are primarily using the keyboard, place it directly in front of you, not to the side. If your work involves extensive use of a mouse or other pointing device, place that device directly in front of

your left or right arm. If you are using both a mouse and keyboard, place them both at the same work surface height and close together. If a palm rest is used, the height should be flush with the front edge of the keyboard. Other items, such as your telephone or notepad, should also be considered.

Caution Various aspects of using mice, keyboards and other input devices may increase your risk of discomfort or injury. Optimize your comfort and safety by positioning these devices properly.

Your Work Posture

Sitting in one position for long periods can be uncomfortable. To minimize the potential risk for physical discomfort or injury, it's important that you maintain a proper posture.

- *Head* - When viewing your monitor, your head should not be tilted more than 15 degrees forward, and do not turn your head toward either side.
- *Back* - While sitting at your work surface, make sure your back is supported by the chair's backrest in an erect position or angled slightly backwards.
- *Arms* - Make sure your arms and elbows are relaxed and loose, with your upper arms perpendicular to the floor or tilted downward not more than 15 degrees. Keep your forearms and hands approximately parallel with the floor with elbows bent between 70 and 115 degrees. Keep your elbows close to your sides (less than 20 degrees away from your body).
- *Hands, Wrists, Forearms* - Try to keep your hands wrists and forearms in a relaxed neutral position when using your mouse keyboard or other input devices. For example, while using your keyboard and mouse, rest your forearms (flat) on your desktop.
- *Legs* - Your thighs should be horizontal or angled slightly downward. Your lower legs should be near a right angle to your thighs. Make sure there is sufficient room under the work surface for your legs.
- *Feet* - If after adjusting your chair you cannot rest your feet comfortably on the floor, use a footrest, preferably one that can be adjusted in height and angle.

Overall

- Look away from the screen from time-to-time to help reduce eyestrain. Focus on distant objects briefly, and blink periodically to lubricate your eyes. You also should have your eyes checked on a regular basis and ensure your eyeglass prescription is suitable for working on a computer monitor.

Comfort and Safety Checklist

- Remember to occasionally shift position and move your body. Keeping your body in one position for long periods is unnatural and stressful. When prolonged work is required, take frequent short breaks. As a rule of thumb, a five or ten minute break every hour is a good idea. Short frequent breaks are more beneficial than longer less frequent breaks. Data show that people who work for long periods of time without a break may be more prone to ergonomic injury.
- Changing tasks frequently will help prevent muscle stiffness. Examples: alternating between keyboarding, reading, writing, filing, and moving around in your work environment, helps you maintain a relaxed posture. Occasionally stretch the muscles in your hands, arms, shoulders, neck and back. You should stretch at least as often as you take brief task breaks—at least once every hour.
- Discomfort may be alleviated by using alternative ergonomic designs and accessories such as ergonomically personalized chairs, palm rests, keyboard trays, alternative input devices, prescription eyeglasses, anti-glare screens, and more. Seek additional information from the sources available to you, including your employer, doctor, local office supply store, and the *Information Sources* listed in the online version of *Working in Comfort*, preloaded on the hard disk of your HP computing equipment or available on the HP web site: www.hp.com/ergo.

Getting Started with Your HP Brio

This chapter describes how to begin working with your HP Brio PC and how to use the online HP Brio Center preinstalled on your PC.

Starting Your HP Brio	page 10
Setting Up Windows.....	page 10
Stopping Your HP Brio	page 11
Your PC's Desktop.....	page 12
HP Brio Center-Your Desktop Assistant	page 13
Using Your Software	page 16
Finding Information on the Web	page 16
Securing Your HP Brio	page 16

Starting Your HP Brio

To start the PC for the first time, press the On/Off button.

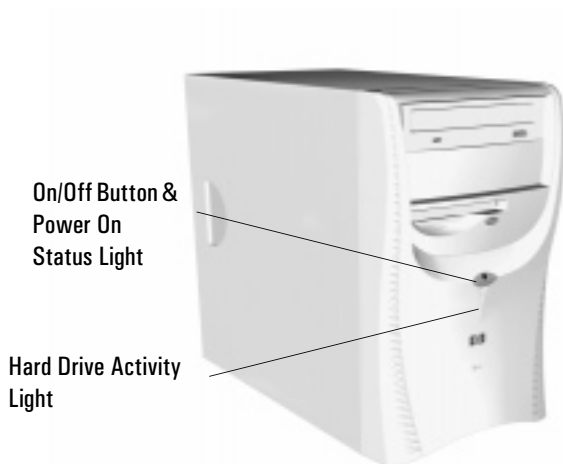

Setting Up Windows

Do not switch off the PC while the software is being initialized as this could cause unexpected results.

- 1 Turn on the monitor first, and then the PC (see “Starting Your HP Brio” above). The light on the front panel comes on.
- 2 The software initialization routine starts. During this time, you will be asked to carry out various tasks such as selecting the regional settings to be used on your PC.
- 3 After the initialization routine has finished, click on **OK** and the HP Brio will restart.

Waking Your HP Brio from a Sleep State

After a period of inactivity, your HP Brio can go into one of a series of sleep states. These are indicated by blinking of the power-on status light on the HP Brio's front panel. To wake the PC, try hitting a key on your keyboard or, if this does not work, press the On/Off button. The PC can only be woken in this way when it is in the deepest sleep state.

Stopping Your HP Brio

To stop the PC, exit all applications and then use your operating system's **Shut Down** command in the **Start** menu (for Windows 98, Windows 2000 and Windows NT 4.0).

Note If you want to force your PC to shut down, for example, if your operating system does not respond, press and hold the power button for approximately 5 seconds.

Your PC's Desktop

My Computer

Use this to see which files and folders are accessible on your PC or network



Desktop

Use this to place shortcuts to programs you use regularly or even files or folders. This is where program windows are displayed.



Recycle bin

The recycle bin stores files temporarily before they are deleted



Start button

Use this to start programs, open documents, find help and change your PC's settings



Taskbar button

This shows you which applications are running. Click on these buttons to open a program window

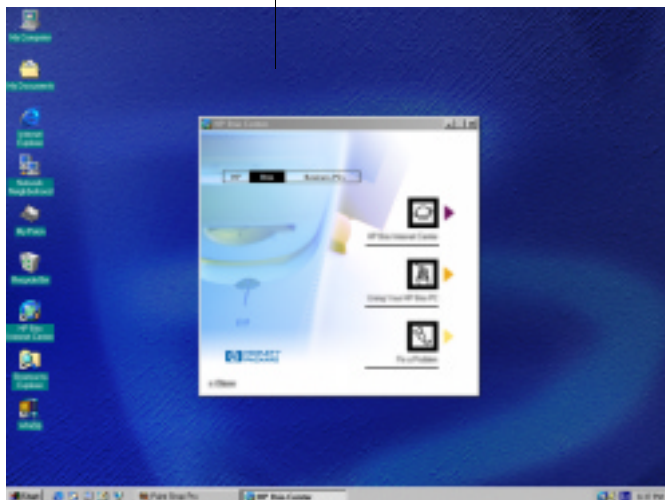

Note

All the features described in this section are standard to Windows. For further details on any of these features, together with details on general Windows functionality, refer to the relevant Windows documentation or to Windows Help.

You can find out more about your Windows desktop by following the Windows Tour (click on **Using Your HP Brio PC - Windows Tour** in the HP Brio Center) or by referring to the Windows documentation supplied with your computer.

HP Brio Center-Your Desktop Assistant



The HP Brio Center helps you get the most out of your PC, acting as a first point of reference for any questions you might have.

You can access the HP Brio Center by:

- double-clicking on the HP Brio Center shortcut  on your PC's Desktop, or
- selecting **HP Brio Center** in the **Start** menu.

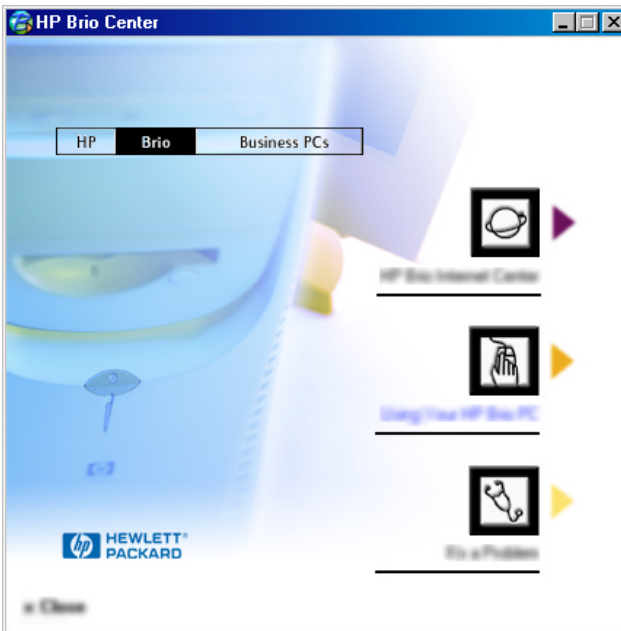

Access Internet-based services

Learn how to use your PC

Learn how to fix problems with your HP Brio PC

Using Your HP Brio PC



You can access **Using Your HP Brio PC** by:

- clicking on  from within the HP Brio Center.

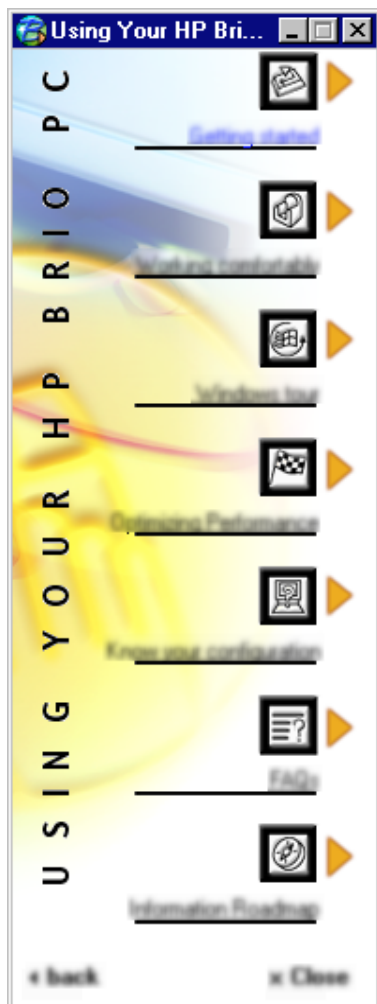

Getting Started

Get tips on using your mouse, keyboard, modem and DVD drive (if available)

Working Comfortably

Get tips on how to set up your PC to maximise comfort and productivity

Windows Tour

Learn how to make the most of your PC's operating system

Optimizing Performance

Tips on getting the best performance out of your PC

Know Your Configuration

Provides information on your hardware configuration

Frequently Asked Questions

Provides answers to frequently asked questions

Information Roadmap

Where to find information on your HP Brio PC

Fix a Problem



You can access **Fix a Problem** by:

- clicking on  from within the HP Brio Center.



Try this first

A useful checklist to run through if you have a problem with your PC. Try this before any other troubleshooting.

Troubleshoot your PC

Tips on solving problems with your PC. Covers topics such as problems with Windows, your DVD drive and modem.

Diagnose your Hardware

Information on how to use e-DiagTools to check your PC's hardware for problems

Get the Latest Updates

Access the HP Brio support Web site for the latest updates to preloaded software and drivers

Using Your Software

When a program is installed on your PC, you can launch it by selecting it from the **Start** menu on your **taskbar**. You can also create a desktop shortcut so that you can launch a program directly from the desktop.

To create a desktop shortcut:

- 1 Open the **Program Files** folder in **Windows Explorer** or **My Computer**.
- 2 Find the file used to launch the program. The file name will end in **.exe**.
- 3 In the **File** menu, select **Create Shortcut**, then click on the newly created file and drag it onto the PC's desktop.

For more details on customizing Windows, refer to Windows online help, accessible from the **Start** menu.

Refer to your program's documentation or online help for information about its use.

Finding Information on the Web

Once you have set up your PC to connect to the Internet, click on **Programs** in the **Start** menu and select your browser. You then simply type in the URL (address) of the Web site you want to visit:

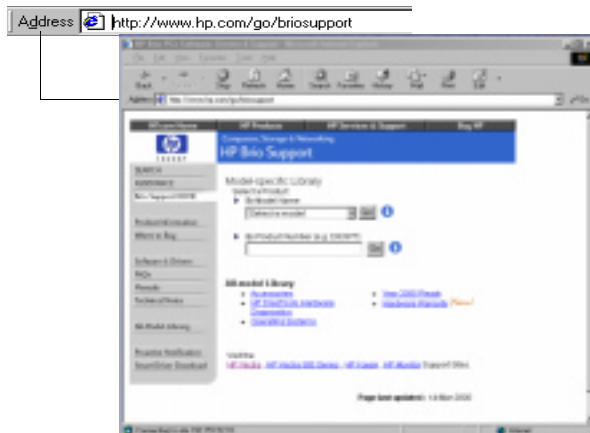

Securing Your HP Brio

You can protect your PC from unauthorized access by using a password. You can also protect your floppy drive, hard drive and CD-ROM drive from unauthorized use. For more information, refer to "HP Setup Program" on page 72.

If You Have a Problem

This chapter describes how to avoid or solve problems with your HP Brio PC.

What to Do First	page 18
My HP Brio Doesn't Start Properly	page 19
My HP Brio Isn't Working Properly.....	page 21
What Kind of Problem Is It?	page 22
Hardware Problems	page 23
Software Problems.....	page 31
My HP Brio Has an Audio (Sound) Problem.....	page 33
My HP Brio Detects an Error at Startup.....	page 35
Frequently Asked Questions.....	page 41
Need More Help?	page 41
HP Hardware Diagnostics (e-DiagTools)	page 42
HP Brio Assist CD-ROM	page 43
Support and Information Services	page 45

What to Do First

Don't panic! Most things that go wrong with computers can be fixed relatively easily — provided you do not rush into them. Use the following checklist to see where you can find help.

- | | | |
|--|---|---|
| <input type="checkbox"/> Is there really a problem with my PC or do I just not know how to do something? | ⇒ | Either <ul style="list-style-type: none">• Refer to chapter 2 in this manual, "Getting Started with Your HP Brio" for basic advice on using your PC. |
| | ⇒ | Or <ul style="list-style-type: none">• Refer to your online HP Brio Center - Using Your HP Brio PC for information on using your mouse, keyboard, DVD drive, CD-RW or modem. |
| <input type="checkbox"/> I still haven't solved my problem and need to do some troubleshooting. Does it seem to be a basic problem with Windows, or with your modem, DVD or CD-RW drive? | ⇒ | Yes <ul style="list-style-type: none">• Refer to your online HP Brio Center - Fix a Problem for information on troubleshooting your PC, your DVD drive, CD-RW or modem. |
| | ⇒ | No <ul style="list-style-type: none">• For more detailed help, refer to the troubleshooting sections starting on page 19. |
| <input type="checkbox"/> Still Need Help? | ⇒ | <ul style="list-style-type: none">• Collect information on your PC (see page 45) then contact your authorized support provider. For Customer Care Center numbers, refer to page 98.• For a wide range of information and support, refer to the HP Brio Web at: www.hp.com/go/briosupport.• For information on your warranty, go to "Regulatory, Warranty and Support", starting on page 79. |

My HP Brio Doesn't Start Properly

The HP Brio Doesn't Power On

Have you checked that...

- The HP Brio's power cord is correctly connected
- You did not hear a series of beeps when you turned the PC on
- The HP Brio's power outlet is working
- The HP Brio's voltage switch is correctly set
- The HP Brio's power-on LED lights when you press the On/Off switch



How

Connect the power cord to a grounded power outlet and to the PC

If you hear a series of beeps when you turn the PC on, refer to page 35

Plug another device into the power outlet and check that it works

- 1 Disconnect the power cord.
- 2 Select the correct setting on the voltage switch located beside the power connector in the rear of the PC.
- 3 Reconnect the power cord.
- 4 Start the PC.

If the LED does not light, check that the status panel connector is connected correctly to the system board. (see page 57).

Advanced Troubleshooting

Have you checked that...

- The problem is not being caused by an internal device
- The power supply is working properly



How

- 1 Disconnect the PC's power cord.
- 2 Remove the PC's main cover and lift out the power supply (see page 51).
- 3 Remove internal connectors from any accessory devices you have added and disconnect any add-on expansion cards.
- 4 Reconnect the devices one by one, booting the PC each time to see if it works correctly.
- 5 If you are still unable to localize the fault, contact your authorized support provider.

- 1 When you power on the PC, check that the light on the On/Off button comes on and that you hear the power supply fan.
- 2 If nothing happens, contact your authorized support provider. The original power supply unit may have to be replaced.

If the problem persists, contact your authorized support provider

The PC Hangs and Emits Beeps During Startup

These beeps indicate errors in the very early stages of the boot sequence (refer to page 35)

<i>Have you checked that ...</i>	<i>How</i>
<input type="checkbox"/> Your memory modules are of the correct type	⇒ <ol style="list-style-type: none">1 Disconnect the PC's power cord.2 Remove the PC's main cover and lift out the power supply (see page 51).3 Replace the memory module with a known working memory module (see page 65).4 Reconnect the PC's power cord and start up the PC.
<input type="checkbox"/> The expansion card you have installed is compatible	⇒ <ol style="list-style-type: none">1 Disconnect the PC's power cord.2 Remove the PC's main cover (see page 49).3 Remove the expansion card (see page 66).4 Reconnect the PC's power cord and start up the PC.
<input type="checkbox"/> That you have not made any changes to the PC's <i>Setup</i> program that may be causing the problem	⇒ <ol style="list-style-type: none">1 Enter the <i>Setup</i> program by pressing F2 when prompted during startup. Refer to page 72.2 Reload the default <i>Setup</i> values by pressing F9.3 Press F10 to exit <i>Setup</i> saving changes.

If the problem persists, contact your authorized support provider

You Get a "non-system disk" or "operating system not found" Message

<i>Have you checked that ...</i>	<i>How</i>
<input type="checkbox"/> You didn't leave a non-bootable floppy disk in your floppy drive when you started the PC	⇒ <ol style="list-style-type: none">1 Check for a non-bootable floppy disk in the floppy drive.2 Remove the floppy disk if there is one in the drive.3 Restart the PC.
<input type="checkbox"/> The device boot order is correct in the <i>Setup</i> program	⇒ <ol style="list-style-type: none">1 Enter the <i>Setup</i> program by pressing F2 when prompted during startup. Refer to page 72.2 Reload the default <i>Setup</i> values by pressing F9.3 Press F10 to exit <i>Setup</i> saving changes.

The Power-On Self Test Detects an Error

An on-screen error message or more than one beep when the HP Brio starts up means that there is a configuration problem with your PC. Refer to page 35 for more information on beep codes.

<i>Have you checked...</i>	<i>How</i>
<input type="checkbox"/> The part of your configuration with which the Power-On Self Test has detected an error	⇒ For more specific troubleshooting information, refer to "My HP Brio Detects an Error at Startup" on page 35
<input type="checkbox"/> If you still have a problem	⇒ Run HP e-DiagTools (refer to page 42)

My HP Brio Isn't Working Properly

The PC is Stuck in Sleep Mode

Have you checked that...

- The PC is really stuck



How

- 1 Move the mouse and press any key on the keyboard. Wait a minute to see if the PC wakes.
- 2 If the power LED is blinking and the PC is not making any noise, the PC is in a deep sleep state for power saving. Press the power button briefly and wait for a minute to see if the PC wakes up.
- 3 If the PC still does not respond, press the power button for 5 seconds. The PC will shut down and any unsaved data will be lost.
- 4 Unplug the power cord from your PC, wait for a few seconds and then plug it in again. Your PC will restart automatically.

The PC Freezes All of a Sudden

Have you checked that...

- One of your applications has not crashed



How

- 1 Try pressing the **CTRL + ALT + DEL** keys simultaneously. A window appears showing the applications currently running. One of these may be marked as **not responding**.
- 2 Select the application and click on **End Task**.
- 3 Restart the program to see if it is working normally.
- 4 If it does not work normally, restart the PC and try again.

- There is a hardware problem



- 1 Run e-DiagTools (refer to page 42).
- 2 If the problem persists, try removing any added memory or expansion cards.

- You have installed enough memory in your PC. It is recommended that you install at least 64MB of RAM to run Windows 2000 or NT 4.0 on your PC. Installing less than this may cause problems running applications.



- 1 Restart your PC.
- 2 Display the PC's Summary Screen by pressing **Esc** during startup. The amount of RAM (main memory) will be displayed. Refer to page 65 for information on adding or replacing memory modules.

- The processor in your PC has not overheated (processors with heatsink fans only)



- 1 Disconnect the PC's power cord.
- 2 Remove the PC's main cover (refer to page 49) and power supply (refer to page 51).
- 3 Make sure the heatsink fan connector is properly connected (refer to page 58).
- 4 Restart your PC and check whether the PC displays an error with the heatsink fan when it boots.

I Can't Shut Down My PC

Have you checked that...

- The PC did not hang when you tried to shut it down 

How

- If you can't shut down and restart the PC normally, press in the power button for 5 seconds. The PC will shut down. Note that any unsaved data will be lost.

My PC Has Become Slow

Have you checked that...

- You are not running too many applications at the same time 

How

- 1 Close any unused applications and check whether the PC's performance improves.

- You have not filled your hard drive with too much data 

- 1 Click on the letter corresponding to your PC's hard drive in **Windows Explorer**. The amount of free space on the disk is displayed at the bottom of the Explorer window.
- 2 Remove or back up any unwanted files.
- 3 Compress any files you do not often have to access with a file compression utility.

- You are not storing large numbers of unnecessary temporary files on your PC 

- Select **Programs** ⇒ **Accessories** ⇒ **System Tools** ⇒ **Disk Cleanup** from the **Start** menu. This will check your system for files you can safely delete.

For more information on optimizing PC performance, refer to the PC's online HP Brio Center

What Kind of Problem Is It?

Is My Problem Hardware or Software Related?

Have you checked that...

- Your PC's hardware is functioning normally. 

How

- Run HP e-DiagTools. Refer to page 42.

Hardware Problems









This section provides information on how to solve problems with your keyboard, monitor, drives or modem.

WARNING

Be sure to disconnect the power cord and any telecommunication cables from your computer before you remove the cover to check the cable connections or jumper settings.

To avoid electrical shock and harm to your eyes by laser light, do not open the laser module of the CD-ROM. The laser module should only be serviced by service personnel. Do not attempt to make any adjustment to the laser unit. Refer to the label on the CD-ROM for power requirements and wavelength. This PC is a class 1 laser product.

The Keyboard Doesn't Work Properly

<i>Have you checked that...</i>		<i>How</i>
<input type="checkbox"/> The keyboard cable is correctly connected		Plug the cable into the correct connector on the back of the HP Brio. Color coding is used for easy matching.
<input type="checkbox"/> The keyboard is clean and no keys are stuck down		Check all keys are at the same height, and none are stuck
<input type="checkbox"/> The keyboard itself is not defective		Either replace the keyboard by a known working unit or try the keyboard with another HP Brio
<input type="checkbox"/> The keyboard settings are not causing a problem		Select Settings ⇒ Control Panel ⇒ Keyboard from the Start menu to view your keyboard settings
<input type="checkbox"/> You are using the correct driver. This driver is provided with all Windows NT 4.0, Windows 98 and Windows 2000 preloaded systems. For other operating systems, refer to your operating system's documentation.		Download the latest driver from HP's Web at: www.hp.com/go/briosupport
<input type="checkbox"/> You are using the latest BIOS for your PC		Download the latest BIOS and instructions for its installation from HP's Web at: www.hp.com/go/briosupport
<input type="checkbox"/> You didn't spill anything on the keyboard		Clean the keyboard with a damp cloth. Do not wet it.

The Monitor Doesn't Work Properly

The HP Brio's power indicator light works but the monitor remains blank

Have you checked that...

The monitor is switched ON (LED is on)



How

Refer to the monitor manual for an explanation of the LED signals (green, orange, or blinking)

The monitor's power cord is correctly connected



Connect the power cord – ensure it is plugged into a working grounded power outlet and into the monitor

The monitor (video) cable is correctly connected



Connect the monitor (video) cable – ensure it is properly connected to both the HP Brio and the monitor

The monitor's brightness and contrast settings are correctly set



Check the settings using the monitor's OSD (on-screen display) or using controls on the front of the monitor

There is an image during boot but then the screen goes blank

Have you checked that...

The monitor settings in your HP Brio are compatible with your monitor



How

- Windows 98 & Windows 2000: Restart the HP Brio. The HP Brio opening screen is displayed.

For Windows 98, when you hear a beep, press **F8** and then start the HP Brio in safe mode.

For Windows 2000, when prompted, press **F8** and then start the HP Brio in VGA mode. When the PC has started, double-click on the **Display** icon in your PC's **Control Panel**, then click on the **Settings** button. Use the sliding control to reset the resolution.

- Windows NT: Restart the HP Brio and enter VGA mode when prompted during start-up.

For other operating systems, refer to your operating system's documentation.

The picture breaks up, rolls, shudders or blinks

Have you checked that...

The monitor is correctly connected or set up



How

- Check the video cable connections to the PC
- Check that there is not interference from a fluorescent light or fan





All your hardware is working properly



Run HP e-DiagTools (refer to page 42)

There's a Problem with the Hard Disk

Have you checked that...

- You have not received a S.M.A.R.T. alert from the HP Brio Management Agent indicating that your hard disk drive is defective 
- The disk is not damaged in some way 
- You have not disabled the option to boot your PC from the hard drive in the **Boot** menu of the *Setup* program 
- The hard disk drive has been detected 
- The hard disk drive is properly configured in the *Setup* program 

How

Such alerts can appear on your screen at startup or while the PC is running. If you receive such an alert, carry out an immediate data backup, then contact HP support at www.hp.com/go/briosupport to ask for a replacement hard drive.

Run ScanDisk and Disk Defragmenter to see if they detect a problem with the hard disk drive. To access these utilities, select **Programs** ⇒ **Accessories** ⇒ **System Tools** from the **Start** menu.



Enter the *Setup* program by pressing **F2** at startup, then check the configuration of the **Boot** menu.

Enter the *Setup* program by pressing **F2** at startup, then go to the **Advanced** menu. You should see a hard disk drive declared in the **IDE Devices** submenu.

Enter the *Setup* program by pressing **F2** at startup. Make sure you have enabled the **On-chip Primary IDE** and the **On-chip Secondary IDE** fields under **Hardware Protection** in the **Boot** menu.

Advanced Troubleshooting

Have you checked that...

- All the hard drive's internal connections and both ends of the status panel are correctly connected 
- The jumpers on the hard drive are set correctly 

How

Check that the drive's power and data cables are correctly connected at both ends (hard drive and system board). Refer to page 60 for connections to the hard drive and page 57 for connections to the system board.





Check that the jumpers on the hard drive are in CS (cable select) mode

There's a Problem with the Floppy Drive

Have you checked that...

- You are using a formatted diskette and it is inserted correctly
- The floppy is clean
- The *Setup* program is correctly configured for your floppy drive
- The hardware is working properly

How

-  You will receive an on-screen error if the diskette is not properly formatted
-  Use a diskette cleaning kit (see your PC dealer)
-  Enter the *Setup* program by pressing **F2** at startup, then:
 - Go to the **Advanced** menu. You should see a hard disk drive declared in the **Flexible Disk Drive** submenu.
-  Run e-DiagTools to see if it detects a problem with the floppy drive (refer to page 42)

Advanced Troubleshooting

Have you checked that...

- The drive's power and data cables are correctly connected

How

-  Check that the drive's power and data cables are correctly connected at both ends (floppy drive and system board). Refer to page 59 for connections to the floppy drive and page 57 for connections to the system board.

There's a Problem with the CD-ROM, CD-RW or DVD Drive

Have you checked that...

There is a disc inserted in the drive



How

- Click on the drive letter assigned to your drive in Windows Explorer. If you receive a message such as **D:\ is not accessible/device is not ready**, this means there is no disc in the drive.
- Open the drive and check whether there is a disc inside.

The *Setup* program is correctly configured for your drive



Enter the *Setup* program by pressing **F2** at startup, then:

- Make sure you have enabled the **On-chip Primary IDE** and the **On-chip Secondary IDE** fields under **Hardware Protection** in the **Boot** menu.
- Go to the **Advanced** menu. You should see a CD-ROM, CD-RW or DVD-ROM drive declared in the **IDE Devices** submenu.

The device boot order is set correctly in the *Setup* program



- Enter the *Setup* program by pressing **F2** at startup, then go to the **Boot** menu. If you intend to boot from the CD-ROM drive, you should place **CD-ROM** before **HDD** in the **Boot** ⇒ **Boot Device Priority** submenu.

The hardware is working properly



Run e-DiagTools to see if it detects a problem with the drive (refer to page 42).

Advanced Troubleshooting

Have you checked that...

All cables (data, power and audio) have been properly connected both to the drive and to the system board.



How

Check that the drive's power and data cables are correctly connected at both ends (drive and system board). Refer to page 62 for connections to the drive and page 57 for connections to the system board.

The jumpers on the drive are set correctly



Check that the jumpers on the hard drive are in CS (cable select) mode

For more information on using and troubleshooting your DVD drive, refer to the PC's online HP Brio Center

The DVD Drive Doesn't Play DVD Video

Have you checked that...

- The DVD disc you are trying to play and your DVD drive have the same regional code setting. Your DVD drive's regional code setting is set by the first DVD disc you insert in the drive. After several uses the regional drive becomes fixed and cannot subsequently be changed.
- You have either a hardware or a software MPEG decoder installed on your system
- Your PC's hardware and software configuration supports the playing of DVDs. The following configuration is recommended:
 - At least an Intel Celeron processor with a minimum clock speed of 400 MHz.
 - 64MB of memory (Windows 2000, Windows 98)
 - Display settings of 800 x 600 pixels, High Color (16-bit).
- You are using the latest drivers. These can be downloaded from the HP Brio support Web site at: www.hp.com/go/briosupport.
- You are not trying to play DVD video under Windows NT 4.0. DVD video is not supported by this operating system.
- You have enabled DMA mode on the Secondary IDE channel in the *Setup* program, accessed by pressing F2 during startup.

For more information on using and troubleshooting DVD, refer to the PC's online HP Brio Center

The CD-ROM, CD-RW or DVD Drive Doesn't Open

What to Do...

- 1 If you have difficulty removing a disc from the drive (during a power failure for example), you can use the manual eject button.

With a thin, solid rod, such as the end of a paper clip, push the drive's manual eject button

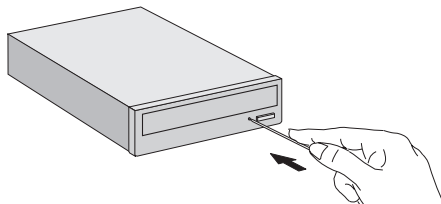

- 2 The drive door will be released, opening slightly. Carefully pull it open fully and retrieve the disc.
- 3 To close the drive door, push it gently closed without forcing it. The drive door may not close completely until it is fully functional (for example, when the power comes back on).

The Printer Doesn't Work

The Printer Will Not Print

Have you checked that...

- The printer is on
- There is paper in the printer
- You didn't plug in the printer's parallel data cable (where applicable) when the PC was already on
- The correct printer driver is installed
- The printer is configured correctly
- The parallel port is configured correctly in the PC's *Setup* program

How

- ⇒ • Check the power and data cables are correctly connected and press the printer's power button.
- ⇒ • Check the printer's paper tray
- ⇒ 1 Shut the PC down, then restart it.
2 Try to print again.
- ⇒ • Check that the correct printer driver is installed on your PC by clicking on the **Start** menu, then selecting **Settings** ⇒ **Printers**. Your printer's driver should be displayed in the Printers window.
- ⇒ • Click on the **Start** menu, then select **Settings** ⇒ **Printers**. Right-click on the icon for the printer you want to use and ensure that **Set as default** is selected and that the printer is set to work online.
- If the printer is on your network, you can set it up by browsing for it in **Network Neighborhood**, clicking on the printer's icon, then clicking on **Install** in the **File** menu.
- Print out a test page to test the printer
- ⇒ 1 Switch the PC OFF then ON.
2 When the message **Press F2 to Enter Setup** appears, press the **F2** key. Check that **Integrated I/O Ports** ⇒ **Parallel Port** is not disabled in the **Advanced** menu.
3 This setting should be **Auto**.

The Printer Prints Garbled Information

Have you checked that...

- The correct printer driver is installed
- The printer's data cables are connected properly

How

- ⇒ • Check that the correct driver is installed on your PC by clicking on the **Start** menu, then selecting **Settings** ⇒ **Printers**. The driver for your printer should be displayed in the Printers window that appears.
- ⇒ • Check the cables and, if it still does not work, check the product documentation

A Newly Installed Device Is Not Recognized

Have you checked that...

The device is installed or connected properly



If it is an external device, that it is switched on



How

- Expansion cards:
Check that expansion cards are properly seated in their slots
- Internal devices:
Check any internal cables for bent pins and poor connection
- External devices:
Check any connections to external devices for bent pins or poor connection
- Press the device's power button if there is one, and check that the power cable is correctly connected

The Modem Doesn't Work

Have you checked that...

Your PC has the correct modem country setting



The problem is not described in the **Fix a Problem** section of the HP Brio Center on your PC



How

Refer to "Setting the Country for Your Modem" on page 5

Select **HP Brio Center** in your PC's **Start** menu

Software Problems

The Power Light Is On But My Software Won't Run

Have you checked that...

There is no information about what is going on in the accompanying documentation



The software has been correctly installed



How

Refer to the application software documentation and/or the operating system documentation for guidance

- 1 Check for any error messages when you try to run the software.
- 2 Remove and then reinstall the software.
- 3 If the problem continues, contact the software manufacturer's support services.

The Date and Time are Wrong

Have you checked that...

The battery has not become discharged. This may happen when the PC has been unplugged for too long.



How

Change the date and time, by selecting **Settings** ⇨ **Control Panel** ⇨ **Date/Time** from the **Start** menu or use the *Setup* program (see page 72). If necessary, install a new battery (see page 69).

You Get the Message "Some necessary system files are corrupted"

Have you checked that...

You didn't delete any system files



How

Reinstall the operating system or return the PC to its factory configuration by using the *HP Brio Assist CD-ROM (System Recovery)*. Refer to page 43 for more information.

Forgotten Your PC's BIOS Password

You have forgotten the password that has been set in the *Setup* program to prevent unauthorized users from starting your PC



- 1 Ask your system administrator, if you have one, to remind you of the password.
- 2 If you cannot find out the password, clear passwords (see page 74). This will allow the PC to start without a password.

Problems Using the Euro Symbol

Have you checked that...

- Your operating system and applications support this feature



How

- Only the latest operating systems such as Windows 98 and Windows 2000, provide integrated support for the Euro symbol (in certain languages only).
- Only certain versions of Windows NT 4.0 provide support for the Euro symbol.

For more information on how to enable support of the Euro symbol, refer to Microsoft's Web site at: www.microsoft.com/windows/euro.asp.

- The font you are using supports the Euro symbol



If the symbol is supported by a particular font, you will see it in the Character Map, accessible by selecting **Programs ⇒ Accessories ⇒ System Tools ⇒ Character Map**.

- Your keyboard has a Euro symbol. If not, you can configure the keyboard.



Select **Settings ⇒ Control Panel** in the Windows **Start** menu, then double-click on **Keyboard** and select the **Language** or **Input Locales** tab in the **Keyboard Properties** Window. Click on **Add** and select the country that corresponds to your keyboard, and click **OK** to exit the Control Panel.

My HP Brio Has an Audio (Sound) Problem

No Sound When Running Applications

Have you checked that...

- The volume, mute, and balance settings are correct



How

- Right-click on the speaker icon on the taskbar, then select **Open Volume Control** and adjust the settings if required
- Refer to the operating system documentation for more information

Advanced Troubleshooting

Have you checked that...

- The problem is not caused by a hardware conflict. Hardware conflicts occur when two or more peripheral devices compete for the same signal lines or channels. Conflicts between your audio interface and a peripheral device might be due to the settings of the I/O addresses, IRQ or DMA channel.



How

Check the settings of the audio interface and other accessories in your system.

No Sound When Playing a Multimedia or Audio CD

Have you checked that...

- The volume control on the CD-ROM drive is correctly set



How

Turn up the volume dial on the front of the drive

- If you are using headphones or speakers:
- they are correctly connected
 - the operating system volume controls are correctly set.



- Refer to page 4 for information on connecting speakers and headphones
- Double-click on the speaker icon on the taskbar, then set the required volume with the volume slider

- The audio cable for the CD-ROM drive is correctly connected to the connector on the system board.



Refer to page 57

A New Add-On Sound Card Does Not Work

Have you checked that...

- You have disabled the integrated sound features on your PC as required



How

To disable integrated sound, enter **F2** during startup then check that **Integrated Audio Interface** is disabled in the **Advanced** menu.

There Is a Humming Noise

Have you checked that...

- The power grounding of your audio components is adequate



How

Plug all devices into adjacent power outlets (outlets within 5 cm / 2 inches of each other), or use line filters

The PC Hangs While Recording

Have you checked that...

- You are not filling up your hard disk with uncompressed digital audio. For example, one minute of stereo sound recorded at a resolution of 44 kHz will occupy about 10.5 MB.



How

- Before recording, check that there is enough free space on your hard disk.
- Data compression can reduce the space required. The A-law and m-law hardware compression used by the audio interface enables the sampling of sound at a resolution of 16-bits, but it generates the same quantity of data as an 8-bit sample.

No Output From 8 or 16 Bit Digitized Sounds

Have you checked that...

- You do not have an interrupt conflict or that you have not selected the wrong DMA channel



How

Use your operating system's audio control software to change the audio interface's DMA channel or IRQ setting

Audio Input From Microphone Too Low

Have you checked that...

- The microphone specifications meet the requirements of the 16-bit sound components. The microphone should be a 600-ohm electret type.



How

Check the documentation that came with your microphone

My HP Brio Detects an Error at Startup

When your PC starts up, it tests your hardware configuration for any problems. Your PC may emit a series of distinct loud beeps if a problem is found during the very early stages of startup.

The BIOS in your PC then performs a Power-on SelfTest (POST). If a problem is detected during POST, an error is displayed on your monitor.

If you hear a series of beeps, you should count them as this will help you detect the cause of the problem. Here are some examples:

- 1 = absent or incorrectly connected processor
- 2 = power supply in protected mode
- 3 = memory failure detection
- 4 = video card failure

If you miss the beep code, turn off the PC, then press and hold in the On/Off button for a few seconds and listen for the signal again.

This section describes what to do if your PC encounters a startup error.

Memory Test Error

Note: this error is indicated by a series of beeps while the screen remains blank

Have you checked that...

- The PC's memory modules are installed correctly



How

- 1 Disconnect the power cord.
- 2 Remove the PC's main cover (refer to page 49) and power supply (refer to page 51).
- 3 Check the memory modules are correctly installed, of the correct type and in the correct sockets (refer to page 65).
- 4 Close the PC, reconnect the power cord and check that the PC boots (starts).

- The PC's memory modules are working



- 1 Disconnect the power cord.
- 2 Remove the PC's main cover (refer to page 49) and power supply (refer to page 51).
- 3 Replace the memory modules by known working memory modules from the same model of PC (refer to page 65).
- 4 Close the PC, reconnect the power cord and check that the PC boots (starts).

Advanced Troubleshooting

Have you checked that...

- You are using the latest BIOS for your PC



How

Download the latest BIOS and instructions for its installation from HP's Web at:
www.hp.com/go/briosupport

If the problem persists, contact your authorized support provider

Keyboard Test Error

Have you checked that...

The keyboard cable is correctly connected 

The keyboard is clean and keys are not stuck down 

The keyboard is working 

The keyboard port is working 

You are using the latest BIOS for your PC 

How

- 1 Switch off the PC.
- 2 Plug the cables into the correct connectors on the back of the PC (you may have problems if you connect the mouse to the keyboard connector).

Check all keys are at the same height, and none are stuck (keyboard)

- 1 Switch off the PC.
- 2 Replace the keyboard by a known working unit.
- 3 Switch on the PC, and check it works.

 Run e-DiagTools. Refer to page 42.

- 1 Disconnect the keyboard from the PC.
- 2 Attach the keyboard to another PC of the same model.
- 3 If the keyboard works you may need a new system board. Contact your authorized support provider.

Download the latest BIOS and instructions for its installation from HP's Web at:
www.hp.com/go/briosupport

If the problem persists, contact your authorized support provider

Floppy Drive Test Error

Have you checked that...

- The drive is correctly configured in the PC's *Setup* program. Refer to page 45.



How

- 1 Switch the PC OFF then ON.
- 2 When the message **Press F2 to Enter Setup** appears, press the **F2** key. Refer to page 72.
- 3 Check the floppy disk drive is enabled and that the correct type is selected (refer to page 26).

- The floppy drive is working



Insert a known working floppy disk and see if it works



Run e-DiagTools. Refer to page 42.

- You are using the latest BIOS for your PC



Download the latest BIOS and instructions for its installation from HP's Web at:
www.hp.com/go/briosupport

Advanced Troubleshooting

Have you checked that...

- The drive cables are correctly connected



- 1 Disconnect the power cord.
- 2 Remove the PC's main cover (refer to page 49) and power supply (refer to page 51).
- 3 Check the floppy drive's power and data cables are correctly connected (refer to page 57 and page 59).
- 4 Close the PC then switch it on and check it works.

- The drive cable is working



- 1 Disconnect the power cord.
- 2 Remove the PC's main cover (refer to page 49).
- 3 Replace the floppy drive cable by a known working cable from the same model of PC, if possible.
- 4 Close the PC then switch it on and check it works.

- The drive itself has not failed



- 1 Disconnect the power cord.
- 2 Remove the PC's main cover (refer to page 49).
- 3 Replace the floppy drive by a known working drive from the same model of PC, if possible. Refer to page 59.
- 4 Close the PC then switch it on and check it works.
- 5 If the drive works, replace the defective drive.

Refer to page 26 for more information on troubleshooting floppy drives. If the problem persists, contact your authorized support provider

Hard Disk, DVD or CD-ROM Drive Test Error

Have you checked that...

- You have not received a S.M.A.R.T. alert from the HP Brio Management Agent indicating that your hard disk drive is defective
- The drive is correctly configured in the PC's Setup program
- The hard disk, DVD or CD-ROM drive is working
- You are using the latest BIOS for your PC



How

Important: Carry out an immediate data backup, then contact your local Customer Care Center (refer to page 98)

- 1 Switch the PC OFF then ON.
- 2 When the message **Press F2 to Enter Setup** appears, press the **F2** key.
- 3 Check the drive is enabled and the correct type is selected.

Run e-DiagTools from the *HP Brio Assist CD-ROM (Drivers & Utilities)* to test your hard drive. To test your DVD or CD-ROM drive, run e-DiagTools from the Utility Partition on your hard drive. Refer to page 42.

Download the latest BIOS and instructions for its installation from HP's Web at:
www.hp.com/go/briosupport

Advanced Troubleshooting

Have you checked that...

- The drive cables are correctly connected
- The drive cable is working
- The drive itself has not failed



How

- 1 Disconnect the power cord.
- 2 Remove the PC's main cover (refer to page 49).
- 3 Check the drive's power and data cables are correctly connected (refer to page 57 and page 60).
- 4 Close the PC then switch it on and check it works.

- 1 Disconnect the power cord.
- 2 Remove the PC's main cover (refer to page 49).
- 3 Replace the drive cable by a known working cable from the same model of PC, if possible.
- 4 Close the PC then switch it on and check it works.

- 1 Disconnect the power cord.
- 2 Remove the PC's main cover (refer to page 49).
- 3 Replace the drive by a known working drive from the same model of PC, if possible. Refer to chapter 4.
- 4 Close the PC then switch it on and check it works.

Refer to the section starting on page 23 for more information on troubleshooting drives. There is also more DVD troubleshooting information in the online HP Brio Center, under "Fix a Problem". If the problem persists, contact your authorized support provider

CMOS Test Error

Have you checked that...

The internal battery is working



How

- 1 Set the PC to the correct time (refer to the operating system manual).
- 2 Switch off and unplug the PC for an hour.
- 3 Restart the PC and check the time is correct.
- 4 If the time is incorrect, replace the PC's battery by a new one (refer to page 69).

You are using the latest BIOS for your PC



Download the latest BIOS and instructions for its installation from HP's Web at:

www.hp.com/go/briosupport

The CMOS is not corrupted



- Clear your PC's CMOS in the PC's *Setup* program (the recommended method) if you have access to this option. Refer to page 74.
- Clear your PC's CMOS manually. Refer to page 74.

Advanced Troubleshooting

Have you checked that...

Power is correctly connected to the system board



How

- 1 Disconnect the power cord.
- 2 Remove the PC's main cover (refer to page 49) and power supply (refer to page 51).
- 3 Check the power connector is correctly attached to the system board.
- 4 Close the PC, reconnect the power cord and check that the PC boots (starts).

You don't need to restore the default configuration settings







- 1 Switch the PC OFF then ON.
- 2 When the message **Press F2 to Enter Setup** appears, press the **F2** key.
- 3 Press **F9** to restore default values.
- 4 Press **F10** to exit the *Setup* program saving changes.

If the problem persists, contact your authorized support provider

Serial or Parallel Port Test Error

Have you checked that...

- The port is correctly configured in the PC's *Setup* program 
- You have not connected a device incorrectly or forgotten to switch it on 
- You have installed the correct device drivers 
- There is not a hardware problem 
- You are using the latest BIOS for your PC 

How



- 1 Switch the PC OFF then ON.
 - 2 When the message **Press F2 to Enter Setup** appears, press the **F2** key. Refer to page 72.
 - 3 Check the port is enabled and the correct setting is selected under **I/O Device Configuration** in the **Advanced** menu.
- 1 Switch off the PC.
- 2 Plug the cables into the correct connectors on the back of the PC.
- 3 Switch on the PC and the external devices.
- Refer to the documentation for your serial or parallel device.
- Run e-DiagTools. Refer to page 42.
- Download the latest BIOS and instructions for its installation from HP's Web at:
www.hp.com/go/briosupport

If the problem persists, contact your authorized support provider

Other Configuration Problems

If the POST produces an error not covered in this section...

Have you checked that...

- The *Setup* program settings are correct 
- You are using the latest BIOS for your PC 

How

- 1 Turn on or restart the PC.
 - 2 When the message **Press F2 to Enter Setup** appears, press the **F2** key. Refer to page 72 for more information.
- Download the latest BIOS and instructions for its installation from HP's Web at:
www.hp.com/go/briosupport

Frequently Asked Questions

FAQs

- | | | | |
|--------------------------|---|---|---|
| <input type="checkbox"/> | How can I reinstall my PC's operating system? | ⇒ | Use the <i>HP Brio Assist CD-ROM (System Recovery)</i> provided with your PC |
| <input type="checkbox"/> | Why is my PC running slowly/producing strange messages? | ⇒ | <ul style="list-style-type: none"> • If you are connected to a network, the slowness of your PC may be caused by the network. • Your PC may be infected by a virus. Use an antivirus utility to erase any viruses. <p>Or, update your PC's BIOS. You can download the BIOS and updating instructions from www.hp.com/go/briosupport.</p> |
| <input type="checkbox"/> | I've been experiencing problems with my PC ever since I installed some new software. What can I do? | ⇒ | Uninstall the software to see whether this solves the problem. If the problem continues, contact the software manufacturer for help or information on known compatibility problems. |
| <input type="checkbox"/> | Can I use USB hardware devices with the operating system preloaded on my PC? | ⇒ | Yes. USB is supported by both Windows 98 and Windows 2000. |
| <input type="checkbox"/> | How can I find out what hardware and BIOS version are used in my PC? | ⇒ | Restart the PC and press ESC during the Power-On-Self-Test (POST). The BIOS version will be displayed at the top of the screen. |
| <input type="checkbox"/> | Where can I get information about the latest HP drivers? | ⇒ | From HP's web site:
www.hp.com/go/briosupport |

There is a lot more troubleshooting information, including FAQs on your PC's online HP Brio Center

Need More Help?

For more detailed help refer to the troubleshooting information which is available on HP's support web site at:

www.hp.com/go/briosupport

HP Hardware Diagnostics (e-DiagTools)

Note HP strongly recommends you use e-DiagTools. It provides the most effective way of solving most hardware problems. It can also help you distinguish between a hardware and a software problem.

What Is e-DiagTools For?

With e-DiagTools, you can:

- check the configuration of your PC and see whether it is functioning correctly
- diagnose hardware-related problems
- provide precise information to support personnel so that they can solve your problems quickly and efficiently.

How Do I Run e-DiagTools?

You can run e-DiagTools from:

- The Utility Partition on your PC's hard drive.
To run diagnostics from the hard drive, restart the PC and press **F10** when the message **Press F10 to start hardware diagnostics...or any other key to proceed** appears on screen.
- Your PC's *HP Brio Assist CD-ROM - Drivers & Utilities*. Refer to "HP Brio Assist CD-ROM" below.

HP Brio Assist CD-ROM

Your PC comes with two *HP Brio Assist CD-ROMs* (Windows 98 version) or three (Windows 2000 version):

- *HP Brio Assist CD-ROM - System Recovery* (1 or 2 CDs)
- *HP Brio Assist CD-ROM - Drivers & Utilities* (1 CD)

HP Brio Assist CD-ROM - System Recovery

Use this CD-ROM to:

- perform a full system recovery
- replace Windows 2000 with Windows NT 4.0 (feature available in some countries only)

HP Brio Assist CD-ROM - Drivers & Utilities

Use this CD-ROM to:

- reinstall individual device drivers or utilities
- run e-DiagTools hardware diagnostics.

Using the HP Brio Assist CD-ROMs

To use the HP Brio Assist CD-ROMs, you must either:

- boot the PC from the CD-ROM
- browse the CD-ROM while the PC is running.

Note If the PC does not boot from the *HP Brio Assist CD-ROM - System Recovery*, you must change the order of devices from which your PC tries to start up. To do so, restart your PC and press **F2** when prompted to enter the HP *Setup* program. Change the **Boot Device Priority** in the *Setup* program **Boot** menu so that **ATAPI CD-ROM Drive** appears before **Hard Drive** (refer to "Support and Information Services" on page 45).

Performing a Full System Recovery or Alternative OS Installation

You can use the *HP Brio Assist CD-ROM - System Recovery* to recover the PC's factory supplied configuration by restoring the operating system (OS), drivers and HP supplied applications. This will return the PC's software configuration to a state similar to when the PC was originally shipped.

In some countries on Windows 2000 models, you can also replace the preloaded Windows 2000 operating system with Windows NT 4.0.

Note Restoring the original factory configuration or downgrading will completely erase the main hard drive partition. It is highly recommended to (a) back up all your data before proceeding, (b) remove all devices you have added, (c) update your PC's BIOS (refer to page 76) and (d) have driver software to hand for any add-on hardware. The whole process normally takes about half an hour.

If you intend to replace your Windows 2000 operating system with Windows NT 4.0, you should check that you will still be able to use your system as intended. For example, Windows NT 4.0 does not support Power Management or USB. If you need to use a USB device, then you should not perform this operation.

- 1 Insert the *HP Brio Assist CD-ROM - System Recovery* in your CD-ROM drive and restart your PC.
- 2 From the main menu, select the operating system you want to install.
- 3 Follow the onscreen instructions.
When the copy operation is complete a message will appear. Remove the CD-ROM and restart the PC.
- 4 Reinstall drivers for any devices that were not part of your PC's original configuration. All data files and software applications that were not part of your PC's original configuration PC must also be restored.

Manually Reinstalling Drivers

- 1 Insert the *HP Brio Assist CD-ROM - Drivers & Utilities* in the CD-ROM drive while your operating system is running.
- 2 Using Windows Explorer, select the driver(s) you need to reinstall.
- 3 Follow the installation instructions contained in the **README** file accompanying the driver.

Running HP e-DiagTools

- 1 Insert the *HP Brio Assist CD-ROM - Drivers & Utilities* in the CD-ROM drive and restart the PC.
- 2 In the menu that appears, select **Run Hardware Diagnostics**.
- 3 Follow the onscreen instructions in the e-DiagTools screen that appears.

Support and Information Services

You can learn more about HP service and support from the support Web site: www.hp.com/go/briosupport.

Information on Your Warranty and Customer Care Centers

Details about the warranty that comes with your HP Brio PC and how to contact HP Customer Care Centers are available on page 86 and page 98 respectively.

Collecting Information on Your PC Before Contacting HP Support

Take a piece of paper and note down some of the information mentioned below. This will help HP support deal with your problem quickly and efficiently:

PC Description	
Model number	See label on the right side of your PC.
Serial number	See label on the right side of your PC.
RAM <ul style="list-style-type: none"> Number of megabytes installed 	<ul style="list-style-type: none"> The amount of RAM is displayed on the Summary Screen, accessed by pressing Esc during start-up or in the <i>Setup</i> program, accessed by pressing F2 during start-up.
Question or Problem	
Write down a brief description of the problem	
Frequency	How often has the problem occurred?
Run OK?	How long has the PC been running normally?
Recent changes to the PC	Have there been any recent changes made to the PC?
Any e-DiagTools errors?	Run e-DiagTools. Refer to page 42.
Hardware	
Which BIOS version is used?	The BIOS version is displayed on the Summary Screen, accessed by pressing Esc during start-up or in the <i>Setup</i> program, accessed by pressing F2 during start-up.
Any BIOS parameter changes?	Did the problem occur after changes were made to the BIOS using the Setup program?
Operating System	
Are you using the original operating system software that came preloaded on your PC?	What is the operating system version?
If no, what is the operating system version?	Select Settings ⇄ Control Panel from the Start menu, then click on the System icon. The operating system version is displayed under System .
Any operating system-generated error messages	Please note down exact text of error message.
Any errors during boot (Power-On Self Test). This test checks all installed components.	Any POST errors will be displayed on your monitor screen or signalled by beep codes. If you hear any beep codes, you should count them.

Upgrading and Replacing HP Brio Hardware

This chapter describes how to:

- upgrade hardware components
- replace faulty components

Important - Before You Start	page 48
Inside the Computer.....	page 48
Accessing Internal Components	page 49
Replacing the System Board	page 55
Cables and Connectors in Your PC	page 57
Replacing a Processor.....	page 58
Replacing the Floppy Drive.....	page 59
Replacing the Hard Drive	page 60
Installing an Expansion Bay Drive.....	page 62
Installing a Memory Module.....	page 65
Installing an Expansion Card	page 66
Replacing the Power Supply Unit.....	page 67
Replacing the Battery	page 69

If you want to find out about available accessories for your PC, refer to the HP accessories Web site at: www.hp.com/go/pccessories

Important - Before You Start

Read this section before installing any components in your PC.

WARNING For your safety, never remove the PC's cover without first removing the power cord from the power outlet, and any connection to a telecommunications network. Always replace the cover before switching the PC on again.

Caution Static electricity can damage electronic components. Turn all equipment OFF. Don't let your clothes touch the accessory. To equalize the static electricity, rest the accessory bag on top of the PC while you are removing the accessory from the bag. Handle the accessory as little as possible and with care.

Inside the Computer

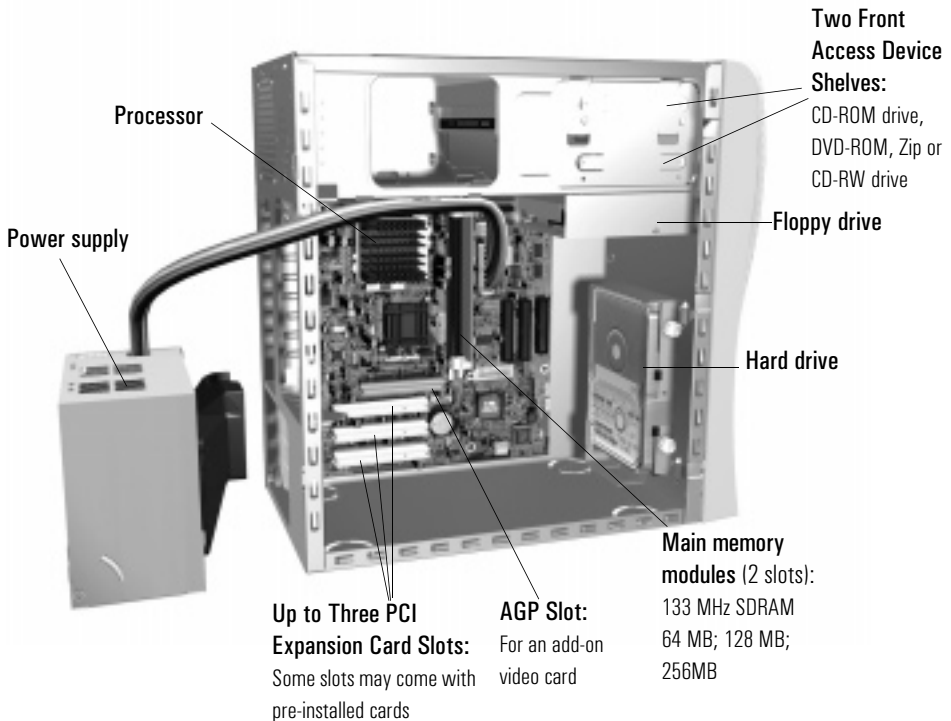

Accessing Internal Components

Removing and Replacing the Main Cover

WARNING For your safety, disconnect the power cord and all external cables.

To Remove the Main Cover

- 1 Place the PC on a flat surface and stand behind it.
- 2 Disconnect all cables from the rear of the PC.
- 3 Loosen the two thumb screws at the rear of the PC.
- 4 Slide the cover back by about 2 cm (0.6 inches).
- 5 Tip the cover to the side and lift it off.



To Replace the Main Cover

- 1 Position the metal flap on the bottom inside of the cover over the guide rail of the PC, leaving a gap of about 2 cm (0.6 inches) between the cover and the front of the PC.
- 2 Tilt the cover towards the PC.

Accessing Internal Components

- 3 Check that the bottom inside of the cover fits correctly over the guide rail, then slide the cover towards the front of the PC.



- 4 Tighten the two screws on the back of the main cover.

Removing and Replacing the Power Supply Unit

To Remove the Power Supply

Note It is recommended that for many operations on the inside of the PC, you remove the power supply unit without disconnecting the power cables to allow easy access to internal components. Where this is necessary, it is indicated as such in the following pages. If you need to replace your existing power supply with a new one, refer also to page 67.

- 1 Once you have removed the main cover, lay the PC on its side.
- 2 Release the power supply cables from the cable clamp under the floppy drive bay.
- 3 Press down the retaining clip at the top of the power supply unit, and holding the unit carefully, rotate it upwards.
- 4 Push the second retaining clip outwards and lift the power supply unit out of the PC and lay it by the underside of the PC, not beside the front panel. If you are not replacing the power supply, you do not need to remove its connections to internal devices or the system board.

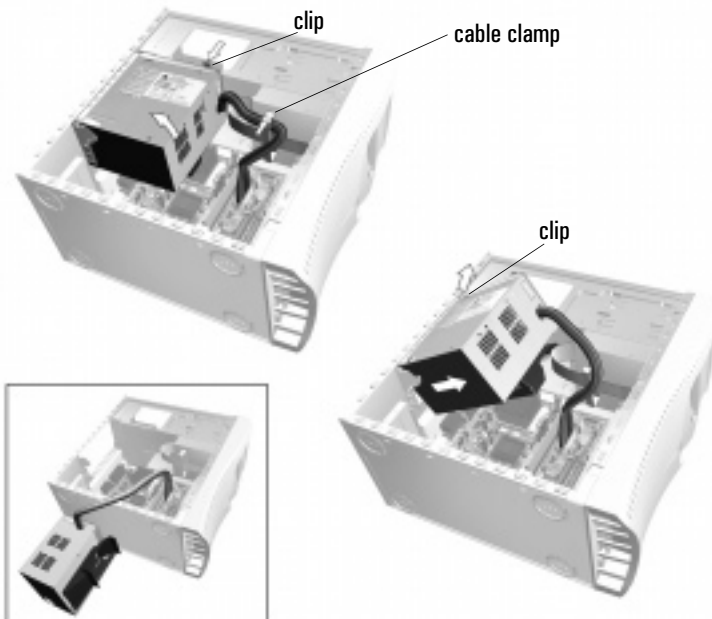

To Replace the Power Supply

Caution Ensure that you do not trap or crush any internal cables when replacing the power supply.

- 1** Insert the protruding pins at the back of the unit in the guiding grooves.
- 2** Rotate the power supply back into place, making sure that you are not trapping or crushing any cables on the underside of the unit (especially if your power supply has an airflow guide fitted).
- 3** Snap the unit back into place.

Removing and Replacing the Side Panel

To Remove the Side Panel

You are only required to remove the side panel of the PC when removing or replacing 5.25 inch devices (such as CD-ROM, CD-RW, DVD-ROM or Zip drives) in the upper expansion shelves.

- 1 Once the main cover has been removed, loosen the screw on the side panel.
- 2 Slide the side panel back by about 2 cm (0.6 inches).
- 3 Lift the side panel up and off the PC.

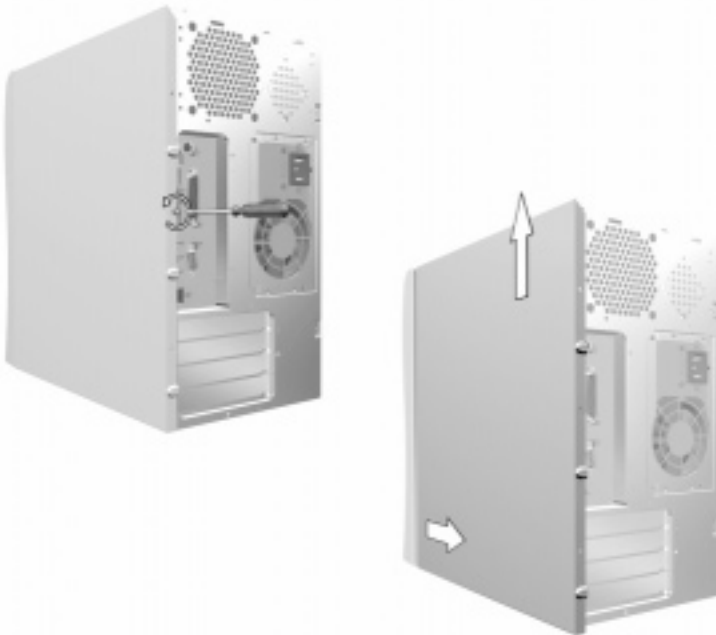

To Replace the Side Panel

- 1 Lower the side panel onto the PC, making sure that the inside of the panel fits correctly into the guide rail. Leave a gap of about 2 cm (0.6 inches) between the panel and the front of the PC.
- 2 When you are sure that the inside of the panel fits correctly into the guide rail, slide the panel towards the front of the PC.
- 3 Tighten the screw that holds the panel in place.

Removing and Replacing the Front Panel

To Remove the Front Panel

Note You must first remove the main cover before removing the front panel.

- 1 Standing in front of the PC, pull open the three plastic clips to the left side of the panel until the panel begins to come off.
- 2 Tilt the panel round slightly and carefully lift it off.

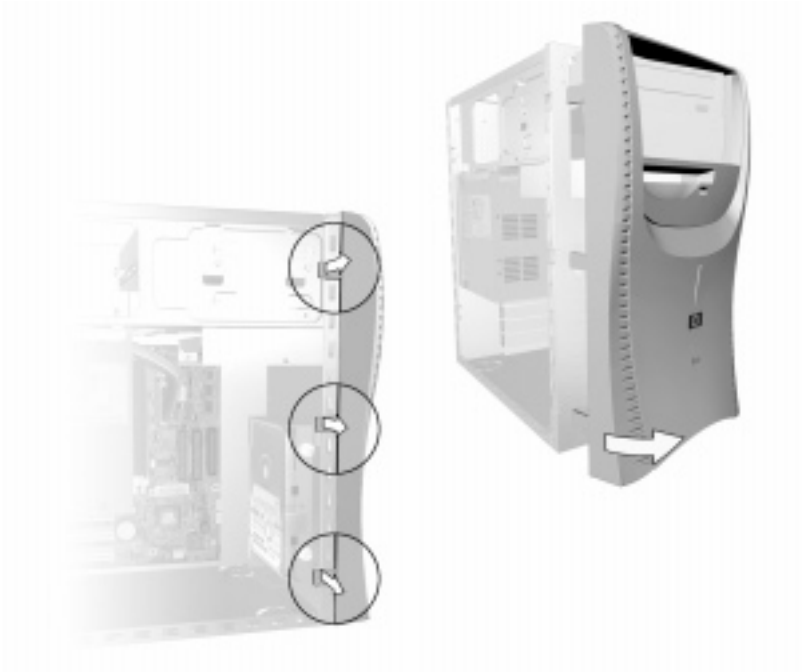

- 3 Lay the front panel on a flat surface beside the PC.

To Replace the Front Panel

- 1 Standing in front of the PC, engage the 3 plastic positioning tabs in the holes to the right of the front panel.
- 2 Tilt the panel round so that it snaps into place on the other side.

Replacing the System Board

- 1 Switch off the PC and remove the PC's main cover (refer to page 49).
- 2 Lay the PC on its side.
- 3 Remove the power supply unit to gain better access to the inside of the PC (refer to page 51).
- 4 Remove all cables and expansion cards from the system board.
- 5 Remove the seven screws shown below.



- 6 Lift the system board up slightly, then pull it carefully away from the rear panel and lift it out of the PC.
- 7 Remove any components you want to reuse such as the processor or memory modules. Refer to the appropriate section for instructions on removing the individual components.
- 8 Install any components removed from the old system board in the new board. Refer to the appropriate section if you require instructions on installing the individual components.
- 9 Replace the system board in the PC, ensuring that the rear connectors on the system board are correctly engaged in the corresponding holes at the rear of the PC.

Replacing the System Board

- 10** Attach the seven screws.
- 11** Reconnect the following connectors and cables: status panel connector, floppy drive cable, CD-ROM cable, hard drive cable, processor fan cable (if appropriate), power cables and CD audio cable, if you have a CD-ROM, CD-RW or DVD drive. The power and floppy cables should be held in place by the cable clamp under the floppy drive. If you can't remember how to reconnect them, refer to page 57.
- 12** Replace the power supply unit. Refer to page 52.
- 13** Replace the PC's main cover. Refer to page 49.

Cables and Connectors in Your PC

Internal devices such as the power supply, processor, hard drives, DVD and CD-ROM drives use the following data and power cables. These are connected to the system board and internal devices as shown below. You must also connect the power connector, status panel connector and CD audio connector (if a CD-ROM is fitted) to the system board.

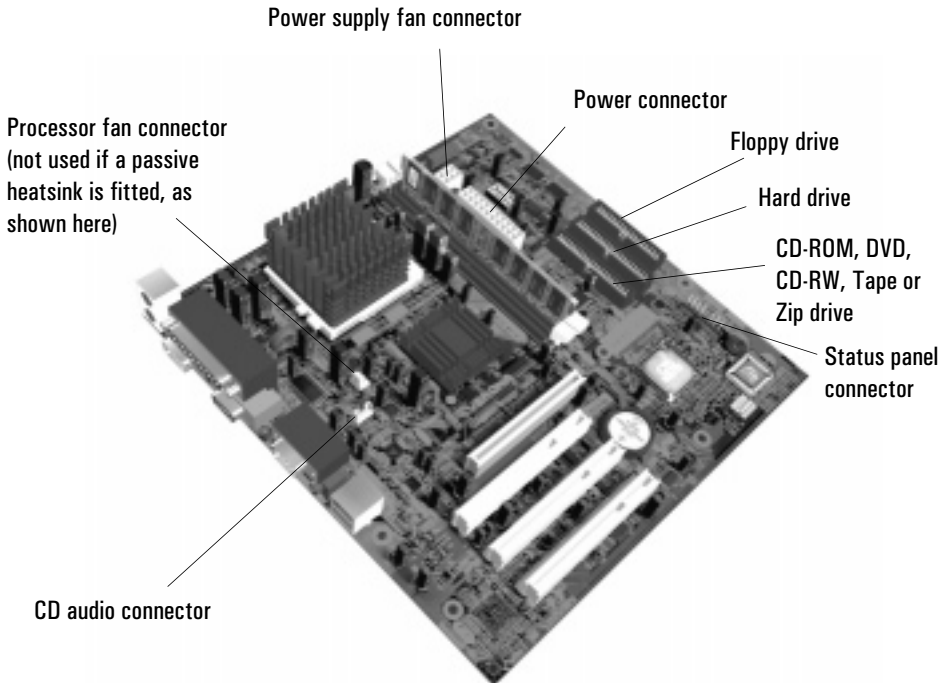

Replacing a Processor

WARNING For your safety, disconnect the power cord and all external cables.

- 1 Switch off the PC and remove the PC's main cover. Refer to page 49.
- 2 Lay the PC on its side.
- 3 Remove the power supply unit to gain better access to the inside of the PC (refer to page 51).
- 4 If the processor has an active heatsink (a heatsink with a fan), disconnect the processor fan cable from the system board.
- 5 Unclip and remove the heatsink or heatsink/fan unit. This requires you to release it first on one side then on another.
- 6 Raise the lever to the side of the socket to release the old processor, then lift it out.

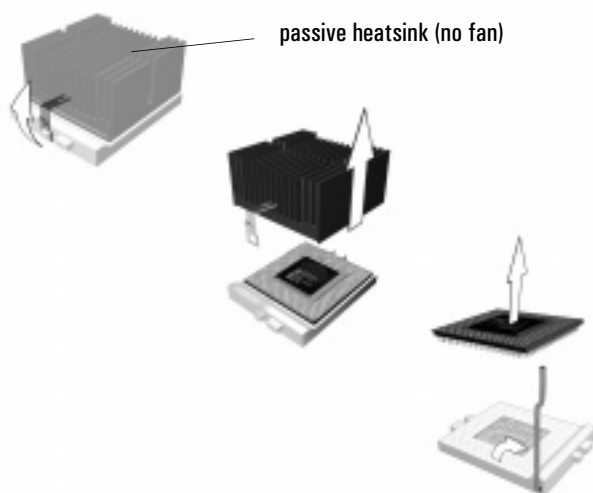

- 7 Install the new processor in the socket, with its corner markers facing the corner markers on the socket, then lower the lever to lock it in place.
- 8 Fit the new heatsink or heatsink/fan unit and fasten its retention clip first on one side then on the other. The heatsink can only go on one way. If it is not positioned symmetrically over the processor, remove it and fit it the other way round.
- 9 Reconnect the processor fan cable, if one is fitted. Refer to page 57.
- 10 Replace the PC's cover. Refer to page 54.

Replacing the Floppy Drive

- 1 Switch off the PC and remove the PC's main cover. Refer to page 49.
- 2 Remove the PC's front panel. Refer to page 54.
- 3 Remove the floppy drive's two connectors.

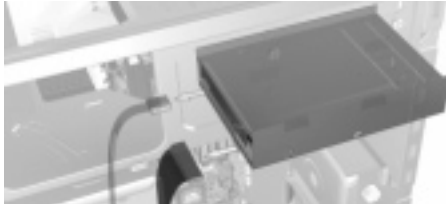

- 4 Remove the floppy drive fixing screw.
- 5 Pull firmly on the floppy drive tray to release it from its retaining clip, and slide the tray out through the PC's front panel.



- 6 Slide the new drive into the floppy drive bay until it clicks in place.
- 7 Replace the screw.
- 8 Replace the floppy drive connectors.
- 9 Replace the front panel. Refer to page 54.
- 10 Replace the main cover. Refer to page 49.

Note If the PC does not start properly, you may have reconnected the status panel connector wrongly. Remove the front panel and check the connection of the cable.

Replacing the Hard Drive

For information on recovering the contents of your old hard drive, refer to “HP Brio Assist CD-ROM” on page 43.

WARNING For your safety, disconnect the power cord and all external cables.

- 1 Switch off the PC and remove the PC's main cover. Refer to page 49.
- 2 Lay the PC on its side.
- 3 Remove the power supply unit to gain better access to the inside of the PC (refer to page 51).
- 4 Loosen the two thumb screws that hold the hard drive in place.

Caution Take care when handling the hard drive. A small drop can damage it.

- 5 Press firmly downwards on the hard drive and tilt it away from the hard drive tray until it can be lifted out. Hold the drive tray firmly so as not to drop it.

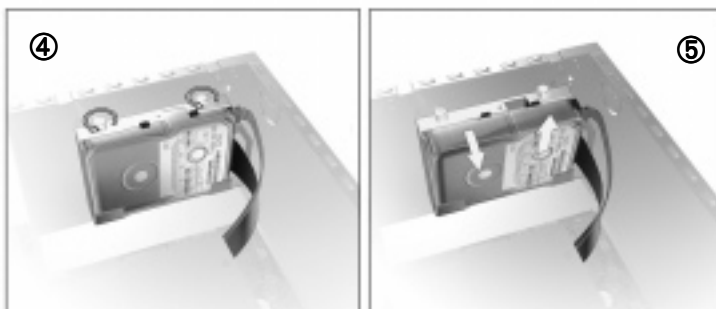

- 6 Remove the hard drive's data and power cables.

- 7** Carefully insert the two metal retention pins in the holes on the underside of the hard drive, and ensure that the middle screw hole is facing the tray's alignment window.
- 8** Push down on the drive then tilt it towards the PC chassis until the middle screw hole appears in the tray's alignment window.
- 9** Tighten the two thumb screws.
- 10** Reconnect the power and data cables. Refer to "Cables and Connectors in Your PC" on page 57 if you are unsure of which cables to use.
- 11** Replace the power supply unit.
- 12** Replace the PC's main cover. Refer to page 54.

Installing an Expansion Bay Drive

Replacing a CD-ROM or DVD Drive in the Top Bay

WARNING To avoid electrical shock and harm to your eyes by laser, do not open the laser module. The laser module should be serviced by service personnel only. Do not attempt to make any adjustment to the laser unit. Refer to the label on the CD-ROM for power requirements and wavelength. This product is a class 1 laser product.

- 1 Switch off the PC and remove the PC's main cover. Refer to page 49.
- 2 Remove the PC's side panel. Refer to page 53.
- 3 Remove the PC's front panel. Refer to page 54.
- 4 Disconnect the cables from the rear of the drive.



- 5 Remove the four retaining screws, then slide the old drive out of the front of the PC.



- 6 Slide the new drive in from the front of the PC.
- 7 Replace the four screws.
- 8 Replace the audio, data and power cables.
- 9 Check that the jumpers on the drive are set to CS (cable select) mode.
- 10 Replace the front panel. Refer to page 54.
- 11 Replace the side panel.
- 12 Replace the main cover. Refer to page 49.

Installing a Drive in the Lower Expansion Bay

- 1 Switch off the PC and remove the PC's main cover. Refer to page 49.
- 2 Remove the PC's side panel. Refer to page 53.
- 3 Remove the PC's front panel. Refer to page 54.
- 4 Remove the plastic masking plate from the front panel by prising the retaining tabs open by hand.

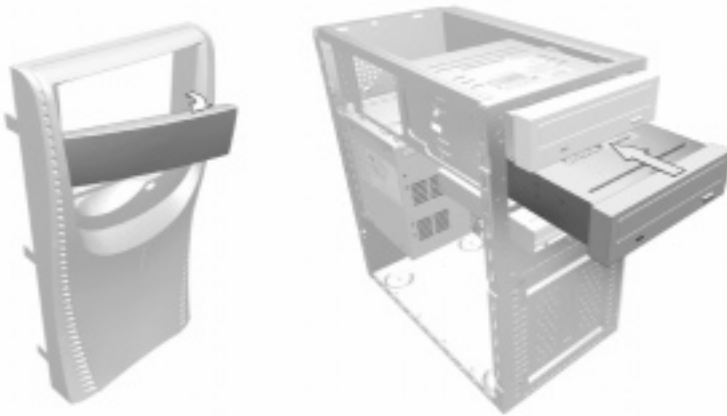

- 5 If the bay has a metal blanking plate, pull it out by hand.
- 6 Slide the drive in from the front of the PC.

Installing an Expansion Bay Drive

- 7 Tighten the four screws that fasten the drive to the bay.

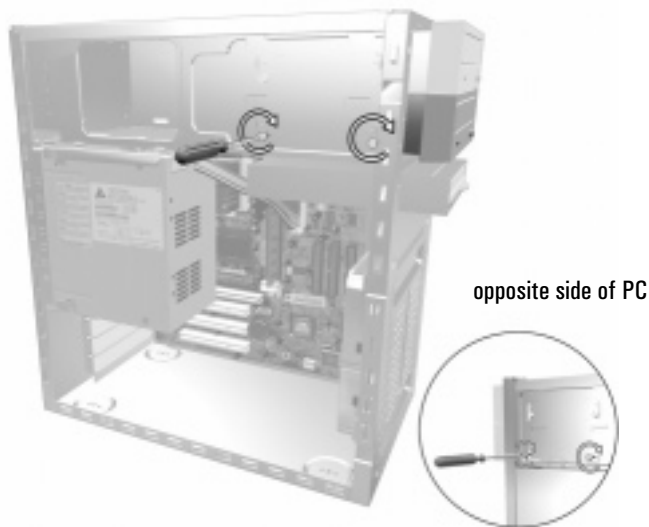

- 8 Connect the data and power cables, and for a DVD, CD-RW or CD-ROM drive, the CD audio cable.
 - If this is the second device installed in the expansion bays, fit the data connector marked **CD SLAVE**.
 - If this is the only device, fit the end CD connector marked **CD Master**.



- 9 Check that the jumpers on the drive are set to CS (cable select) mode.
- 10 Replace the front panel. Refer to page 54.
- 11 Replace the side panel. Refer to page 53.
- 12 Replace the main cover. Refer to page 49.

Installing a Memory Module

- 1 Switch off the PC.
- 2 Remove the PC's main cover. Refer to page 49.
- 3 Lay the PC on its side so you can more easily reach in to access the system board.
- 4 Remove the power supply unit to gain better access to the inside of the PC (refer to page 51).

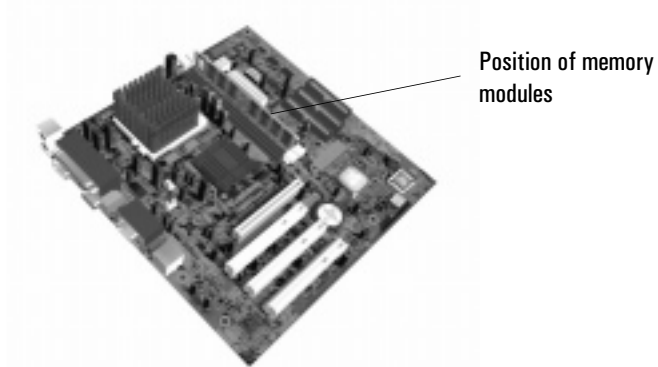

- 5 Either remove the module you want to replace or locate an empty memory module socket.
- 6 Make sure that the socket's clips are open.
- 7 Align the grooves on the bottom of the module with the corresponding marks on the socket and push it firmly into place. The clips close automatically.

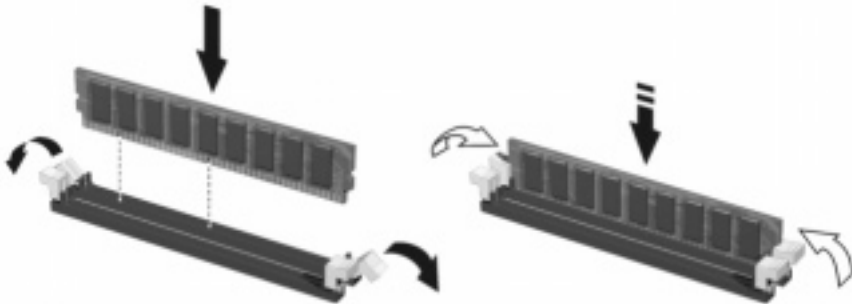

- 8 Replace the power supply unit.
- 9 Replace the main cover. Refer to page 54.

Installing an Expansion Card

- 1 Switch off the PC.
- 2 Remove the PC's main cover. Refer to page 49.
- 3 Lay the PC on its side.
- 4 Press down on the clip on the card retention mechanism until it comes loose and lift it out.
- 5 Locate the slot you want to use.
 - If fitting a card in an empty slot, remove the slot cover.
 - If replacing a card in an expansion slot, disconnect it from the slot and slide it out.
- 6 Aligning the new card carefully, press it firmly into the socket.
- 7 Replace the card retention mechanism by pressing on its flat edge until it clips back into place.

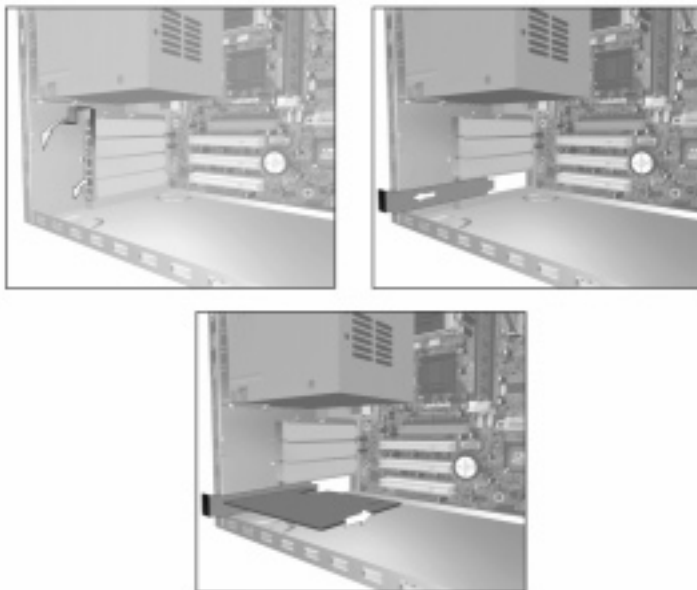

- 8 Replace the PC's main cover. Refer to page 49.

Replacing the Power Supply Unit

WARNING Hewlett-Packard does not support power supply upgrades. This information is provided to help you replace a defective power supply unit. For your safety, only replace with a power supply provided by HP support services.

To avoid electrical shock, do not open the power supply. There are no user-serviceable parts inside.

- 1 Switch off the PC and remove the main cover.
- 2 Lay the PC on its side.
- 3 Release the power supply cables from the cable clamp situated under the floppy drive unit.
- 4 Press down the retaining clip at the top of the power supply unit, and holding the unit carefully, rotate it upwards.
- 5 Push the second retaining clip outwards and lift the power supply unit out of the PC and lay it by the underside of the PC, not beside the front panel.

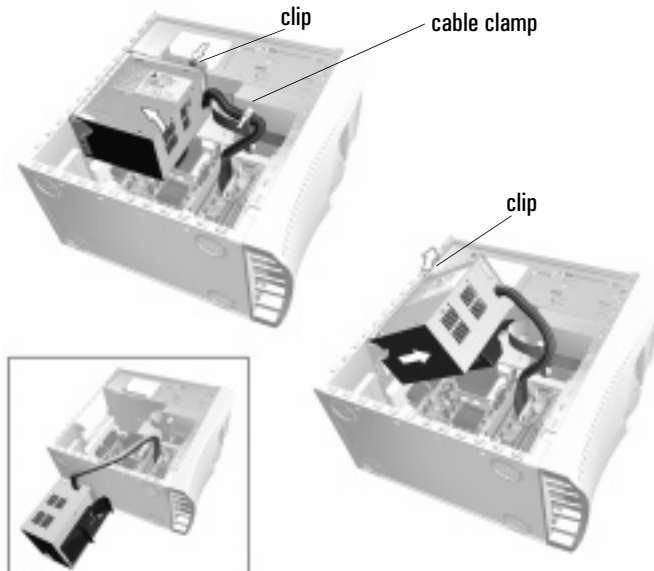

- 6 Disconnect all power cables from installed drives and from the system board.

Replacing the Power Supply Unit

- 7 Remove the 5 screws from the casing of the power supply unit and remove the power supply from its casing.



- 8 Remove the airflow guide (if fitted).



- 9 Place the new power supply unit in its casing, attach the five screws and fit the airflow guide as shown here (if there is one).



- 10 Place the new power supply unit inside the computer, taking care not to snag any cables.
- 11 Reconnect all the power cables to the drives and the system board.
- 12 Secure the cables inside the cable clamp
- 13 Replace the cover. Refer to page 54.
- 14 Check that the voltage switch is set correctly for your country.

Replacing the Battery

WARNING There is a danger of explosion if the battery is incorrectly installed. For your safety, never attempt to recharge, disassemble or burn the old battery. Replace the battery only with the same or equivalent type recommended by the manufacturer. The battery in this PC is a lithium battery which does not contain heavy metals, nevertheless, in order to protect the environment, do not dispose of batteries in household waste. Please return used batteries to the shop from which you bought them, or to the dealer from which you purchased your PC, or to HP, so that they can either be recycled or disposed of in an environmentally sound way. Returned used batteries will be accepted free of charge.

- 1 Switch off the PC and remove the PC's main cover (refer to page 49).
- 2 Lay the PC on its side.
- 3 Remove the power supply unit to gain better access to the inside of the PC (refer to page 51).

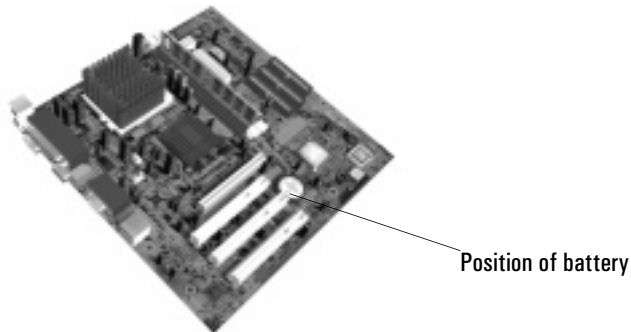

- 4 Remove the old battery by pressing the retaining clip with a flat-headed screwdriver and lifting the battery clear of the battery holder.



- 5 Place the new battery in the battery holder, with the "+" sign on top and ensure that it is properly seated.
- 6 Replace the power supply unit.
- 7 Replace the PC's main cover. Refer to page 54.

Replacing the Battery

— Technical Information

This chapter provides technical information on your PC. For more detailed information, refer to the PC's datasheet in the library on HP's web site: www.hp.com/desktops.

HP Setup Program	page 72
Clearing Your PC's CMOS (BIOS) Settings	page 74
Your PC's BIOS	page 76
Technical Characteristics	page 77

HP Setup Program

The HP *Setup* program allows you to view and change the configuration of your HP Brio PC. Sometimes you may also need to enter the *Setup* program to reconfigure your PC after installing new hardware components. The *Setup* program has online help to guide you through any changes you have to make.

Entering the Setup Program

To enter the *Setup* program, press **F2** when the Hewlett-Packard logo appears on screen.

Setup Program Menus

Your PC's *Setup* program contains a series of menus, which are selected with the right and left arrow keys on your keyboard. You can select an item within a menu with the up and down arrow keys. When an item is selected, Setup displays a description of its function on the right of the screen.

The *Setup* program contains the following menus:

- **Main** - for basic information on your configuration including processor speed, the amount of installed RAM, installed drives, time and date.
- **Advanced** - for setting Advanced Features.
- **Security** - for setting a password to restrict access to your computer. It is possible to set a Supervisor or a User password. The Supervisor can change all settings and the User can only change the date and time. Setting a password will, by preventing access to the *Setup* menus, protect your computer's configuration. You can also disable the floppy, hard drive and CD-ROM drive from within this menu page to prevent unauthorized use.
- **Power** - for selecting power-management modes to reduce the amount of energy used after specified periods of inactivity. If your computer stays idle for a certain amount of time, your system switches from Full Power Mode to Sleep Mode in order to reduce power consumption. In Sleep Mode, graphics, the processor and hard disks are stopped. A user event, such as from the keyboard, can cause the system to resume to Full Power Mode within a few seconds. Other events may also wake up the system: a ring on an external modem, a signal sent by an expansion card (network card etc.).

- **Boot** - for choosing your boot device order and priority. You can select the order of the devices from which the BIOS (Basic Input Output System) attempts to boot the operating system. During the POST (Power On Self-Test), if the BIOS is unsuccessful at booting from one device, it will try the next one on the Boot Device Priority list until an operating system is found. The default boot device is the floppy disk.
- **Exit**: for leaving the *Setup* program.

Setting System Defaults

The *Setup* program changes system behavior by modifying the power-on initialization parameters. Setting incorrect values may cause system boot failure. If this occurs, press the **F9** key while you are in the *Setup* program to load the *Setup* program's default values or select **Load default values** in the **Exit** menu of the *Setup* program. This should enable the computer to boot properly.

Note If a Supervisor password is set, you need to enter the password to set system defaults.

HP strongly recommends you make a note of any changes you make while in the *Setup* program.

Clearing Your PC's CMOS (BIOS) Settings

CMOS is a chip that keeps a record of installed components when your PC is turned off. Clearing CMOS settings may help you resolve some common problems. For example:

- when you need to clear passwords to have full access to your PC's BIOS *Setup* program
- when your PC cannot detect an expansion card or other device
- when you are having problems booting the PC.

You can clear CMOS settings:

- by using your PC's BIOS *Setup* program
- by opening your PC and clearing CMOS manually.

Clearing CMOS Using the Setup Program

If you are able to gain access to your PC's *Setup* program, use the following simple method to clear CMOS settings:

- 1 Restart your PC and press **F2** when the message **Press F2 to enter Setup** appears on screen. Refer to page 72.
- 2 From within the *Setup* program, press **F9** to load *Setup* defaults.
- 3 Press **F10** to exit *Setup* saving changes.

Manually Clearing CMOS and Passwords

You should clear CMOS manually when you cannot gain access to the PC's *Setup* program.

To clear CMOS and Passwords:

- 1 Remove the PC's main cover. Refer to page 49.

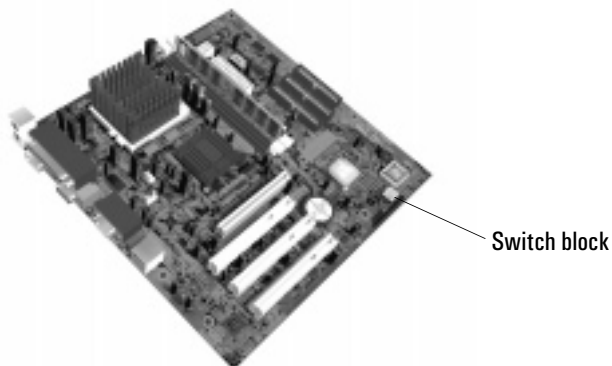

Switch	Switch function:	
1	CMOS	OFF = normal (default) ON = clear CMOS and reload default values in <i>Setup</i>
2	Password	OFF = enabled (default) ON = disabled/clear User and Administrator passwords
3	Reserved	OFF = default
4	Reserved	OFF = default

- 2** Change the position of switch 1 to ON to clear both CMOS and passwords. If you want to clear passwords only, set switch 2 to ON. Note that other BIOS settings will remain unchanged.
- 3** Replace the main cover and reconnect the power cord.
- 4** Switch on the PC and wait for the message “settings have been cleared” to appear.
- 5** Shut down the PC, remove the cover and power cord and set switch 1 to OFF. Set switch 2 to OFF if you have been resetting passwords only.
- 6** Restart the PC and press **F2** to enter the *Setup* program when prompted. You now have full access to the *Setup* program. For more information on *Setup*, refer to page 72.

Your PC's BIOS

The BIOS (Basic Input Output System) in your PC has the following roles:

- It tests and configures your PC's hardware components during the POST (Power On Self-Test).
- It lets you configure your PC by using the *Setup* program. See “HP Setup Program” on page 72.
- It provides the link between the software running on your PC and your PC's hardware.

The BIOS is stored in a chip on the system board. A PC's BIOS is specific to that PC.

Updating Your PC's BIOS

Many problems with your PC can be solved by updating (flashing) the PC's BIOS.

Updating (flashing) your BIOS is a simple procedure that involves booting your PC from a floppy disk containing the new BIOS.

The latest BIOS for your PC along with instructions on updating can be downloaded from HP's Brio Support Web site at:

www.hp.com/go/briosupport.

Technical Characteristics

As an ENERGY STAR partner, HP has determined that this product meets the ENERGY STAR guidelines for energy efficiency (Windows 98 and Windows 2000 only). To check power consumption figures, refer to the following table.

HP Brio BA410 Characteristics	
Weight (configuration with 1 CD-ROM drive, excluding keyboard and display)	9.8 kilograms (21.6 pounds)
Dimensions	38.1 cm (Depth) by 19.0 cm (Width) by 35.8 cm (Height) (14.8 inches by 7.4 inches by 14.0 inches)
Footprint	0.068 m ² (0.73 sq ft)
Acoustic noise emission (ISO 7779)	<i>Sound Power</i>
<ul style="list-style-type: none"> Operating (idle): 	LwA ≤ 3.7 B(A)
Power consumption - Windows 98, Windows 2000	
<ul style="list-style-type: none"> Operating (idle): Sleep: 	<ul style="list-style-type: none"> < 32W < 3W
Storage Humidity	8% – 85%

Note Operating temperature and humidity ranges may vary depending on the mass storage devices installed. High humidity levels can cause improper operation of disk drives. Low humidity ranges can aggravate static electricity problems and cause excessive wear of the disk surface.

The power consumption and acoustics figures given in the tables above are valid for the standard configuration as shipped. For more information, refer to the product's data sheet at HP's web site: www.hp.com/desktops

When the computer is turned off with the power button on the front panel, the power consumption falls below 3W, but it is not zero. The special on/off method used by these computers considerably extends the lifetime of the power supply. To reach zero power consumption in "off" mode, either unplug the power outlet or use a power block with a switch.

Regulatory, Warranty and Support

This chapter describes the warranty and support conditions for your HP Brio PC, and how to contact support.

Note that you should read chapter 3, “If You Have a Problem” before asking for assistance from your authorized support provider.

Regulatory Information	page 80
Recycling your PC	page 85
HP Hardware Warranty.....	page 86
HP Software Limited Warranty.....	page 94
HP Software License Agreement	page 95
International Warranty.....	page 97
HP Year 2000 Warranty	page 97
HP Customer Care Center Phone Numbers.....	page 98
Other Services.....	page 99

Regulatory Information

Declaration of Conformity According to ISO/IEC Guide 22 and EN 45014

Manufacturer's Name: Hewlett-Packard

Manufacturer's Address: 5, avenue Raymond Chanas - Eybens - 38053 Grenoble Cedex 09 - FRANCE

Declares that the product:

Product Name: Personal Computer

Model Number: HP Brio BA410

conforms to the following Product Specifications:

Safety:

International: IEC 60950:1991 + A1 + A2 + A3 + A4 / GB4943-1995

Europe: EN 60950:1992 + A1 + A2 + A3 + A4

Electromagnetic Compatibility:

CISPR 22:1993 + A1 + A2 / EN 55022:1994 + A1 + A2 Class B ¹⁾

EN 50082-1:1992

IEC 801-2:1991 / prEN 55024-2:1992 - 4kV CD, 8kV AD

IEC 801-3:1984 / prEN55024-3:1991 - 3V/m

IEC 801-4:1988 / prEN 55024-4:1993 - 0.5 kV Signal Lines, 1 kV Power Lines

IEC 555-2:1982 + A1:1985 / EN 60555-2:1987

IEC 61000-3-3:1994 / EN 61000-3-3:1995

GB9254-1998

FCC Title 47 CFR, Part 15 Class B ²⁾

ICES-003, Issue 3

VCCI-B

AS/NZ 3548:1995

Supplementary information: The product herewith complies with the requirements of the following Directives and carries the CE-marking accordingly: EMC Directive 89/336/EEC and Low Voltage Directive 73/23/EEC, both amended by the Directive 93/68/EEC.

¹⁾The product was tested in a typical configuration with Hewlett-Packard Personal Computer Systems.

²⁾This Device complies with Part 15 of the FCC Rules. Operation is subject to the following two conditions:

(1) this device may not cause harmful interference, and

(2) this device must accept any interference received, including interference that may cause undesired operation.

Jean-Charles MIARD

Quality Manager

Grenoble, April 2000:

For Compliance Information ONLY, contact:
USA Contact: Hewlett-Packard Company,
Corporate Product Regulations Manager,
3000 Hanover Street, Palo Alto, CA 94304.
Phone: (415) 857-1501()



FCC (for USA only)

Federal Communications Commission Radio Frequency Interference Statement

Warning:

This equipment has been tested and found to comply with the limits for a Class B digital device, pursuant to Part 15 of the FCC Rules. These limits are designed to provide reasonable protection against harmful interference in a residential installation. This equipment generates, uses, and can radiate radio frequency energy and, if not installed and used in accordance with the installation manual, may cause harmful interference to radio communications. However, there is no guarantee that interference will not occur in a particular installation. If this equipment does cause harmful interference to radio or television reception, which can be determined by turning the equipment off and on, the user is encouraged to correct the interference by one or more of the following measures:

- Reorient or relocate the receiving antenna.
- Increase the distance between the equipment and the receiver.
- Connect the equipment to an outlet on a different circuit to the one the receiver is connected to.
- Consult your dealer or an experienced radio/TV technician for help.

Hewlett-Packard's FCC Compliance Tests were conducted using HP-supported peripheral devices and HP shielded cables, such as those you receive with your system. Changes or modifications not expressly approved by Hewlett-Packard could void the user's authority to operate the equipment.

Notice for Canada

This Class B digital apparatus complies with Canadian ICES-003.

Cet appareil numérique de la classe B est conforme à la norme NMB-003 du Canada.

Safety Warning for the USA and Canada

If the power cord is not supplied with the computer, select the proper power cord according to your national electrical specifications.

USA: use a UL listed type SVT detachable power cord.

Canada: use a CSA certified detachable power cord.

For your safety, never remove the PC's cover without first removing the power cord and any connection to a telecommunication network. Always replace the cover before switching on again.

Si le cordon secteur n'est pas livré avec votre ordinateur, utiliser un cordon secteur en accord avec votre code électrique national.

Canada: utiliser un cordon secteur certifié CSA.

Pour votre sécurité, ne jamais retirer le capot de l'ordinateur sans avoir préalablement débranché le cordon secteur et toute connexion à un réseau de télécommunication. N'oubliez pas de replacer le capot avant de rebrancher le cordon secteur.

Notice for the Netherlands



Bij dit apparaat zijn batterijen geleverd. Wanneer deze leeg zijn, moet U ze niet weggooiden maar inleveren als KCA.

Hinweis für Deutschland: Geräuschemission

Lärmangabe nach Maschinenlärmmittelverordnung - 3 GSGV (Deutschland):

LpA < 70 dB am Arbeitsplatz bei normalem Betrieb nach DIN 45635 T.19

(under normal use in the workplace, as per ISO 7779).

Notice for Japan

この装置は、情報処理装置等電波障害自主規制協議会（VCCI）の基準に基づくクラスB情報技術装置です。この装置は、家庭環境で使用することを目的としていますが、この装置がラジオやテレビジョン受信機に近接して使用されると、受信障害を引き起こすことがあります。
取り扱い説明書に従って正しい取り扱いをして下さい。

This equipment is in the Class B category information technology equipment based on the rules of the Voluntary Control Council For Interference by Information Technology Equipment (VCCI). Although aimed for residential area operation, radio interference may be caused when used near a radio or TV receiver. Read the instructions for correct operation.

Notice for Korea

최소 3m 떨어진 거리에서

이 기기는 대한민국 전 국토를 제외한
과거 도서, 중계지역에서 일부 무선 지역에서
사용할 수 있습니다.

TELECOM REGULATORY STATEMENTS

PART 68 FCC Compliance Statement (USA)

This equipment complies with Part 68 of the FCC Rules. A label is attached to the equipment that contains, among other information, its FCC registration number and ringer equivalence number (REN). If requested, this information must be provided to the telephone company.

An FCC compliant telephone cord and modular plug is provided with this equipment. This equipment is designed to be connected to the telephone network or premises wiring using a compatible modular jack, which is FCC part 68 compliant.

Connection to the telephone network should be made by using standard modular telephone jack of type RJ11.

The REN is useful to determine the quantity of devices that may be connected to the telephone line and still have all of those devices ring when your telephone number is called. In most, but not all areas, the sum of the RENs should not exceed five (5.0). To be certain of the number of devices that may be connected to the line, as determined by the total RENs, contact the telephone company to determine the maximum REN for the calling area.

If this equipment causes harm to the telephone network, the telephone company may discontinue your service temporarily. If advance notice is not practical, the telephone company will notify the customer as soon as possible. Also, you will be advised of your right to file a complaint with the FCC if you believe it is necessary.

The telephone company may make changes in its facilities, equipment, operations, or procedures that could affect the operation of the equipment. If this happens, the telephone company will provide advance notice in order for you to make the necessary modifications in order to maintain uninterrupted service.

In the event this equipment should fail to operate properly, disconnect the unit from the telephone line. Try using another FCC approved telephone in the same telephone jack. If the trouble persists, call the telephone company repair service bureau. If the trouble does not persist and appears to be with this unit, disconnect the unit from the telephone line and discontinue use of the unit until it is repaired. Please note that the telephone company may ask that you disconnect the equipment from the telephone network until the problem has been corrected or until you are sure that the equipment is not malfunctioning.

The user must use the accessories and cables supplied by the manufacturer to get optimum performance from the product.

No repairs may be done by the customer.

If trouble is experienced with this equipment, please contact your authorized support provider for repair and warranty information. If the trouble is causing harm to the telephone network, the telephone company may request you remove the equipment from the network until the problem is resolved.

This equipment cannot be used on telephone company provided coin service. Connection to Party Line Service is subject to state tariffs.

When programming and/or making test calls to emergency numbers:

- Remain on the line and briefly explain to the dispatcher the reason for the call.
- Perform such activities in the off-peak hours such as early morning or late evenings.

The Telephone Consumer Protection Act of 1991 makes it unlawful for any person to use a computer or other electronic device to send any message via a telephone facsimile machine unless such message clearly contains, in a margin at the top or bottom of each transmitted page or on the first page of the transmission, the date and time it is sent and an identification of the business, other entity, or individual sending the message and the telephone number of the sending machine of such business, other entity, or individual.

In order to program this information into your facsimile, refer to your communications software user manual.

Industry of Canada Notice

The Industry of Canada label identifies certified equipment. This certification means that the equipment meets certain telecommunications network prospective, operational and safety requirements. The department does not guarantee the equipment will operate to the user's satisfaction.

Before installing this equipment, make sure you are permitted to connect it to the facilities of the local Telecommunications Company. You must install the equipment using an acceptable method of connection. In some cases you may also extend the company's inside wiring for single line individual service by means of certified connector assembly (telephone extension cord). You should be aware, however, that compliance with the above conditions may not prevent degradation of service in some situations.

Repairs to certified equipment should be made by an authorized Canadian maintenance facility designed by the supplier. Any repairs or alterations made by a user to this equipment or equipment malfunctions, may give the telephone communications company cause to request the user to disconnect the equipment.

For your own protection, make sure that the electrical ground connections of the power utility, telephone lines and internal metallic water pipes systems, if present, are connected together. This precaution may be particularly important in rural areas.

Caution: Do not attempt to make electrical ground connections yourself, contact the appropriate electric inspection authority or an electrician.

The Ringer Equivalence Number (REN) assigned to each terminal device provides an indication of the maximum number of terminals allowed to be connected to a telephone interface. The termination on an interface may consist of any combination of devices subject only to the requirement that the sum of the Ringer Equivalence Numbers of all devices does not exceed 5.

PAN European Regulatory Note

The equipment has been approved under CTR21. For such products, the following statement is required:

This equipment has been designed to work with all countries' telephone networks in Europe. Network compatibility is dependent on internal software settings. Contact your vendor if it is necessary to use the equipment on a different telephone network or for further product support contact your authorized support provider on the phone numbers provided in the support and warranty documentation provided with the PC.

Regulatory Information

This equipment has been approved in accordance with Council Decision 98/482/EC for Pan European single terminal connection to the Public Switched Telephone Network (PSTN). However, due to differences between individual PSTNs provided in different countries the approval does not, of itself, give an unconditional assurance of successful operation on every PSTN network termination point.

In the event of problems, you should contact your equipment supplier in the first instance.

Dieses Geraet wurde gemaess der Entscheidung 98/482/EG des Rates europaweit zur Anschaltung als einzelne Endeinrichtung an das oeffentliche Fernsprechnetz zugelassen. Aufgrund der zwischen den oeffentlichen Fernsprechnetzen verschiedener Staaten bestehenden Unterschiede Stellt diese Zulassung an sich jedoch keine unbedingte Gewaehr fuer einen erfolgreichen Betrieb des Geraets an jedem Netzabschlusspunkt dar. Falls beim Betrieb Probleme auftreten, sollten Sie sich zunaechst an ihren Fachhaendler wenden.

Cet équipement a reçu l'agrément, conformément à la décision 98/482/CE du Conseil, concernant la connexion paneuropéenne de terminal unique aux Réseaux Téléphoniques Publics Commutés (RTPC). Toutefois, comme il existe des différences d'un pays à l'autre entre les RTPC, l'agrément en soi ne constitue pas une garantie absolue de fonctionnement optimal à chaque point de terminaison du réseau RTPC.

En cas de problème, vous devez contacter en premier lieu votre fournisseur.

La presente apparecchiatura terminale è stata approvata in conformità della decisione 98/482/CE del Consiglio per la connessione paneuropea come terminale singolo ad una rete analogica PSTN. A causa delle differenze tra le reti dei differenti paesi, l'approvazione non garantisce però di per sé il funzionamento corretto in tutti i punti di terminazione di rete PSTN.

In caso di problemi contattare in primo luogo il fornitore del prodotto.

Este equipo ha sido homologado de conformidad con la Decisión 98/482/CE del Consejo para la conexión paneuropea de un terminal simple a la red telefónica pública conmutada (RTPC). No obstante, a la vista de la diferencias que existen entre las RTPC que se ofrecen en diferentes países, la homologación no constituye por si sola una garantía in condicional de funcionamiento satisfactorio en todos los puntos de terminación de la red de una RTPC.

En caso de surgir algún problema, procede ponerse en contacto en primer lugar el proveedor de equipo.

Dit apparaat is goedgekeurd volgens Beschikking 98/482/EG van de Raad voor de pan-europese aansluiting van enkelvoudige eindapparatuur op het openbare geschakelde telefoonnetwerk (PSTN). Gezien de verschillen tussen de individuele PSTN's in de verschillende landen, biedt deze goedkeuring op zichzelf geen onvoorwaardelijke garantie voor een succesvolle werking op elk PSTN-netwerk aansluitpunt.

Neem bij problemen in eerste instantie contact op met de leverancier van het apparaat.

Network Compatibility Declaration

This product is designed to interwork with the Public Switched Telecommunication Networks in UK, Ireland, Netherlands, Sweden, Denmark, Finland, Switzerland, Luxembourg, Belgium, France, Germany, Spain, Portugal, Iceland, Greece, Italy, Norway and Austria.

NEW ZEALAND TELECOM WARNINGS

General

The grant of a Telepermit for any item of terminal equipment indicates only that Telecom has accepted that the item complies with minimum conditions for connection to its network. It indicates no endorsement of the product by Telecom, nor does it provide any sort of warranty. Above all, it provides no assurance that any item will work correctly in all respects with another item of Telepermitted equipment of a different make or model, nor does it imply that any product is compatible with all of Telecom's network services.

This equipment does not fully meet Telecom's impedance requirements. Performance limitations may occur when used in conjunction with some parts of the network. Telecom will accept no responsibility should difficulties arise in such circumstances.

This equipment shall not be set up to make automatic calls to the Telecom '111' Emergency Service.

If a charge for local calls is unacceptable, the 'Dial' button should NOT be used for local calls. Only the 7-digits of the local number should be dialled from your telephone. DO NOT dial the area code digit or the '0' prefix.

This equipment may not provide for the effective hand-over of a call to another device connected to the same line.

Important Notice

Under power failure conditions, this telephone may not operate. Please ensure that a separate telephone, not dependent on local power, is available for emergency use.

Some parameters required for compliance with Telecom's Telepermit requirements are dependent on the equipment (PC) associated with this device. The associated equipment shall be set to operate within the following limits for compliance with Telecom's Specification:-

1. (a) There shall be no more than 10 call attempts to the same number within any 30 minute period for any single manual call initiation, and
(b) The equipment shall go on-hook for a period of not less than 30 seconds between the end of one attempt and the beginning of the next attempt.
2. Where automatic calls are made to different numbers, the equipment shall go on-line for a period of not less than 5 seconds between the end of one attempt and the beginning of the next attempt.
3. The equipment shall be set to ensure that calls are answered between 3 and 30 seconds of receipt of ringing.

All persons using this device for recording telephone conversations shall comply with New Zealand law. This requires that at least one party to the conversation is to be aware that it is being recorded. In addition, the Principles enumerated in the Privacy Act 1993 shall be complied with in respect to the nature of the personal information collected, the purpose for its collection, how it is used and what is disclosed to any other party.

Recycling your PC

HP has a strong commitment toward the environment. Your HP Personal Computer has been designed to respect the environment as much as possible. HP can also take back your old PC for recycling when it reaches the end of its useful life. HP has a product take-back program in several countries. The collected equipment is sent to one of HP's recycling facilities in Europe or the USA. As many parts as possible are reused. The remainder is recycled. Special care is taken for batteries and other potentially toxic substances, which are reduced into non-harmful components through a special chemical process. If you require more details about HP's product take-back program, contact your local dealer or your nearest HP Sales Office.

HP Hardware Warranty

Important Before claiming warranty assistance, you should (a) read thoroughly the troubleshooting information in this manual, (b) **check your precise warranty entitlement by looking at the warranty entitlement label at the rear of this manual** and (c) check your product receipt to ensure you are still within the product warranty period.

General

This HP Hardware Warranty statement gives you, the customer, express warranty rights from HP, the Manufacturer. Please read the rest of this manual for your product-*specific* warranty entitlements. In addition, you may also have other legal rights under applicable local law or special written agreement with HP.

FOR CONSUMER TRANSACTIONS IN AUSTRALIA AND NEW ZEALAND, THE WARRANTY TERMS CONTAINED IN THIS STATEMENT, EXCEPT TO THE EXTENT LAWFULLY PERMITTED, DO NOT EXCLUDE, RESTRICT, OR MODIFY BUT ARE IN ADDITION TO THE MANDATORY STATUTORY RIGHTS APPLICABLE TO THE SALE OF THIS PRODUCT TO YOU. THE LAWS OF YOUR COUNTRY MAY PROVIDE FOR DIFFERENT WARRANTY RIGHTS. IF SO, YOUR HP AUTHORIZED SUPPORT PROVIDER OR HP SALES AND SERVICE OFFICE CAN PROVIDE YOU WITH DETAILS.

Warranty Repair or Replacement

HP Hardware

For the specific warranty period described on the back cover of this guide, HP warrants that your HP Hardware, Accessory or Supply will be free from defects in materials and workmanship. Except as indicated above, however, HP does not warrant that any HP Hardware, Accessory or Supply will operate uninterrupted or error-free.

If, during the product warranty period, HP is unable, within a reasonable time, to repair your product to a condition as warranted, you will be entitled to a refund (in the amount of the product purchase price) upon prompt return of the product to your HP Authorized Support Provider or other HP designate. Unless otherwise stated or agreed upon in writing with HP, all hardware components must be returned for refund with the entire central processor unit. The central processor unit (CPU), keyboard, mouse, and Hewlett-Packard accessories inside the system unit at the time of delivery—such as video adapters, mass storage devices, and interface controllers—are covered by this warranty.

HP products external to the system unit—such as external storage subsystems, monitors, printers, accessories, and other peripherals added at a later stage—are covered by the applicable warranties for those products.

HP software is covered by the HP Software Product Limited Warranty located on page 94 of this guide.

HP does NOT provide support for this product configured as a network server. We recommend HP NetServers for your network server requirements.

Unless otherwise stated, and to the extent permitted by local law, hardware products may contain remanufactured parts (equivalent to new in performance) or parts which may have

been subject to prior incidental use. HP may repair or replace hardware products (i) with products which are equivalent in performance to the products being repaired or replaced but which may have been subject to prior use, (ii) with products which may contain remanufactured parts equivalent to new in performance or parts which may have been subject to prior incidental use, or (iii) with products that are equivalent in function to an original product that has been discontinued.

Non-HP Hardware

Non-HP hardware products and components installed either *before* or *after* the purchase of your HP product, may have different warranty conditions than those of the HP product in which they are installed.

All *non-HP* products or peripherals external to the central processor unit—such as external storage subsystems, monitors, printers, and other peripherals—are covered by the applicable vendor warranties for those products.

Proof of Purchase and Warranty Period

In order to receive service or support for your hardware product for the warranty period specified on the back cover of this guide, proof of the original purchase date of the product may be required in order to establish the warranty period starting date for your product. If proof of purchase is not available, the manufacturer's date (located on the product) becomes the beginning of the warranty period.

Exclusions

Warranty does not apply to defects resulting from: (a) improper or inadequate maintenance or calibration; (b) software, interfacing, parts or supplies not supplied by HP; (c) unauthorized repair, maintenance, modification or misuse; (d) operation outside of the published operating specifications for the product; (e) improper site preparation or maintenance; (f) virus infection; or (g) such other exclusions as may be expressly set forth in this Warranty Statement.

Limitation of Implied Warranties

TO THE EXTENT ALLOWED BY APPLICABLE LOCAL LAW, ANY IMPLIED WARRANTY BY THE MANUFACTURER OF MERCHANTABILITY FOR FITNESS FOR A PARTICULAR PURPOSE OR OTHER IMPLIED WARRANTIES ARE HEREBY LIMITED TO THE DURATION OF THE EXPRESS WARRANTY SET FORTH ABOVE.

Exclusive Remedy

TO THE EXTENT ALLOWED BY APPLICABLE LOCAL LAW, THE REMEDIES IN THIS WARRANTY STATEMENT ARE YOUR SOLE AND EXCLUSIVE REMEDIES. EXCEPT AS INDICATED ABOVE, IN NO EVENT WILL HP BE LIABLE FOR LOSS OF DATA OR FOR DIRECT, SPECIAL, INCIDENTAL, CONSEQUENTIAL (INCLUDING LOST PROFIT) OR OTHER DAMAGE, WHETHER BASED IN CONTRACT, TORT OR OTHERWISE.

HP Hardware Warranty Options

IMPORTANT

THESE HP HARDWARE WARRANTY OPTIONS ARE SPECIFIC TO THE HP HARDWARE PRODUCT PROVIDED TO YOU. THEY COMPLEMENT THE GENERAL HARDWARE AND SOFTWARE WARRANTY STATEMENTS FOUND IN THIS GUIDE AND SUPERSEDE ANY WARRANTY TERMS THAT MAY BE FOUND ONLINE, OR IN ANY DOCUMENTATION OR OTHER MATERIALS CONTAINED IN THE COMPUTER PRODUCT PACKAGING.

Warranty Entitlements
5-Year Limited Hardware Warranty: 5-Year Free Parts Exchange Service
5-Year Limited Hardware Warranty: 5-Year On-Site Service
3-Year Limited Hardware Warranty: 3-Year On-Site Service
3-Year Limited Hardware Warranty: 1-Year On-Site Service, 3-Year Free Parts Exchange Service.
3-Year Limited Hardware Warranty: 3-Year Free Parts Exchange Service
3-Year Limited Hardware Warranty: 3-Year Return for Repair Service
1-Year Limited Hardware Warranty: 1-Year On-Site Service
1-Year Limited Hardware Warranty: 1-Year Free Parts Exchange Service
30-Day Limited Hardware Warranty: Free Parts Exchange or Product Return Service

HP warrants this hardware product against defects in materials and workmanship, for *either* the *Standard Warranty Entitlement* **or** one (1) of the *Other Warranty Entitlements* above, from the date of purchase.

To determine or verify the warranty entitlement for your specific product, refer to the **Warranty Entitlement Information** provided on the back cover of this guide.

Note

Neither HP nor any of its designates guarantee that all of the above Warranty Entitlements will be available in your country. Consult your local HP Sales and Service Office or HP Authorized Support Provider for Warranty Entitlements available in your country.

Warranty Entitlement Descriptions

5-Year Limited Hardware Warranty:

5-Year Free Parts Exchange Service

- Free parts exchange service for the central processor unit, keyboard and mouse provided by an HP Sales and Service Center or an HP Authorized Support Provider, during the five-year product warranty period.

5-Year Limited Hardware Warranty:***5-Year On-Site Service***

- On-site service for the central processor unit, including free parts exchange and labor, provided by an HP Sales and Service Center representative or an HP Authorized Support Provider, during the five-year product warranty period.
- Free parts exchange service for the central processor unit, keyboard, and mouse, provided by an HP Sales and Service Center or an HP Authorized Support Provider, during the five-year product warranty period.

3-Year Limited Hardware Warranty:***3-Year On-Site Service***

- On-site service for the central processor unit, including free parts exchange and labor, provided by an HP Sales and Service Center representative or an HP Authorized Support Provider, during the three-year product warranty period.
- Free parts exchange service for the keyboard, and mouse provided by an HP Sales and Service Center or an HP Authorized Support Provider, during the three-year product warranty period.

3-Year Limited Hardware Warranty:***One Year On-Site, 3-Year Free Parts Exchange Service***

- On-site service for the central processor unit, including free parts exchange and labor, provided by an HP Sales and Service Center representative or an HP Authorized Support Provider, during the *first year* of the product warranty period.
- Free parts exchange service for the central processor unit, provided by an HP Sales and Service Center or an HP Authorized Support Provider, during the *three-year* product warranty period.
- For HP Kayak PC Workstations: Free parts exchange service for the product keyboard and mouse, provided by an HP Sales and Service Center or an HP Authorized Support Provider, during the *three year* product warranty period.
- HP Vectra & Brio PCs: Free parts exchange service for the product keyboard and mouse, provided by an HP Sales and Service Center or an HP Authorized Support Provider, during the *first* year of the product warranty period.

3-Year Limited Hardware Warranty:***3-Year Free Parts Exchange Service***

- Free parts exchange service for the central processor unit, keyboard and mouse provided by an HP Sales and Service Center or an HP Authorized Support Provider, during the three-year product warranty period.

3-Year Limited Hardware Warranty:***3-Year Return for Repair Service***

- Return For Repair service for the central processor unit, including free parts exchange and labor, provided by an HP Sales and Service Center or an HP Authorized Support Provider during the three-year product warranty period.
- Free parts exchange service for the central processor unit, keyboard and mouse provided by an HP Sales and Service Center or HP Authorized Support Provider, during the three-year product warranty period.

1-Year Limited Hardware Warranty:

1-Year On-Site Service

- On-site service for the central processor unit, including free parts exchange and labor, provided by an HP Sales and Service Center representative or an HP Authorized Support Provider representative, during the one-year product warranty period.
- Free parts exchange service for the central processor unit, keyboard, and mouse, provided by an HP Sales and Service Center or an HP Authorized Support Provider, during the one-year product warranty period.

1-Year Limited Hardware Warranty:

1-Year Free Parts Exchange Service

- Free parts exchange service for the central processor unit, keyboard and mouse provided by an HP Sales and Service Center or an HP Authorized Support Provider, during the one-year product warranty period.

30-Day Limited Hardware Warranty:

30-day Free Parts Exchange or Product Return Service

- Free parts exchange service or return of the entire product, including keyboard and mouse within 30 days of product purchase, to the HP Authorized Support Provider from where the product was purchased. You may be asked for proof of purchase date.

HP Validation and Service Options

If HP receives notice of a defect in your HP hardware product during the hardware product's warranty period, HP or its designate may, at its option and depending on warranty entitlement:

- 1 Repair the parts which prove to be defective *OR*
- 2 Replace the parts which prove to be defective *OR*
- 3 Provide you, the end-user customer, with the appropriate part(s) required for repair. In this event, HP may:
 - Provide you with written instructions for replacing the defective part(s).
 - Provide free telephone assistance for installation of the replacement component.
 - Prepay shipping charges, duties, and taxes for replacement parts sent to you as well as for any parts that HP asks to be returned. You will be billed for any defective part(s) not returned as requested by HP.

Note

HP reserves the right to validate any claims of defective products or components before repairing or replacing such products or components.

Obtaining Warranty Service

Customer Responsibilities Before Contacting HP

Before contacting HP for warranty service for your HP product, please prepare by:

- Consulting the troubleshooting section of your User's Guide.
- Running the diagnostic software (if installed on your system) to diagnose your product and to obtain information that will be requested by a support agent.
- Troubleshooting your system using support information provided on the HPWorldwide

Web support site at:

- For HP Vectra PCs <http://www.hp.com/go/vectrasupport>
- For HP Brio PCs <http://www.hp.com/go/briosupport>
- For HP Kayak PC Workstations <http://www.hp.com/go/kayaksupport>

- Locating your proof of purchase date, indicated on your receipt, invoice, etc.
- Having immediate access to the defective product for potential online or telephone troubleshooting by an HP service agent.
- Securing all proprietary and confidential information and maintaining a procedure external to the products for reconstruction of lost or altered files, data, or programs if on-site service is applicable.

HP Telephone Support Services

Free telephone support for your hardware product is available from HP Customer Care Centers (refer to page 98 for contact telephone numbers) during the product warranty period under the following conditions:

- You may request support for basic configuration, setup, and troubleshooting of your hardware product during the first year of the product warranty period.
- You may request warranty support for your HP hardware product during the product warranty period.
- You may be required to provide proof of the purchase date for the product requiring support in order to determine warranty entitlement.

Note Before dispatching an HP Service Representative or replacement part, HP will attempt to resolve your support issue via the telephone.

HP Lifeline Telephone Support, a fee-based service, is available for telephone assistance not covered by the warranty of your hardware product or for assistance for your hardware product outside of the warranty period of your product.

Your call can either be charged to your phone bill at a per-minute rate or to your credit card (Visa, Mastercard or American Express) at a flat fee.

The charge begins AFTER you have been put in contact with a support technician. If your problem is found to be covered by the HP Hardware Warranty, no charge will be applied.

In the
U.S.A

Please call the appropriate number listed below.

Number	Method of Payment	Charge Type
1 (900) 555-1500	Charged to phone bill	per-minute rate
1 (800) 999-1148	Charged to credit card	Flat fee

Elsewhere

Please call your local HP Customer Care Center (refer to page 98 for contact telephone numbers).

Obtaining On-Site Service

If your product is eligible for on-site warranty service, you must either contact an HP Customer Care Center, an HP Sales and Service Office or a participating HP Authorized Support Provider. You may be required to supply proof of the purchase date.

On-site visits resulting from defects in non-HP products—whether internal or external to the central processor unit—are subject to standard per-incident travel and labor charges.

On-site service visits are subject to the following conditions:

- You must verify that the latest version of the BIOS is installed on your product. You may be asked to install the latest version of the BIOS before an HP Sales and Service Center representative or HP Authorized Support Provider representative is dispatched to your site.
- You must provide: access to the product; adequate working space and facilities within a reasonable distance of the product; access to and use of all information and facilities determined necessary by HP to service the product; and operating supplies and consumables such as you would use during normal operation.
- You, or a representative for you, must be present at all times. You must state if the product is being used in an environment which poses a potential health hazard to repair personnel. HP or the servicing dealer may require that the product be maintained by customer personnel under direct HP or dealer supervision.
- On-site service for this product is restricted or unavailable in certain locations. In HP Excluded Travel Areas — areas where geographical obstacles, undeveloped roads, or unsuitable public transportation prohibit routine travel— service is provided on a negotiated basis at extra charge.
- Response time for on-site service in an HP Service Travel Area is normally next business day (excluding HP holidays) for HP Travel Zones 1-3 (generally 100 miles or 160 km from the HP office). Response time is second business day for Zones 4 and 5 (200 miles, 320 km); third business day for Zone 6 (300 miles, 480 km); and negotiated beyond Zone 6. Worldwide Customer Support Travel information is available from any HP Sales and Service Office. Response time for on-site service is subject to changes from standard conditions based upon non-local parts availability.
- Travel restrictions and response times for HP Authorized Support Providers are defined by the participating HP Authorized Support Providers.

Obtaining Free Parts Exchange Service

For Free Parts Exchange service, you must contact either an HP Customer Care Center, an HP Sales and Service Office, or a participating HP Authorized Support Provider. You will be sent the necessary replacement parts for performing any repairs yourself.

In addition, obtaining Free Parts Exchange service is subject to the following conditions:

- If you contact an HP Customer Care Center and you are to receive a replacement part, you will *not* be billed for the call. If you are asked to return the entire bundled product for repair, the necessary parts will be provided free of charge; however, you will be billed for labor to repair your product.
- HP reserves the right to validate any claims of defective parts before sending replacements for any such parts.
- You must verify that the latest version of the BIOS is installed on your product. You may be asked to install the latest version of the BIOS before a free replacement part is sent to you.
- HP may provide you with necessary written instructions for replacing the defective part(s).

- HP is not responsible for nor warrants your replacement parts or hardware product against damage resulting from improper installation of replacement parts or repair of your defective product by you or your designate. Therefore, HP recommends that only a qualified computer repair professional install the replacement part or repair your hardware product.
- You will be billed for any additional replacement parts required as a result of improper installation of original replacement part by you or your designate.
- You will be billed for any defective part(s) not returned as requested by HP.

Obtaining Return for Repair Service

To obtain Return For Repair service, you must return your product to an HP Repair Center or HP Authorized Support Provider within the product warranty period. Once the product has been repaired, it will be returned free of charge to the address you designate.

Return For Repair service is subject to the following conditions:

- Running the HP diagnostic software provided with your product before returning your product for repair service is recommended.
- You are required to return the complete product in an acceptable and repairable condition.
- Return for Repair service is limited to the repair of hardware failures only.
- Returned product failures caused by non-HP products - whether internal or external to the system processor unit - are subject to standard per-incident repair charges.
- If a hardware failure is not found, you will be billed for the service provided.
- You may be required to provide proof of the purchase date of your product before warranty service will be provided.

Obtaining Product Return Service

For Product Return Service, you must contact HP or an HP Authorized Support Provider within 30 days of the product purchase date.

- You may be required to justify the reason for returning the product.
- You may also be asked for proof of the product purchase date.
- If the product cannot be repaired, you must return the defective product to the HP Authorized Support Provider from whom you purchased your product in order to exchange it for a non-defective product or to receive a refund.
- Unless otherwise stated or agreed upon in writing with HP, all hardware components must be returned for refund with the entire central processor unit.

HP Software Limited Warranty

THIS HP SOFTWARE LIMITED WARRANTY SHALL COVER ALL SOFTWARE, INCLUDING OPERATING SYSTEM SOFTWARE, THAT IS PROVIDED TO YOU AS PART OF THE HP PRODUCT. IT SHALL SUPERSEDE ANY OTHER SOFTWARE WARRANTY STATEMENT THAT MAY BE INCLUDED IN THIS HP PRODUCT OR MAY BE FOUND ONLINE.

HP Software

Ninety-Day Limited Software Warranty

HP warrants for a period of NINETY (90) DAYS from the date of the purchase that all pre-installed HP software will execute their programming instructions when all files are properly installed. HP does not warrant that the software will be uninterrupted or error free. In case of software failure to execute its programming instructions during the warranty period, customer's remedy will be the replacement of software provided by HP or a refund upon return of the product and all copies of software, installation instructions and assistance.

Removable Media (if supplied)

HP warrants the removable media, if supplied, upon which this product is recorded to be free from defects in materials and workmanship under normal use for a period of NINETY (90) DAYS from the date of purchase. Customer's remedy in case of defect will be the replacement of media provided by HP or a refund upon return of the product and destruction of all other non-removable media copies of the software.

Other Software (if supplied)

All other software is warranted by the software vendor and is *not* warranted by HP.

Operating System (if supplied)

HP warrants for a one (1) year period from the date of the purchase the installation and configuration of the pre-installed version of the operating system. HP does not warrant that the software will be uninterrupted or error free. In the event of software failure to execute its programming instructions during the warranty period, HP will provide the Customer with non-defective software along with re-installation instructions or assistance.

HP Service Procedures

Notice of Warranty Claims

Customer must notify HP in writing of any warranty claim not later than thirty (30) days after the expiration of the warranty period.

Limitation of Warranty

HP makes no other express warranty, whether written or oral with respect to this product. Any implied warranty of merchantability or fitness for a particular purpose is limited to the 90-day duration of this written warranty.

HP is not liable in case of misuse, unauthorized modification, improper maintenance, or defects resulting from unauthorized use with non HP equipment.

Limitation of Liability and Remedies

THE REMEDIES PROVIDED ABOVE ARE CUSTOMER'S SOLE AND EXCLUSIVE REMEDIES. IN NO EVENT SHALL HP BE LIABLE FOR ANY DIRECT, INDIRECT, SPECIAL, INCIDENTAL OR CONSEQUENTIAL DAMAGES (INCLUDING LOST PROFIT) WHETHER BASED ON WARRANTY, CONTRACT, TORT OR ANY OTHER LEGAL THEORY. This warranty in no way effects Customers right under statutory law.

Obtaining Warranty Service

Warranty Service may be obtained from the nearest HP sales office or in other locations indicated on HP's Web Site.

HP Software License Agreement

Your HP product contains software programs.

CAREFULLY READ THIS LICENSE AGREEMENT AND LIMITED WARRANTY STATEMENT BEFORE PROCEEDING TO OPERATE THIS EQUIPMENT. RIGHTS IN THE SOFTWARE ARE OFFERED ONLY ON THE CONDITION THAT THE CUSTOMER AGREES TO ALL TERMS AND CONDITIONS OF THE LICENSE AGREEMENT. PROCEEDING TO OPERATE THE EQUIPMENT INDICATES YOUR ACCEPTANCE OF THESE TERMS AND CONDITIONS. IF YOU DO NOT AGREE WITH THE TERMS OF THE LICENSE AGREEMENT, YOU MUST NOW EITHER REMOVE THE SOFTWARE FROM YOUR HARD DISK DRIVE AND DESTROY THE MASTER DISKETTES, OR RETURN THE COMPLETE HP PRODUCT AND SOFTWARE FOR A FULL REFUND. PROCEEDING WITH CONFIGURATION SIGNIFIES YOUR ACCEPTANCE OF THE LICENSE TERMS. UNLESS OTHERWISE STATED BELOW, THIS HP SOFTWARE LICENSE AGREEMENT SHALL GOVERN THE USE OF ALL SOFTWARE THAT IS PROVIDED TO YOU AS PART OF THE HP PRODUCT. IT SHALL SUPERSEDE ANY OTHER SOFTWARE WARRANTY STATEMENT THAT MAY BE INCLUDED IN THIS HP PRODUCT OR MAY BE FOUND ONLINE.

Note

Operating system and software applications by Microsoft are licensed to you under the Microsoft License Agreement contained in the Microsoft documentation or displayed on your screen when Microsoft Software Products are launched. The following License Terms govern the use of the software:

USE. Customer may use the software on any one HP product. Customer may not network the software or otherwise use it on more than one HP product. Customer may not reverse assemble or decompile the software unless authorized by law.

COPIES AND ADAPTATIONS. Customer may make copies or adaptations of the software (a) for archival purposes or (b) when copying or adaptation is an essential step in the use of the software with an HP product so long as the copies and adaptations are used in no other manner.

OWNERSHIP. Customer agrees that he/she does not have any title or ownership of the software, other than ownership of the physical media. Customer acknowledges and agrees that the software is copyrighted and protected under the copyright laws. Customer acknowledges and agrees that the software may have been developed by a third party software supplier named in the copyright notices included with the software, who shall be authorized to hold the Customer responsible for any copyright infringement or violation of this Agreement.

PRODUCT RECOVERY CD-ROM. If your HP product was shipped with a product recovery CD-ROM:

(i) The product recovery CD-ROM and/or support utility software may only be used for restoring the hard disk of the HP product with which the product recovery CD-ROM was originally provided.

(ii) The use of any operating system software by Microsoft contained in any such product recovery CD-ROM shall be governed by the Microsoft License Agreement.

TRANSFER OF RIGHTS IN SOFTWARE. Customer may transfer rights in the software to a third party only as part of the transfer of all rights and only if Customer obtains the prior agreement of the third party to be bound by the terms of this License Agreement. Upon such a transfer, Customer agrees that his/her rights in the software are terminated and that he/she will either destroy his/her copies and adaptations or deliver them to the third party.

SUBLICENSING AND DISTRIBUTION. Customer may not lease, sublicense the software or distribute copies or adaptations of the software to the public in physical media or by telecommunication without the prior written consent of Hewlett-Packard.

TERMINATION. Hewlett-Packard may terminate this software license for failure to comply with any of these terms provided Hewlett-Packard has requested Customer to cure the failure and Customer has failed to do so within thirty (30) days of such notice.

UPDATES AND UPGRADES. Customer agrees that the software does not include updates and upgrades which may be available from Hewlett-Packard under a separate support agreement.

EXPORT CLAUSE. Customer agrees not to export or re-export the software or any copy or adaptation in violation of the U.S. Export Administration regulations or other applicable regulation.

U.S. GOVERNMENT RESTRICTED RIGHTS. Use, duplication, or disclosure by the U.S. Government is subject to restrictions as set forth in subparagraph (c)(1)(ii) of the Rights in Technical Data and Computer Software clause in DFARS 252.227-7013. Hewlett-Packard Company, 3000 Hanover Street, Palo Alto, CA 94304 U.S.A. Rights for non-DOD U.S. Government Departments and Agencies are as set forth in FAR 52.227-19(c)(1,2).

International Warranty

This warranty is extended worldwide under certain conditions to products purchased from HP or an HP Authorized Reseller which are reshipped by the original purchaser either for use by the original purchaser or provided as an incidental part of systems integrated by the original purchaser. When available in the country of use, service is provided in the same manner as if the product was purchased in that country and can only be provided in countries where the product is designed to operate. Also, standard warranty service response time is subject to change due to local parts availability. *If the product is not normally sold by HP in the country of use, it may need to be returned to the country of purchase for service.*

Please check with your local HP Sales and Service Office or HP Authorized Support Provider for more information.

HP Year 2000 Warranty

YEAR 2000 WARRANTY FOR HP PRODUCTS

Subject to all of the terms and limitations of the Warranty specified in the HP **Warranty Entitlement** information on the back cover of this guide, HP warrants that this HP Product will be able to accurately process date data (including, but not limited to, calculating, comparing, and sequencing) from, into, and between the twentieth and twenty-first centuries, and the years 1999 and 2000, including leap year calculations, when used in accordance with the product documentation provided by HP (including any instructions for installing patches or upgrades), provided that all other products (e.g. hardware, software, firmware) used in combination with such HP Product(s) properly exchange date data with it. The duration of the Year 2000 warranty extends through January 31,2001.

DISCLAIMER FOR NON-HP PRODUCTS

Hewlett-Packard makes no representation or warranty about the Year 2000 readiness of non-HP products including pre-installed operating systems or application software. Customer should contact the software manufacturer directly to determine if any additional actions by Customer are necessary to ensure compliance.

Note

MICROSOFT HAS INDICATED THAT MANY OF ITS OPERATING SYSTEM SOFTWARE PRODUCTS AND APPLICATIONS REQUIRE CUSTOMER INSTALLATION OF SOFTWARE PATCHES FOR YEAR 2000 (Y2K) COMPLIANCE AND MAY REQUIRE ADDITIONAL PATCHES IN THE FUTURE. THE NEED FOR SUCH PATCHES MOST LIKELY APPLIES TO THE OPERATING SYSTEM SOFTWARE AND ANY MICROSOFT APPLICATIONS SHIPPED WITH THIS PRODUCT.

FOR MORE YEAR 2000 INFORMATION THE CUSTOMER IS URGED TO CONTACT MICROSOFT AT 1-888-MSFTY2K (IN U.S.A AND CANADA), THEIR LOCAL MICROSOFT OFFICE (ALL OTHER COUNTRIES) OR TO VISIT MICROSOFT'S WEB SITE AT: www.microsoft.com/y2k.

HP Customer Care Center Phone Numbers

HP Customer Care Centers can help you solve hardware issues related to HP products and, if necessary, initiate appropriate service procedures. In the U.S.A, telephone support is available 24 hours a day, 7 days a week. Elsewhere, it is available during normal office hours.

North & Latin America

Argentina	(541) 778 8380
Brazil	(011) 3747 7799 (Sao Paulo) 0800 157751 (other Locations)
Canada	905-206-4663
Chile	800 360 999
Mexico	800 427 6684
United States	(970) 635-1000
Venezuela	800 47 888 (Caracas 207 8488)

Europe, Middle East & Africa

Austria	(+ 43) 0711 420 10 80
Belgium	Dutch (+ 32) 02 626 88 06 French (+ 32) 02 626 88 07
Denmark	(+ 45) 39 29 40 99
English International	(+ 44) 0171 512 52 02
Finland	(+ 358) 0203 472 88
France	(+ 33) 01 43 62 34 34
Germany	(+ 49) 0180 525 81 43 (24PF/min)
Israel	Tel. (+ 972) 9-9524848 Fax. (+ 972) 0 9 9524849
Italy	(+ 39) 02-264 10350
Netherlands	(+ 31) 020 606 87 51
Norway	(+ 47) 22 11 62 99
Poland	Tel. (+ 48) 22 519 0600; Fax. (+ 48) 22 519 0601
Portugal	+(351) 21 317 6333
Russian Federation	(+ 7) 095 797 3520 (Moscow) (+ 7) 812 346 7997(St-Peter) Fax. (+ 7) 095 916 98 35
South Africa	(+ 27) 11 258 9301 (outside RSA) 086 000 1030 (inside RSA)
Spain	(+ 34) 902 32 11 23
Sweden	(+ 46) 08 619 21 70
Switzerland	(+ 41) 084 880 11 11
Turkey	(+ 90) 212-221 6969
United Kingdom	(+ 44) 0870 842 2339

Asia Pacific

Australia	(+ 61-3) 8877-8000
China	+ 86 (0) 10 6564 5959 (800) 810-5959
Hong Kong	(+ 852) 800-96-7729
India	(+ 91-11) 682-6035
Indonesia	(+ 62-21) 350-3408
Japan	(+ 81-3) 3335-8333
Korea, Republic of	(+ 82-2) 3270-0700 080 999 0700 (outside Seoul only)
Malaysia	(+ 60-3) 295-2566
Penang	1 300 88 00 28
New Zealand	(+ 64-9) 356-6640
Philippines	(+ 63-2) 867-3551
Singapore	(+ 65) 272-5300
Taiwan	(+ 886) 2- 2717-0055
Thailand	(+ 66-2) 661-4000
Viet Nam	(+ 84-8) 823-4530

Note: for the most up-to-date list of customer care center numbers, go to: www.hp.com/go/briosupport and select "Assistance".

Other Services

The table below summarizes the services and support available from HP or authorized resellers.

Service	Covers	Period Covered	Response Time	Fee	When Available	Purchase From
HP SupportPack	Parts and labor for HP products.	Variable	Variable	Variable	Within 90 days of delivery.	HP Authorized Reseller.
HP Support Assistant	CD-ROM containing: Product Manuals, Technical Information and Product features.	Released quarterly.	N/A	Annual subscription.	Anytime.	HP.
Electronic Services	Technical information, drivers, utilities, tools and diagnostics.	Anytime.	24-hour access.	No charge.	Anytime.	HP BBS, WWW, CompuServe, America Online.
Technical Phone Support	Basic assistance for system setup, configuration, start-up and hardware diagnosis.	First year (3-years for hardware failure diagnosis).	Business hours.	No charge.	At time of delivery.	HP.
Lifeline Phone Support	Basic assistance for system setup, configuration and start-up.	After first year.	Business hours.	Per-call fee, no time limit.	Anytime after first year.	HP.
HP Network Phone-in Support	Advanced remote technical support for multi-vendor networked environments.	Annual contract.	Business hours: 24-hour/ 7-day service also available.	Annual fee, or minimum fee per incident.	Anytime.	HP Authorized Reseller.
Service Contracts	Technical Support.	Customer defined.	As required.	Annual fee, or fee per incident.	Anytime.	Reseller.

Index

B

- battery
 - replacing 69
- beep codes 35
- BIOS
 - configuring your PC 76
 - setting system defaults 73
 - updating 76
- boot device priority 73

C

- cables in the PC 57
- cards
 - installing 66
- CD-ROM, CD-RW
 - installing 62
- clearing CMOS 74
- CMOS 74
- configuring your PC 76
- connecting
 - keyboard 3
 - monitor 3
 - mouse 3
 - power cords 3
- connectors in the PC 57
- cover
 - removing 49, 51, 53
 - replacing 49, 53, 54

D

- DVD
 - installing 62
 - recommended configuration 28

E

- e-DiagTools

- features 42
- running 42

errors

- at startup 35
- beeps 35
- POST 35
- expansion cards
 - installing 66

F

- FAQs 41
- floppy drive
 - replacing 59

H

- hard drive
 - replacing 60
- hardware diagnostics 42
- help
 - online vi
- HP Brio Assist CD-ROM
 - changing OS 43
 - reinstalling drivers 44
 - running e-DiagTools 44
 - system recovery 43
- HP Brio Center v
- HP Brio support web v
- HP Setup program
 - menus 45
 - setting defaults 73
 - using 45

I

- installing hardware 47

M

- memory

installing 65

N

Notice vi

O

online information vi

online troubleshooting 15

P

passwords 74

PC

 configuring 76

POST errors 35

power supply

 replacing 67

problems

 at startup 35

 audio 33

 FAQs 41

 hardware 23

 identifying 22

 more help 41

 PC beeps 35

 PC doesn't start 19

 PC doesn't work 21

 software 31

 what to do first 18

processor

 replacing 58

R

removing

 cover 49, 53

replacing

 battery 69

 CD-ROM, CD-RW 62

 cover 49, 53

 floppy drive 59

 hard drive 60

 power supply 67

processor 58

system board 55

S

starting

 the PC 10

startup errors 35

startup problems 35

support 79

system board

 replacing 55

T

technical characteristics 77

troubleshooting

 HP Brio Center 15

 what to do first 18

U

updating

 BIOS 76

upgrading your PC 47

using

 CD-RW 14

 DVD 14

 HP Setup program 45

 keyboard 14

 modem 14

 mouse 14

Using Your HP Brio PC 14

W

warranty 79, 86

Windows

 setting up 10

 tour 14

working in comfort 14

Warranty Entitlement Information

(affix label here for other warranty options)

Worldwide:

**3 year International Limited Hardware Warranty:
1 year Next Business Day Onsite, 2 year Parts Exchange
3 year Exchange Keyboard and Mouse**

China:

**3 year International Limited Hardware Warranty:
1 year Next Business Day Onsite, 2 year Return to Bench
3 year Exchange Keyboard and Mouse**

India & Latin America (part numbers ending with "B"):

**1 year Next Business Day Onsite
1 year Exchange Keyboard and Mouse**

For instructions on how to return your product for repair, contact your HP Customer Care Center. Your product will not be accepted for repair unless you first contacted your HP Customer Care Center.

The customer shall prepay all shipping charges, duty and taxes for products returned for HP warranty service. HP shall pay for the return of the product to the customer, except for products returned to the customer in another country.

For HP Customer Care Centers www.hp.com/go/briosupport and select ASSISTANCE.

If You Have a Problem:

- Check the troubleshooting information in this manual and in the online HP Brio Center
- Check you have your product receipt
- Run HP e-DiagTools (see inside manual)
- Check your Warranty Entitlement (see above)
- Contact your local Customer Care Center (see numbers provided inside manual)

Free Manuals Download Website

<http://myh66.com>

<http://usermanuals.us>

<http://www.somanuals.com>

<http://www.4manuals.cc>

<http://www.manual-lib.com>

<http://www.404manual.com>

<http://www.luxmanual.com>

<http://aubethermostatmanual.com>

Golf course search by state

<http://golfingnear.com>

Email search by domain

<http://emailbydomain.com>

Auto manuals search

<http://auto.somanuals.com>

TV manuals search

<http://tv.somanuals.com>