

4937A TRANSMISSION IMPAIRMENT TEST SET

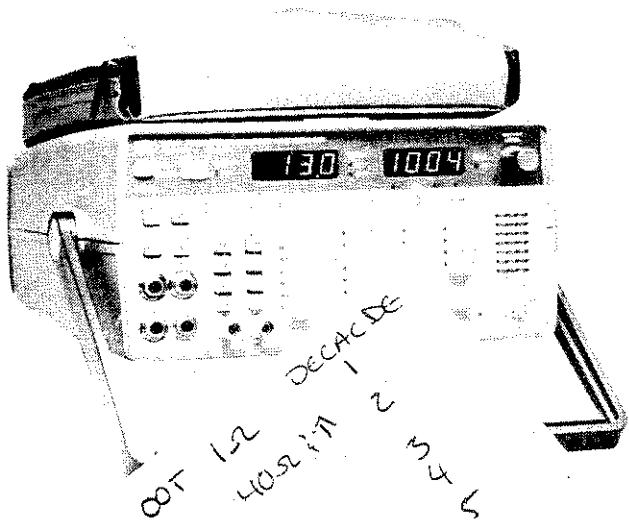



Figure 1-1. Model 4937A Transmission Impairment Measuring Set

SECTION I

GENERAL INFORMATION

1-1. INTRODUCTION

1-2. This Operating and Service Manual contains information required to install, operate, test, adjust, and service the Hewlett-Packard Model 4937A Transmission Impairment Measuring Set. Figure 1-1 shows the instrument and accessories supplied. Throughout the remainder of this manual the Model 4937A will be referred to as HP 4937A or the instrument.

1-3. The Manual part number is listed on the title page. Also listed on the title page of this manual is a Microfiche part number. This number can be used to order 4 X 6 inch microfilm transparencies of the manual. Each microfiche contains up to 96 photo-duplicates of the manual pages. The microfiche package also includes the latest Manual Changes supplement as well as pertinent Service Notes.

1-4. SPECIFICATIONS

1-5. Instrument specifications are listed in table 1-1. These specifications are the performance standards or limits against which the instrument is tested. Supplemental characteristics are shown in the shaded areas or in italics and are intended to provide information useful in the application of the instrument. These specifications are not warranted performance parameters. Performance tests are listed in Section IV of this manual.

1-6. SAFETY CONSIDERATIONS

1-7. This product is a Safety Class 1 instrument (provided with a protective earth terminal). The instrument and manual should be reviewed for safety markings and instructions before operation.

1-8. INSTRUMENTS COVERED BY THIS MANUAL

1-9. Attached to the instrument is a serial number plate. The serial number is in the form: 0000A00000. It is in two parts; the first four digits and the letter are the serial prefix and the last five digits are the suffix. The prefix is the same for all identical instruments; it changes only when a change is made to the instrument. The suffix however, is assigned sequentially and is different for each instrument. The contents of this manual apply to the instruments with the serial number prefix(s) listed under SERIAL NUMBERS on the title page.

1-10. An instrument manufactured after the printing of this manual may have a serial number prefix that is not listed on the title page. This unlisted serial number prefix indicates the instrument is different from those described in this manual. The manual for this newer number is accompanied by a yellow Changes Sheet supplement. This supplement contains "change information" that explains how to adapt the manual to the newer instrument.

HP 4937A
GENERAL INFORMATION

For information concerning a serial number prefix that is not listed on the title page or in the Changes supplement, contact your nearest Hewlett-Packard sales office.

DESCRIPTION

The HP 4937A is a voice band Transmission Impairment Measurement Set that also incorporates signaling capability. These features, combined with the instrument's light weight, provides a portable field service tool for fast, accurate network access testing. The HP 4937A signaling feature is used to verify the proper installation of PBX systems.

The transmission impairment measurements that can be made using the HP 4937A are listed below:

1. Level and Frequency
2. Noise
3. Noise with Tone
4. Signal to Noise
5. Noise to Ground
6. Return Loss

The procedures for using supervisory signaling, and for making the transmission impairment measurements, are described in Section III of this manual.

Supervisory signaling is used to detect or change the state or condition of a subscriber or trunk line. There are two supervisory conditions; on-hook and off-hook. The on-hook condition when the telephone is idle. That is the handset is resting on the cradle and the grounding switch is open.

Off-hook condition is when the telephone is active. That is when the handset is removed from the cradle and the grounding switch is closed.

These on-hook and off-hook conditions provide circuit indications such as circuit idle, circuit seizure, and disconnect.

The HP 4937A can perform the following supervisory signaling functions:

1. Loop start signaling
2. Ground start signaling
3. Loop reverse battery signaling
4. E/M signaling Types I, II, and III
5. Wink

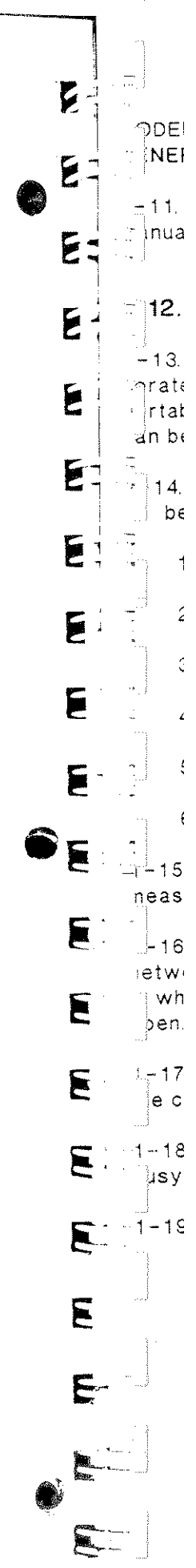

1-20. OPTIONS

The following options are available:

1. Option 001 adds a rechargeable battery pack.
2. Option 002 deletes 900 ohm and adds 150 ohm impedance.
3. Option 910 includes an additional Operating and Service Manual.

1-21. WARRANTY

Instrument warranty is as listed inside of the front cover.

1-22. ACCESSORIES AVAILABLE

1. Test Cord w/310 male to alligator clips, 60 inches, HP P/N 18182A
2. Test Cord w/310 male at both ends, 36 inches, HP P/N 15513A
3. Standard 19-inch rack mounting kit, HP P/N 18132A
4. Ladder bracket, HP P/N 18161A

1-23. RECOMMENDED TEST EQUIPMENT

1-24. Equipment required to maintain the Model 4937A is listed in table 1-2. Other equipment may be substituted if it meets or exceeds the critical specifications listed in the table.

1-25. BATTERY OPERATION (Option 001)

1-26. Instruments with Option 001 have nickel-cadmium batteries that enable the HP 4937A to operate from internal power when in areas where ac power is not available. Typical operating time is 5 hours when the batteries are fully charged. The batteries are trickle charged whenever the instrument is connected to an ac power source and the POWER switch is in the STBY position.

1-27. Regular discharge/charge cycles are recommended to maintain maximum battery capacity. The instrument should be operated until the batteries are discharged (when LOW BATTERY indicator is displayed in the left display) then recharged, at least every 30 days. Normal recharge time is about 14 hours. Typical battery life under normal operating conditions should be at least 100 charge/discharge cycles.

Note

Batteries do not charge when the HP 4937A is operating from an ac source.

Charging the Batteries

The internal battery consists of one 15-volt rechargeable battery pack. To recharge the battery, connect the HP 4937A to an ac power source and press the power switch to STBY (the battery will not charge with the power switch in the ON position). Normal recharge time is about 14 hours.

Charging Temperature

The batteries may be charged at temperatures between +5 degrees C and +40 degrees C (+41 degrees F and +104 degrees F), but will have greater charge capacity if charged between +5 degrees C and +25 degrees C (+41 degrees F and +77 degrees F). At temperatures above +25 degrees C the charge acceptance falls off as shown in figure 1-2. For example, a cell charged at 45 degrees C accepts about 60 to 70 percent of its rated capacity. Temperatures below +5 degrees C cause pressure to build up within the cell as it is charged, which could result in venting of the cell. This can result in permanent degradation of the battery capacity due to loss of electrolyte.

Operating Temperature

Normal operating temperature of the HP 4937A with batteries should be between 0 degrees C and +40 degrees C (+32 degrees F and +104 degrees F). However, there will be a loss of capacity if the device is operated at the extremes. At low temperatures, the batteries cannot fully discharge even when they were fully charged at room temperature. At high temperatures the same effect takes place, but to a lesser degree, in addition to charge acceptance previously mentioned. Figure 1-2 illustrates this effect.

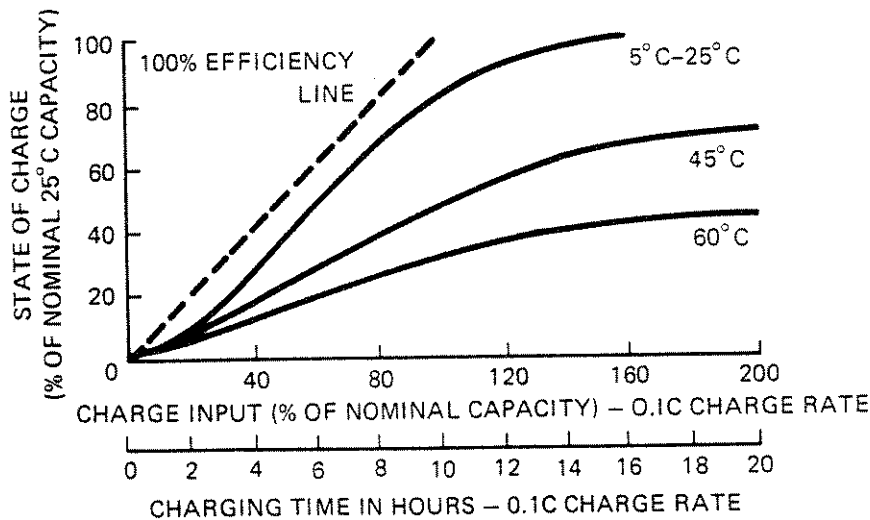

Figure 1-2. Charge Acceptance at Various Temperatures

Table 1-1. Specifications

LEVEL/FREQUENCY

Transmitter

Frequency:
Range: 20 Hz to 9999 Hz
Resolution: 1 Hz
Accuracy: +/-0.005% of output frequency

Preprogrammed functions:
SF Skip: skips the frequency band from 2450-2750 Hz
Frequencies: at power up 404 Hz, 1004 Hz, 2804 Hz, and 2713 Hz

Level:
Range: -40 to +13 dBm
Resolution: 0.1 dB
Accuracy (@ 1004 Hz, -19 dBm to 0 dBm), +/-0.1 dB; (elsewhere) +/-0.2 dB

Flatness (referenced to 1 kHz, in dB)

		Frequency (Hz)			
		20	200	4000	9999
Level (dB)	+13	+1.5, -3.0	+/-0.2	+/-0.2	+/-0.2
	+10	+/-1.0	+/-0.2	+/-0.2	+/-0.2
	-40				

Distortion (in dB from fundamental)

Note: (Includes harmonics, spurious, and background noise within a 3 dB bandwidth of 4 kHz or 4 X f₀ whichever is greater.)

		Frequency (Hz)			
		40	100	4000	9999
Level (dB)	+13	-20	-45	-45	
	+10	-30	-55	-55	
	0	-40	-50	-50	
	-40				

Note: At 1004 Hz, 0 dBm, threshold is more than 65 dB down when using a 4-kHz filter.

Table 1-1. Specifications (cont)

Receiver

Frequency:
 Range: 20 Hz to 9999 Hz
 Resolution: 1 Hz
 Accuracy: +/- 1.0 Hz

Level:
 Range: -60 to +13 dBm
 Resolution: 0.1 dB
 Accuracy: (in dB)

		Frequency (Hz)				
		20	50	200	4000	9999
Level	+13	+/-1.0	+/-0.5	+/-0.2	+/-0.2	+/-0.2
	-40	+/-1.0	+/-0.6	+/-0.4	+/-0.4	+/-0.4
	-60	+/-1.0	+/-0.6	+/-0.4	+/-0.4	+/-0.4

Note: Receiver accuracy not specified below 500 Hz when using 150 ohm termination. (Instruments with option 002.)

Note: At 1004 Hz accuracy is +/- 0.1 dB from -20 to +13 dBm.

Cross Talk: >78 dB isolation @ 4 kHz, decreasing 6 dB per octave above 4 kHz.

Preprogrammed Functions:

Range Hold: Inhibits the autorange from changing from its present setting.

MESSAGE CIRCUIT NOISE

Transmitter: quiet terminated

Receiver:
 Range: 0 to 99 dBm; 150 ohms, lower limit is 7 dB higher (Option 002 instruments only)
 Resolution: 1 dB
 Accuracy: +/- 1 dB from 10 to 99 dBm
 +/- 2 dB from 0 to 10 dBm

Lighting Filters: C-message, and 3 kHz Flat

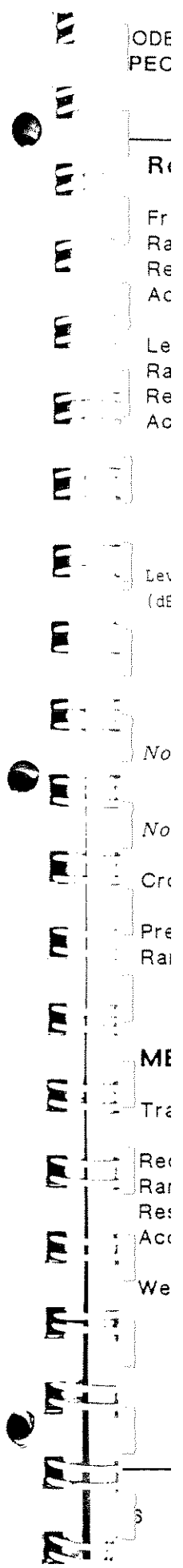

Table 1-1. Specifications (con't)

NOISE WITH TONE

Transmitter:

Frequency: 1004 Hz fixed tone (for other specifications, see Transmitter Frequency)

Receiver:

Notch Filter: >50 dB rejection from 995- to 1025-Hz

Weighting Filters: C-message, and 3 kHz flat

Range: 10 to 99 dBrn (600, 900, and 1200)

Resolution: 1 db

Accuracy: +/-1 dB from 20 to 99 dBrn
+/-3 dB from 10 to 20 dBrn

SIGNAL-TO-NOISE RATIO

Transmitter:

Frequency: 1004 Hz fixed tone (for other specifications, see Level and Frequency)

Receiver:

Signal Level Range: -40 to +13 dBm

Ratio Range: 10 to 45 dB

Resolution: 1 dB

Accuracy: +/-1 dB

NOISE-TO-GROUND

Transmitter: quiet terminated

Receiver:

Weighting Filters: C-message, and 3 kHz flat

Range: 50 to 99 dBrn (600, 900, and 1200 ohms)

Resolution: 1 dB

Accuracy: +/-1.5 dB

RETURN LOSS

2-wire: 600 and 900 ohms only (600 ohms Option 002)

Transmitter:

Level Range: -26 dBm to -2 dBm

Resolution: 0.1 dB

Transmitter Spectra:

Echo, singing return loss low, and singing return loss high spectra all meet the specifications of IEEE standard P743 and Bell System Publication 41009.

Table 1-1. Specifications (con't)

RETURN LOSS 2-wire: (con't)

Receiver:
Range: 0 to 40 dB
Resolution: 0.1 dB
Nominal Hybrid Impedance: 600 ohms (+/-0.1%) or 900 ohms (+/-0.1%) in series with 2.16 microfarads (+/-1%)

Wire: 600 and 900 ohms only (600 ohms Option 002)

Transmitter:
Level Range: -26 dBm to -2 dBm
Resolution: 0.1 dB
Transmitter Spectra:
Singing return loss low, and singing return loss high spectra all meet the specifications of IEEE standard P743 and Bell System Publication 41009.

Receiver:
Range: 0 to 50 dB
Resolution: 0.1 dB
Accuracy: +/-0.5 dB overall
Anshybrid Loss Compensation: -29.9 dB to +29.9 dB in 0.1 dB steps

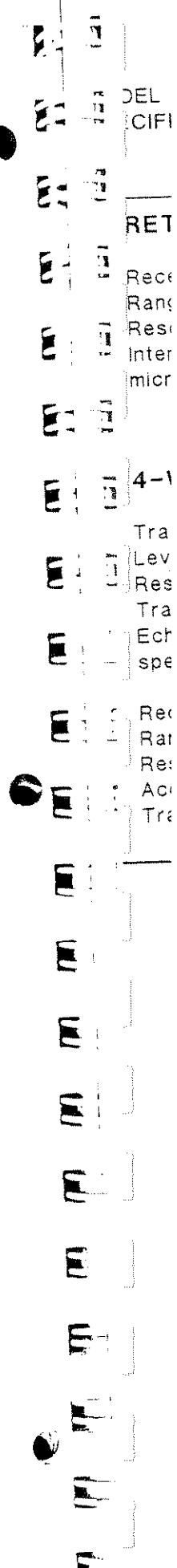

Table 1-1. Specifications (cont)

SUPERVISORY SIGNALING

E/M Signaling

Types: Type I, II, and III (both originate and terminate) Battery: -48 Vdc current limited to 29 mA

Supervision Sensors Threshold Voltages:

<u>E Lead</u>		<u>M Lead</u>			
Voltage:	<-16V = on hook >-16V = off hook	Voltage:	>-16V = on hook <-16V = off hook		
	On-Hook	Off-Hook		On-Hook	Off-Hook
Type I	open	gnd	Type I	gnd	batt
Type II	open	SG	Type II	open	SB
Type III	open	gnd	Type III	SG	SB

Loop Signaling

Types: Loop Start, Ground Start, and Loop Reverse Battery (both originate and terminate)

Hold Circuits: 2, each drawing 27 milliamps at a minimum voltage of 8.5 Vdc
Battery: -48 Vdc with 340 ohms in series, current limited to 29 milliamps

Bridging Loss of Battery:
<0.5 dB from 200 Hz to 500 Hz
<0.3 dB from 500 Hz to 10 kHz

WINK

Idle: 100 msec (nominal)
Off Hook: 200 msec (nominal)

Status indication of on-Hook and off-Hook for both originate and terminate ends of the trunk, except Loop Start which only indicates originate end.

Table 1-1. Specifications (cont)

GENERAL

Maximum DC Blocking: 200 Volts

Impedances: 600, 900, and 1200 ohms, BRIDGE. TRMT and RCV impedances independently selectable

Shielding Loss to 10 kHz: <0.2 dB

Receiver Return Loss: >30 dB from 50 Hz to 4 kHz at 600, 900, and 1200 ohms
>30 dB from 800 Hz to 10 kHz at 150 ohms (option 002)

Longitudinal Balance: >80 dB at 60 Hz; >70 dB at 540 Hz; >60 dB up to 4 kHz decreasing 6 dB per octave to 10 kHz.

Power Requirements: 100 V, 120 V, 220 V, and 240 Vac +5%, -10%, 48-66 Hz

Battery Supply (option): Typically >5.0 hours of continuous operation at 25 C. Complete recharging in 14 hours with unit in STBY.

Temperature Range: 0 C to +55 C, (+32 F to +131 F); 0 C to +40 C with batteries (+32 F to +110 F)

Warm up time @ 20 C for stated accuracy: 5 minutes

Dimensions: 279 mm x 127 mm x 381 mm (5 in. x 11 in. x 15 in.)

Weight: 5.3 kg (12 lbs)
7.6 kg (17 lbs) with batteries

Options

- 001: Adds rechargeable battery pack
- 002: Deletes 900-ohm impedance and adds 150-ohm impedance
- 910: Includes extra Operating and Service Manual

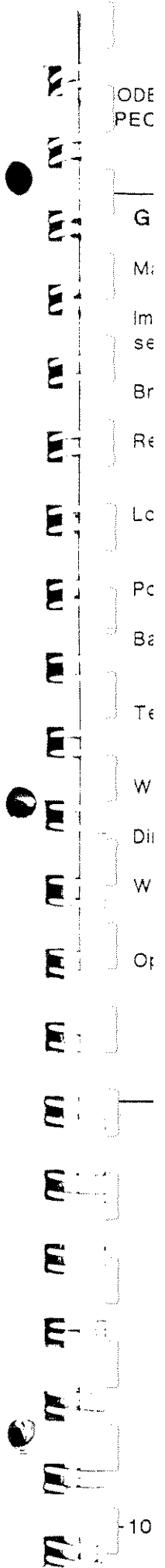

ODE
PEC

G

Ma

Im

se

Br

Re

Lo

Pc

Ba

Te

W

Di

W

Op

MODEL 4937A
SPECIFICATIONS

Table 1-2. Recommended Test Equipment

Instrument	Critical Specifications	Recommended Model	Use
Ac Calibrator	Output: 1mV to 10V Freq: 20Hz to 4 kHz Accy: 0.02%	Fluke 5200A	P,T
Ac Voltmeter	6 1/2 digit, 0.1%	HP 3456A	P,T
Multimeter	dc current	HP 3468A	P,T
Oscilloscope	Dual Chan: 5mV/div	HP 1740A	P,A
Signature Analyzer	CMOS levels Qualifer	HP 5005A	T
Audio Analyzer	20 Hz to 4 kHz	HP 8903A	P,A
Counter	10 kHz	HP 5315A	P
Power Supply	50 volt	HP 6218B	P
Service brackets		HP P/N 1531-0211	
DIP switch		HP P/N 1251-7158	
Resistor, 398 ohm 1%		HP P/N 0698-9100	
Resistor, 600 ohm 1%		HP P/N 0698-7408	
Resistor, 900 ohm 1%		HP P/N 0698-6344	

Note: A=Adjustments
P=Performance Test
T=Troubleshooting

SECTION II INSTALLATION

2-1. INTRODUCTION

2-2. This section provides installation instructions for the Model 4937A TIMS. This section also includes information about initial inspection and damage claims, preparation for use, power requirements, storage and shipment.

2-3. INITIAL INSPECTION

2-4. Inspect the shipping container for damage. If the shipping container or cushioning material is damaged, it should be kept until the contents of the shipment have been checked for completeness and the instrument has been checked mechanically and electrically. The contents of the shipment should be as shown in figure 1-1. The procedures for checking electrical performance are given in Section IV. If the contents are incomplete, if there is mechanical damage or defect, or if the instrument does not pass the performance tests, notify the nearest Hewlett-Packard sales and support office. If the shipping container is damaged, or the cushioning material shows signs of stress, notify the carrier as well as the Hewlett-Packard sales and support office.

2-5. PREPARATION FOR USE

CAUTION

Before connecting this instrument to an ac power source, be sure that the rear panel line module is set to the same voltage as the ac source and that the correct fuse for that ac voltage is installed.

2-6. Power Requirements

2-7. This instrument requires a power source of 100-, 120-, 220-, or 240-Vac, +5% or -10%. Single phase 48- to 66-Hz.

2-8. Option 001 instruments have a battery power supply. The battery pack provides up to 5 hours of continuous operation at 25 degrees C. Complete recharging in 14 hours with unit in STBY mode.

2-9. Line Voltage Selection

2-10. Figure 2-1 provides instruction for line voltage and fuse selection. The line voltage selection and fuse are factory set for 120 Vac operation.

4937A
LLATION

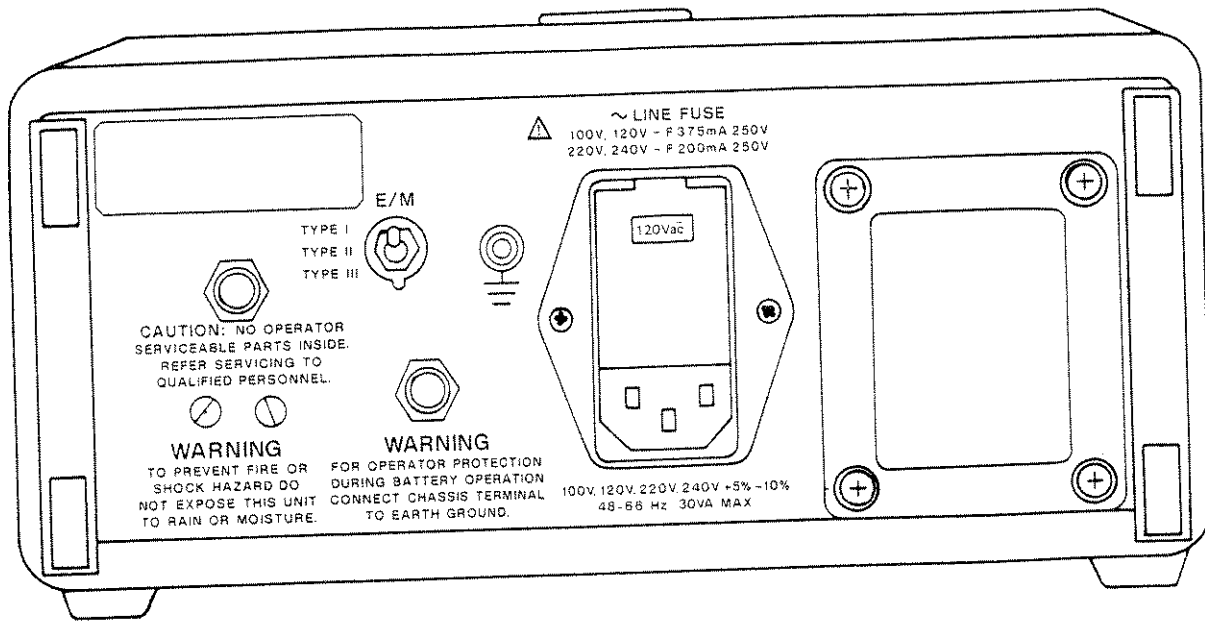

Figure 2-1. Line Voltage Selection

Power Cable

WARNING

Any interruption of the protective (grounding) conductor (inside or outside the instrument) or disconnecting the protective earth terminal can make this instrument dangerous to electrical shock.

2. This instrument is supplied with a three-wire power cable. When connected to an appropriate three-wire ac power receptacle, the cable grounds the instrument. See table 2-1 for available power cables.

13. OPERATING ENVIRONMENT

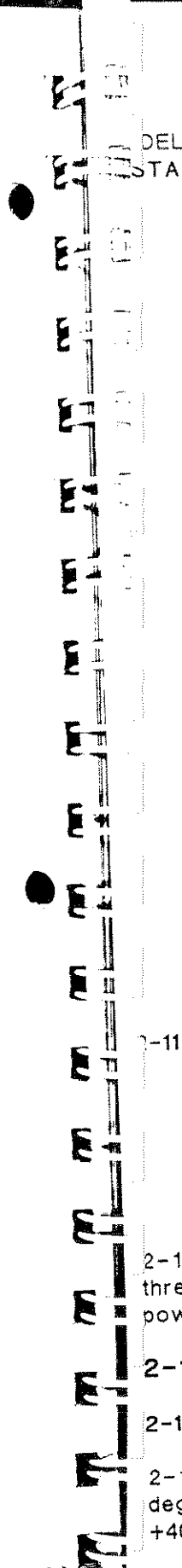

4. Temperature

15. This instrument may be operated in temperatures from 0 degrees C to +55 degrees C (+32 degrees F to +131 degrees F). Temperature range for instruments with batteries is 0 degrees C to +30 degrees C (+32 degrees F to +104 degrees F).

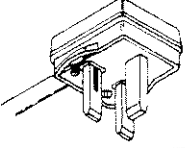
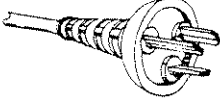
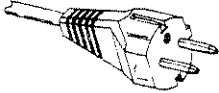
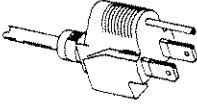
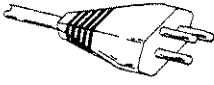

MODEL 4937A
INSTALLATION

Table 2-1. Power Cables Available

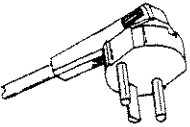
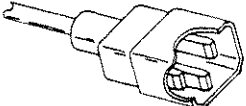
Plug Type	Cable HP Part Number	C D	Plug Description	Cable Length (inches)	Cable Color	For Use In Country
250V 	8120-1351 8120-1703	0 6	Straight *BS1363A 90°	90 90	Mint Gray Mint Gray	United Kingdom, Cyprus, Nigeria, Rhodesia, Singapore
250V 	8120-1369 8120-0696	0 4	Straight *NZSS198/ASC112 90°	79 87	Gray Gray	Australia, New Zealand
250V 	8120-1689 8120-1692	7 2	Straight *CEE7-Y11 90°	79 79	Mint Gray Mint Gray	East and West Europe, Saudi Arabia, Egypt, So. Africa, India (unpolarized in many nations)
125V 	8120-1348 8120-1398 8120-1754 8120-1378 8120-1521 8120-1676	5 5 7 1 6 2	Straight *NEMA5-15P 90° Straight *NEMA5-15P Straight *NEMA5-15P 90° Straight *NEMA5-15P	80 80 36 80 80 36	Black Black Black Jade Gray Jade Gray Jade Gray	United States, Canada, Japan (100V or 200V), Mexico, Philippines, Taiwan
250V 	8120-2104	3	Straight *SEV1011 1959-24507 Type 12	79	Gray	Switzerland
250V 	8120-0698	6	Straight *NEMA6-15P			United States Canada
220V 	8120-1957 8120-2956	2 3	Straight *DHCK 107 90°	79 79	Gray Gray	Denmark
250V 	8120-1860	6	Straight *CEE22-VI (Systems Cabinet use)			

*Part number shown for plug is industry identifier for plug only. Number shown for cable is HP Part Number for complete cable
Downloaded from www.Son Manuals.com. All Manuals Search And Download.

MODEL 4937A
OPERATION

Humidity

This instrument may be operated in environments with humidity from 5 percent to 95 percent relative humidity at +40 degrees C (+104 degrees F). However, the instrument should be protected from temperature extremes that can cause condensation within the instrument.

3. STORAGE AND SHIPMENT

Environment

The instrument may be stored and shipped within the following environmental limits:

- Temperature..... -20 to +65 degrees C (-4 to +149 degrees F)
- Humidity..... Up to 90% Relative at +65 degrees C (+149 degrees F)

1. Packaging

2. Tagging for Service.--If the instrument is being returned to Hewlett-Packard for service, please complete one of the blue repair tags located at the back of this manual and attach it to the instrument.

3. Original Packaging.--Containers and materials identical to those used in factory packaging are available through Hewlett-Packard sales and support offices. If the instrument is being returned for servicing, attach a tag indicating the type of service required, return address, model number, and full serial number. Also mark the container FRAGILE to ensure careful handling. In any correspondence, refer to the instrument by model number and full serial number.

4. Other Packaging.--The following general instructions should be used for repacking with commercially available materials:

Wrap the instrument in heavy paper or plastic. (If shipping to Hewlett-Packard office or service center, attach a tag indicating type of service required, return address, model number, and full serial number.)

Use strong shipping container. A double-walled carton made of 350-pound test material is adequate.

Use a layer of shock-absorbing material 70- to 100-mm (3- to 4-inches) thick around all sides of the instrument to provide firm cushioning and to prevent movement inside the container. Protect the control panel with cardboard.

Seal the shipping container securely.

Mark shipping container FRAGILE to ensure careful handling.

In any correspondence, refer to instrument by model number and full serial number.

MODE
INST.

2-16

2-17
relati
from

2-18

2-19

2-20

2-21

2-22
plea
instr

2-23
avai
serv
seri
refer

2-24
mer

a. V
c
n

b.
a

c. U
tl
c

d. S

e. I

f. I

SECTION III

OPERATION

3-1. INTRODUCTION

3-2. This section contains information on front and rear panel features, self check procedures, and error codes. It also describes typical operating modes. The principles of operation of the measurements are explained in Appendix A of this manual.

3-3. OPERATING CHARACTERISTICS

3-4. The HP 4937A provides two types of functions: Transmission Impairment Measurements and Supervisory Signaling.

The transmission impairment measurements that can be made with the HP 4937A are:

- Level and Frequency
- Noise
- Noise with Tone
- Signal to Noise
- Noise to Ground
- Return Loss

Signaling capabilities of the HP 4937A are:

- Supervisory signaling simulation
- Establishing talk condition for transmission testing
- Ability to hold two 2-wire circuits for testing

The types of supervisory signaling simulation are:

- Loop Start
- Ground Start
- Loop Reverse Battery
- E/M signaling Types I, II, and III
- Wink

3-5. PANEL FEATURES

3-6. Figure 3-1 identifies the front and rear panel features and includes a brief description as to the function of each feature.

7. SELF CHECK

8. The HP 4937A has two types of self checks. These are a power on self check and an extended self check. The power on self check procedure is performed automatically at power-up by the instrument. It checks most of the major circuits and should identify major problems. The error message table listed below indicates which tests are in power on self check and which are in extended self check. To perform the extended self check, externally jumper the E/M jack and the E/SB jack together, and then press the SHIFT key and the FILTER select key. Failure of the instrument to pass any self check procedure indicates a malfunction that can possibly affect other measurements.

9. ERROR MESSAGES

10. The HP 4937A gives two types of error messages. The two types of messages are either a functional error in one of the self check modes or an operational error. The errors are listed below.

11. Operational Errors:

Err 01--This error indicates that the receive level is greater than the upper limit for the selected measurement.

Err 02--Indicates that the receive level is under the lower limit for the selected measurement.

Err 07--This error signifies the loss of the 1004 Hz hold tone.

Err 09--Indicates that the level measurement currently being made needs to auto range and the Range Hold mode is set.

Err 10--Indicates that 1200 ohms impedance is selected in two wire return loss. Only 600 ohms and 900 ohms are available.

Err 30--Wink is illegal setup for Loop Start and Loop Reverse Battery Originate.

Err 31--In Loop Originate the incoming battery has negative on the tip.

12. Power On Self Check Errors:

Err 11--Indicates that the power up self test failed the ROM checksum.

Err 12--Indicates that the power up self test failed the RAM check.

Err 13--The magnitude of the cal level for the voltage to frequency converter is out of range.

Err 14--Power up self check failed to measure a frequency of 1004 Hz.

Err 15--Measurement of the hold tone frequency is not 1004 Hz.

Err 16--Power up self check failed to measure a proper level of +13.0 dBm.

Err 17--Level measured through the C-message filter is not the proper amplitude.

- Err 18--Level measured through the 3-kHz flat filter is not the proper amplitude.
- Err 19--Level measured through the 60-Hz reject filter is not the proper amplitude.
- Err 20--Level measured through the QRMS detector is not the proper amplitude.
- Err 21--Level measured through the Return Loss detector is not the proper amplitude.

3-13. Extended Self Check Errors:

- Err 50--Level of the Echo return loss waveform is not the proper amplitude.
- Err 51--Level of the Singing High return loss waveform is not the proper amplitude.
- Err 52--Level of the Singing Lo return loss waveform is not the proper amplitude.
- Err 53--The measured depth of the notch filter is too small. This test will fail if the level is too low. The transmit level must be greater than -40 dBm to pass this test.
- Err 54--The TIPPOS detector did not pass the test to detect the presence of 48 volt supply.
- Err 55--The TIPPOS detector did not pass the test to detect the absence of the 48 volt supply.
- Err 56--The TIPNEG detector did not pass the test to detect the presence of 48 volt supply.
- Err 57--The TIPNEG detector did not pass the test to detect the absence of the 48 volt supply.
- Err 58--The GNDCUR detector did not pass the test to detect the presence of current from the 48 volt supply.
- Err 59--The GNDCUR detector did not pass the test to detect the absence of current from the 48 volt supply.
- Err 60--The TERMCUR detector did not pass the test to detect the presence of current from the 48 volt supply.
- Err 61--The TERMCUR detector did not pass the test to detect the absence of current from the 48 volt supply.
- Err 62--The E lead detector did not sense the presence of the M lead. The E/M jack must be connected to the SB/SG jack to pass this test.
- Err 63--The E lead detector did not sense the absence of the M lead. The E/M jack must be connected to the SB/SG jack to pass this test.
- Err 64--The M lead detector did not sense the presence of the E lead. The E/M jack must be connected to the SB/SG jack to pass this test.
- Err 65--The M lead detector did not sense the absence of the E lead. The E/M jack must be connected to the SB/SG jack to pass this test.

4937A
OLS

The Relay Step Check is the last extended self check to be done. In this check each relay is sounded for about 100 msec, then the relay is reset. This is done for each relay in sequence at about a 2-Hz rate. If the relay is not heard on both ends of the tone it will be noticeable to the operator. Since this test relies on the operator to actually detect a missing relay closure, the test should stop on a failure. The operator must count the relays and note the number.

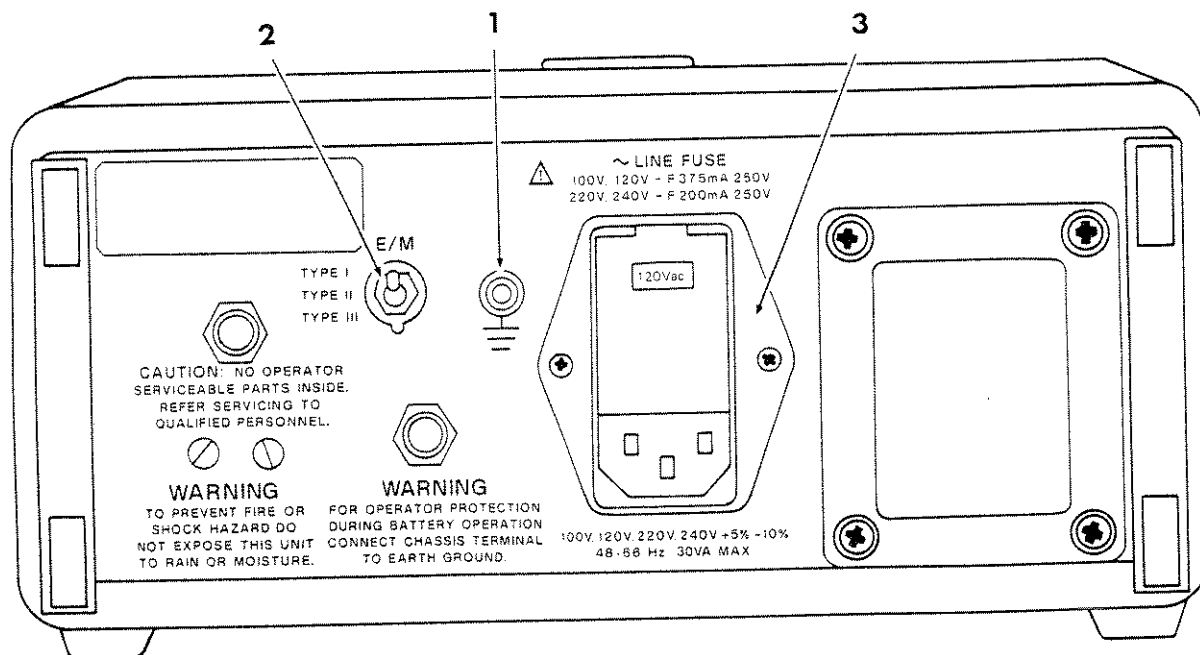
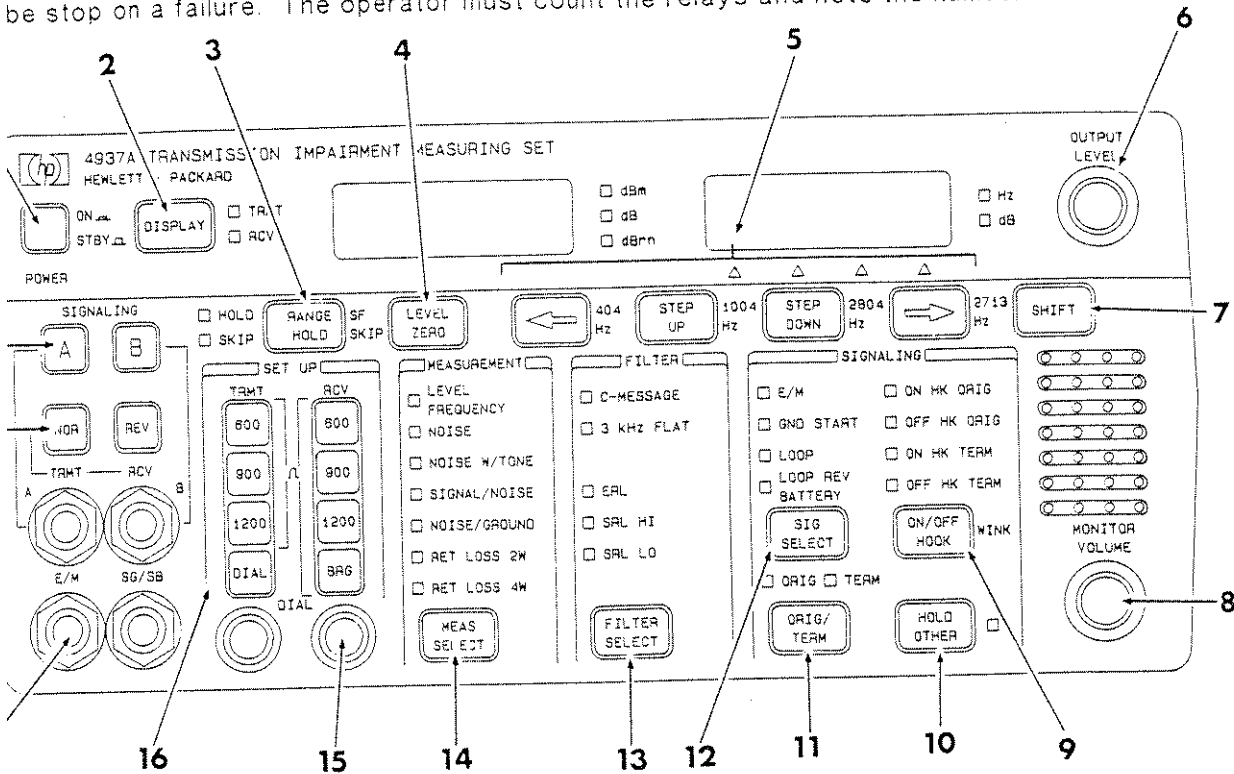

Figure 3-1. Front and Rear Panel Controls, Connectors, and Indicators.

DEL
NTRI

4. T
a to
nce
ear
not

17

3-4

3-15. CONTROLS, CONNECTORS, and INDICATORS

FRONT PANEL

1. Power Switch--Switches power to the instrument when in the ON position. In the STBY position power is still applied to some circuits. If the unit has the battery (Option 001) there will still be power available to some internal circuits even in STBY position and the batteries are charged in this position. There are separate battery operation and low battery indicators. These indicators are located in the left hand display.
2. DISPLAY key--Selects either the TRMT (transmit) or the RCV (receive) signal to be displayed. The corresponding LED will be lighted.
3. RANGE HOLD and SF SKIP key

RANGE HOLD--Prevents the autorange from changing from its present setting during a measurement.

SF Skip--Prevents the transmitter from transmitting within +/- 150 Hz (300 Hz band) of 2600 Hz. This feature eliminates accidentally being disconnected by SF signaling units on dial-up lines. Operates only in LEVEL/FREQUENCY.

4. LEVEL ZERO key--Sets a 0 dB reference in RCV LEVEL/FREQUENCY mode. All subsequent measurements will be made in dB relative to this reference. dB LED in center of the front panel will light. A - (minus) dB reading indicates levels higher than the reference level per the telephone industry convention.

In 4-wire return loss and RCV mode, the LEVEL ZERO key enters a 0 dB return loss in the left display and calculates the transhybrid loss (THL) which is displayed in the right hand display.

5. STEP UP, STEP DOWN, <- and -> keys--In TRMT Mode (right display) and LEVEL FREQUENCY; <- or -> selects the position of digit to be increased or decreased. Lighted cursor indicates one-of-four digit positions. Digit value is incremented by pressing STEP UP and decremented by pressing STEP DOWN. Pressing and holding the STEP UP or STEP DOWN key causes the action to repeat. Also, with the SHIFT key sets the output frequency to 404 Hz, 1004 Hz, 2804 Hz, and 2713 Hz in LEVEL FREQUENCY mode.

In 4-wire return loss and RCV mode, these keys are used to enter the THL of the circuit.

6. OUTPUT LEVEL Control--Adjusts the transmitter output level continuously from -40 dBm to +13 dBm. Output level is displayed on the left display.
7. SHIFT key--Used to activate any of the functions labeled in blue.
8. MONITOR VOLUME Control and Speaker--Permits adjustable volume for listening to the circuit under test or to the Test Set Transmitter.

5. CONTROLS, CONNECTORS, and INDICATORS (con't)

ON/OFF HOOK key--When the instrument is selected to be the ORIGINATE end, the ON/OFF HOOK key simulates the on-hook or off-hook condition of the originate end. When the instrument is the TERMINATE end the ON/OFF HOOK key simulates the on-hook or off-hook condition of the terminate end.

STATUS LEDs--There are four status LEDs that indicate the status of both the originate and terminating ends of the line. The status lights are:

ON HK ORIG (on-hook originate)

OFF HK ORIG (off-hook originate)

ON HK TERM (on-hook terminate)

OFF HK TERM (off-hook terminate)

3. HOLD OTHER--Puts an auxillary hold circuit on the B jack if the A signaling key is pressed. The auxillary hold circuit will be placed on the A jack if the B signaling key is pressed. (used to seize a second 2-wire circuit for testing)

1. ORIG/TERM key--Selects whether the type of signaling is originate or terminate.

2. SIG SELECT key--Selects one of the following signaling modes. Lighted LED indicates selected signaling.

E/M (E and M)

GND START (ground start)

LOOP (loop start)

LOOP REV BATTERY (loop reverse battery)

3. FILTER SELECT key--Selects desired weighting filter for noise measurements and the type of spectrum for return loss measurement.

4. MEAS SELECT key--Selects one of the following measurements. Lighted LED indicates selected measurement.

LEVEL FREQUENCY

NOISE

NOISE W/TONE (noise with tone)

SIGNAL/NOISE (signal to noise)

NOISE TO GROUND

RET LOSS 2W (return loss 2 wire)

RET LOSS 4W (return loss 4 wire)

3-15. CONTROLS, CONNECTORS, and INDICATORS (con't)

15. DIAL binding posts--A handset can be connected to the binding posts to dial-up a line.

16. SET UP switches

TRMT

600, 900, 1200 ohms--Provides terminating impedance to match the characteristic impedance of the line.

150, 600, 1200 ohms (Option 002)--Provides terminating impedance to match the characteristic impedance of the line.

DIAL--Connects the dial jack to the line that is connected to the A or B jack. This inturn connects the DIAL jack to signaling module. The dial jack is routed to the appropriate place determined by the signaling mode.

RCV

600, 900, 1200 ohms--Provides terminating impedance to match the characteristic impedance of the line.

150, 600, 1200 ohms (Option 002)--Provides terminating impedance to match the characteristic impedance of the line.

BRG--Sets the receiver to a high impedance when the HP 4937A is bridging the circuit under test instead of terminating the line.

17. E/M and SB/SG Jacks--These jacks are used for E/M type signaling. For the three different types of E/M signaling (Type I, II, & III) the appropriate connections are made to the two jacks. Selection of the three types of E/M signaling is made using a switch on the rear panel.

18. NOR and REV switches--The NOR switch connects the A 310 jack to the transmitter and the B 310 jack to the receiver. The REV switch connects the A 310 jack to the receiver and the B 310 jack to the transmitter. When the NOR and REV switches are either both out or both pressed in, the transmitter and receiver are internally looped.

19. A and B SIGNALING switches--The A switch connects the A 310 jack to the loop signaling module and an auxillary hold circuit is available on the B 310 jack. The B switch connects the B 310 jack to the loop signaling module and moves the auxillary hold circuit to the A jack.

REAR PANEL

1. GROUND Jack--Used to connect the HP 4937A to earth ground.

2. E/M SELECTION Switch--Used to select one of the three types of E/M signaling. An audible beep denotes which type of signaling was selected with a corresponding 1, 2, or 3 beeps.

3. Voltage Select--Allows selection of proper line voltage.

6. OPERATING INSTRUCTIONS

POWER ON AND SET UP

Ac Power On

Connect power cord to the rear line module on which the correct line voltage has been selected. See Section II for procedure to select line voltage.

WARNING

Always connect power cord to a properly grounded 3-wire power outlet. Any interruption of the protective earth grounding will cause a potential shock hazard that could result in personal injury.

Press POWER ON pushbutton. The HP 4937A will automatically do a self check.

Battery Power On (Option 001 only)

WARNING

For operator protection during battery operation, connect the chassis termination on the rear panel to earth ground.

Disconnect power cord.

Press POWER ON pushbutton. When switching between battery and ac power, cycle the POWER pushbutton from ON to STBY to ON.

Set Up

CAUTION

Do not connect more than 200 Vdc or 10V rms at 60 Hz to the 310 jacks.

Connect circuit under test to the 310 jacks.

Press the NOR pushbutton to connect the left 310 jack to the transmitter and the right 310 jack to the receiver.

To reverse the direction of the test press the REV pushbutton.

Press the SET UP TRMT pushbutton that corresponds to the circuit impedances on the transmitter side (150, 600, 900, or 1200).

Press the SET UP RCV pushbutton that corresponds to the circuit impedance on the receiver side (150, 600, 900, or 1200).

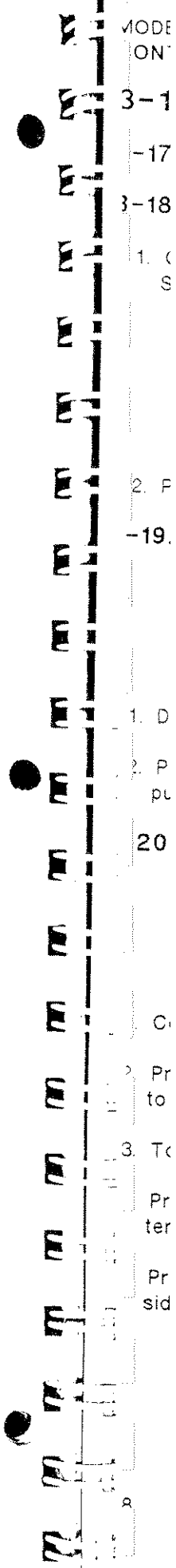

3-21. SIGNALING

3-22. This section describes the signaling function of the HP 4937A and gives detailed procedures for seizing the line for testing. The HP 4937A measuring circuits are disconnected from the line under test until both ends of the line have been seized.

3-23. Signaling notifies the switch (central office, PBX, etc.) that a subscriber desires service. Signaling also is used to notify the subscriber of incoming calls. Then, with the necessary data to identify the distant subscriber, the switch will properly route the call.

3-24. The terms on-hook (open switch) and off-hook (closed switch) are used throughout this section to describe the state of signaling equipment regardless of the actual type of signaling used. To identify the circuits, the terms originate equipment and terminate equipment are used. These terms refer only to the hardware configuration and not with the action of initiating the call. The terminate equipment supplies the operating power and current detect circuitry. The originate equipment provides a dc current path via a switch.

3-25. Supervisory signaling deals with the circuits that monitor the status of a subscriber loop or a trunk line. The four types of supervisory signaling that are commonly used are: loop start, ground start, loop reverse battery, and E/M.

3-26. The signaling procedures that follow are arranged in a manner to configure the HP 4937A first as the Originate End equipment, and then as the Terminate End equipment. Procedures to establish talk conditions using the HP 4937A are also included.

3-27. LOOP START SIGNALING

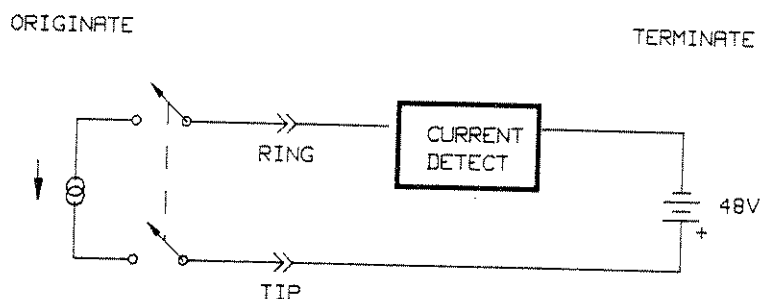
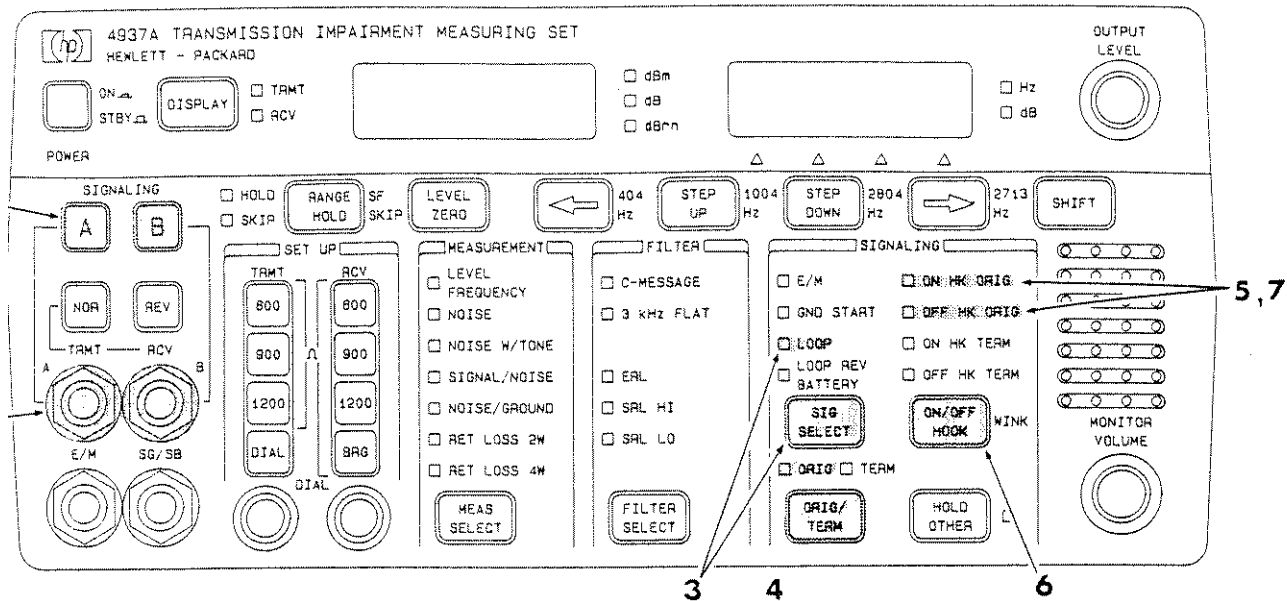

Figure 3-2. Loop Start Signaling

3-28. Loop start signaling is used with the circuits that monitor the status of a subscriber loop (see figure 3-2). The signaling starts with the line in an idle state. When the telephone is off-hook the central office detects the current flow and responds with a dial tone. The dial tone is the central office's off-hook state. The HP 4937A can be either the originate end (telephone) or the terminate end (central office).



ng The Line--Loop Start Originate End

onfigure the HP 4937A as the Originate End proceed as follows:

onnnect the line under test to either 310-jack A or B.

select SIGNALING A if the line under test is connected to 310-jack A or SIGNALING B if the line is
nnected to 310-jack B.

sing SIG SELECT key select Loop Start signaling mode. The LOOP LED should be lighted.

sing ORIG/TERM key select ORIG. The ORIG LED should be lighted.

erify the following LEDs:

- ▶ ON HK ORIG - lighted
- ▶ OFF HK ORIG - off

o seize the line under test press ON/OFF HOOK key.

erify the following LEDs:

- ▶ ON HK ORIG - off
- ▶ OFF HK ORIG - lighted

he line under test is seized. You can now proceed to one of the following:

- ▶ Establish talk condition
- ▶ Conduct transmission impairment measurements
- ▶ Release the line

Establishing Talk Condition

1. Seize the line as described in the previous section, Loop start Originate End.
2. Connect lineman's handset (butt-in) to DIAL jacks located on the front panel.
3. Press DIAL key. OFF HK ORIG LED should be lighted and a tone should be heard on the handset.
4. The line is now ready to accept dial pulses, tones, or voice.
5. To perform transmission impairment measurements, release DIAL key (an internal hold coil will continue to hold the line).
6. Perform desired measurement as described in the Measurements Section.

Releasing The Line

1. Press ON/OFF HOOK key and verify the following LEDS:
 - ON HK ORIG - lighted
 - OFF HK ORIG - off
2. Pressing the ON/OFF HOOK key again will re-seize the line.

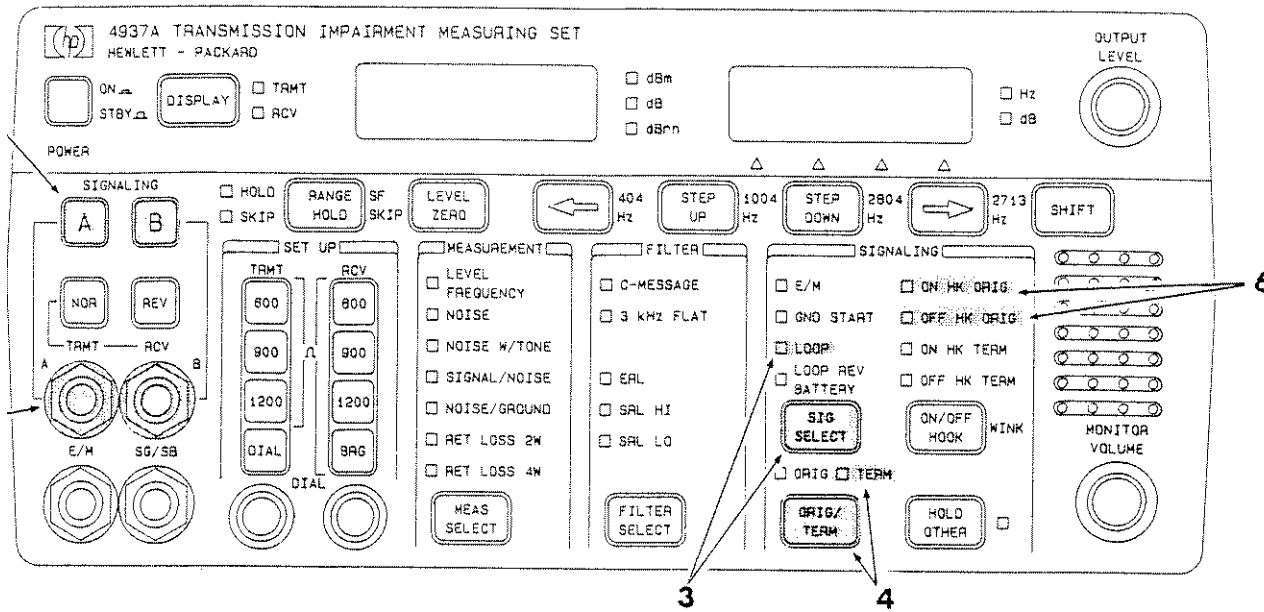

ing The Line--Loop Start Terminate End

onfigure the HP 4937A as the Terminate End proceed as follows:

onnnect the line under test to either 310-jack A or B.

select SIGNALING A if the line under test is connected to 310-jack A or SIGNALING B if the line is nnnected to 310-jack B.

sing SIG SELECT key select Loop Start signaling mode. The LOOP LED should be lighted.

sing ORIG/TERM key select TERM. The TERM LED should be lighted.

ffice battery is now provided on the line.

he status LEDs indicate the condition of the far end (originate) of the line. When the originate end es off-hook, then verify the following LEDs:

- ON HK ORIG - off
- OFF HK ORIG - lighted

he line under test is seized. You can now proceed to one of the following:

- Establish talk condition
- Conduct transmission impairment measurements
- Release the line

Establishing Talk Condition

1. Seize the line as described in the previous section, Loop Start Terminate End.
2. Connect lineman's handset (butt-in) to DIAL jacks located on the front panel.
3. Press DIAL key. The HP 4937A will provide talk battery and will ac couple lineman's handset to the line under test.
4. The line is now ready to accept tones or voice.
5. To perform transmission impairment measurements, release the DIAL key.
6. Perform desired measurement as described in the Measurements Section.

Releasing The Line

1. Loop start terminate always provides office battery. To remove battery, use SIG SELECT key to turn off signaling.

GROUND START SIGNALING

Ground start signaling is commonly used on trunk lines between a PBX and a central office. The PBX is usually the originate end and the central office is the terminate end. Either end can seize the trunk by providing a current path to ground. When both ends are off-hook, the line looks very similar to Loop Start signaling.

The HP 4937A can function as either the originate end (PBX) or the terminate end (central office). As the originate end, the HP 4937A begins the loop closure by grounding the ring (goes off hook closing S-1) which causes a current to flow through the line (see figure 3-3).

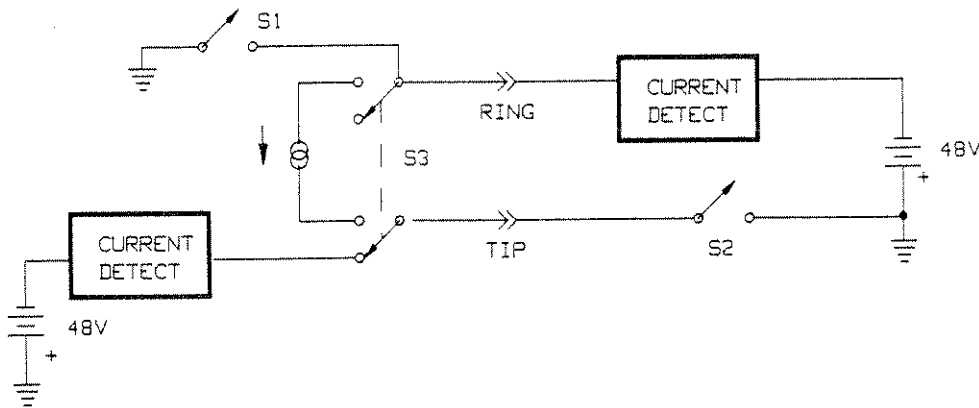
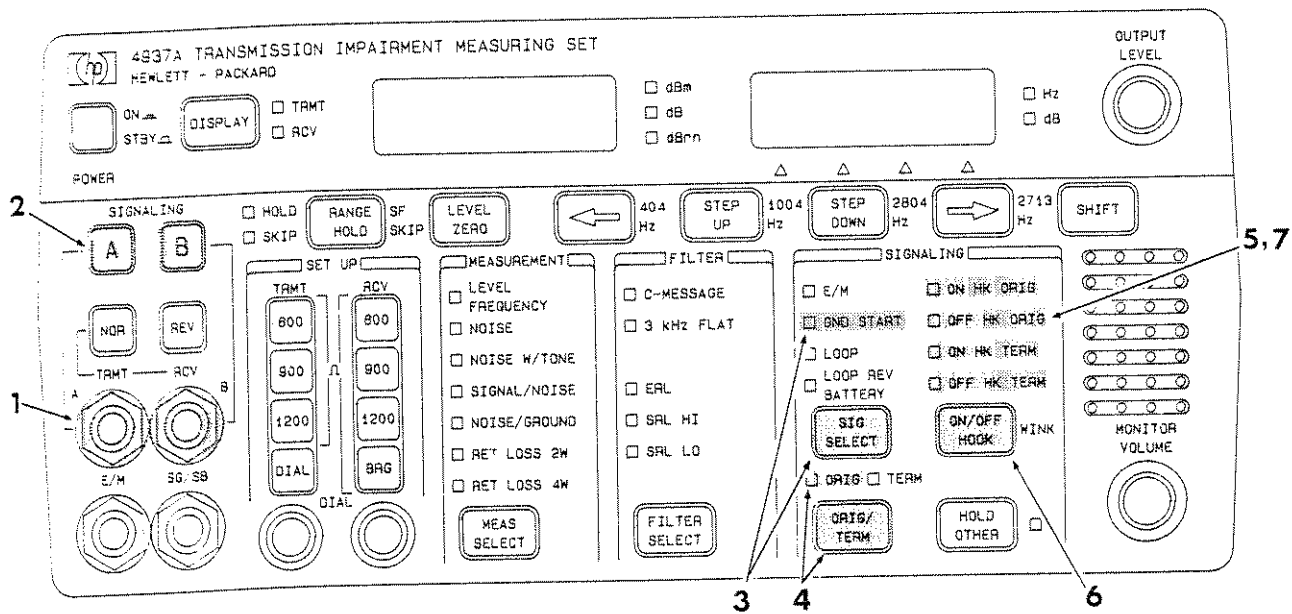

Figure 3-3. Ground Start Signaling Circuit

The terminate equipment senses this current flow and interprets it as a request for the trunk. The terminate equipment acknowledges the request by grounding the tip (goes off hook closing S-2) of the line. This causes a current to flow through the tip side of the line from the originate end to the terminate end.

The HP 4937A will recognize the current through the tip side of the circuit and will: remove the ground from the ring (opening S-1), remove the 48 volts from the tip, and at the same time place a coil (current sink) between tip and ring (closing S-3) causing the current to flow from the terminate equipment to the HP 4937A and back to the terminate equipment. The loop is now closed (S-1 and S-2 are open) and the terminate equipment responds with a dial tone.

MODEL 4937A
GROUND START



Seizing The Line--Ground Start Originate End

To configure the HP 4937A as the Originate End proceed as follows:

1. Connect the line under test to either 310-jack A or B.
2. Select SIGNALING A if the line under test is connected to 310-jack A or SIGNALING B if the line is connected to 310-jack B.
3. Using SIG SELECT key select Ground Start signaling mode. The GND START LED should be lighted.
4. Using ORIG/TERM key select ORIG. The ORIG LED should be lighted.
5. Verify the following LEDs :
 - ON HK ORIG - lighted
 - OFF HK ORIG - off
 - ON HK TERM - lighted
 - OFF HK TERM - off
6. To seize the line under test press ON/OFF HOOK key.
7. The line under test is seized when the LEDs indicate the following:
 - ON HK ORIG - off
 - OFF HK ORIG - lighted
 - ON HK TERM - off
 - OFF HK TERM - lighted

4937A
ID START

can now proceed to perform one of the following:

- Establish talk conditions
- Conduct transmission impairment measurements
- Release the line

Establishing Talk Condition

Seize the line as described in the previous section, Ground Start Originate End.

Connect lineman's handset (butt-in) to DIAL jacks located on the front panel.

Press DIAL key. OFF HK ORIG LED should be lighted and a tone should be heard in the handset.

When the terminate end responds by going off-hook, the line is ready to accept dial pulses, tones, or voice.

To perform transmission impairment measurements, release DIAL key (an internal hold coil will continue to hold the line).

Perform desired measurement as described in the Measurements Section.

Releasing The Line

Press ON/OFF HOOK key and verify the following LEDs:

- ON HK ORIG - lighted
- OFF HK ORIG - off

Pressing the ON/OFF HOOK key again will re-seize the line.

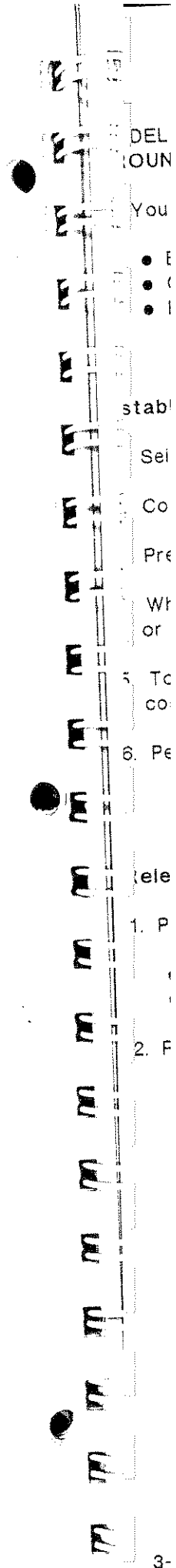

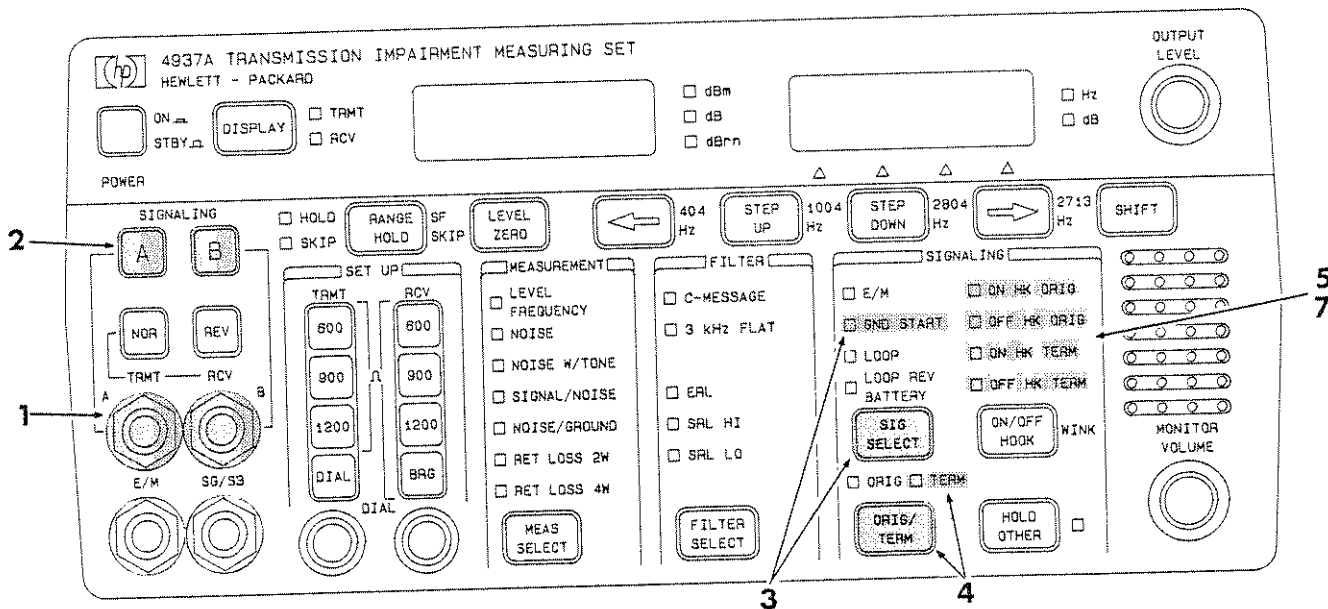

Seizing The Line--Ground Start Terminate End

To configure the HP 4937A as the Terminate End proceed as follows:

1. Connect the line under test to either 310-jack A or B.
2. Select SIGNALING A if the line under test is connected to 310-jack A or SIGNALING B if the line is connected to 310-jack B.
3. Using SIG SELECT key select Ground Start signaling mode. The GND START LED should be lighted.
4. Using ORIG/TERM key select TERM. The TERM LED should be lighted.
5. Verify the following LEDs :
 - ON HK ORIG - lighted
 - OFF HK ORIG - off
 - ON HK TERM - lighted
 - OFF HK TERM - off
6. To seize the line under test press ON/OFF HOOK key.
7. The line under test is seized when the LEDs indicate the following:
 - ON HK ORIG - off
 - OFF HK ORIG - lighted
 - ON HK TERM - off
 - OFF HK TERM - lighted

3-34. LOOP REVERSE BATTERY SIGNALING

3-35. Loop reverse battery is used to signal one way trunks. This is most often used in PBXs for direct inward dial (DID) lines. Direct inward dialing permits an outside call to be dialed directly to a PBX subscriber loop without operator assistance. The on-hook and off-hook states at the terminate end are indicated by reversing the battery polarity (see figure 3-4).

3-36. The term one-way trunk refers to only the signaling characteristics of the trunk and not to the direction of communications. The call can be initiated by only the originate end of the trunk. Once the signaling is complete, the trunk will carry normal two-way communications. The HP 4937A can be used as either the originate end (outside call) or the terminate end (PBX).

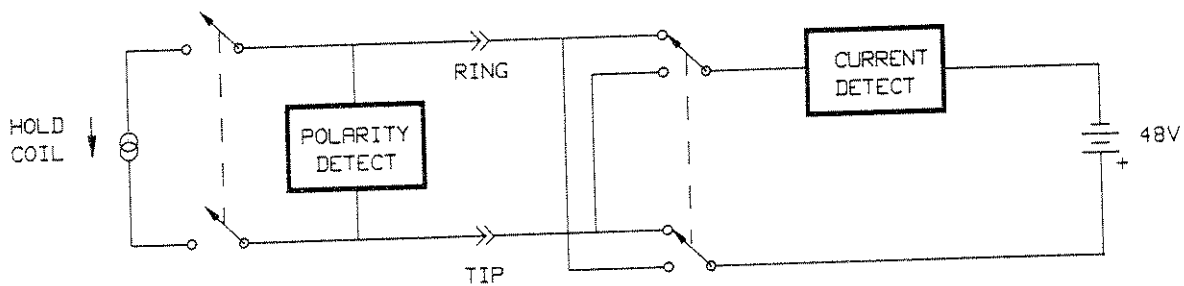
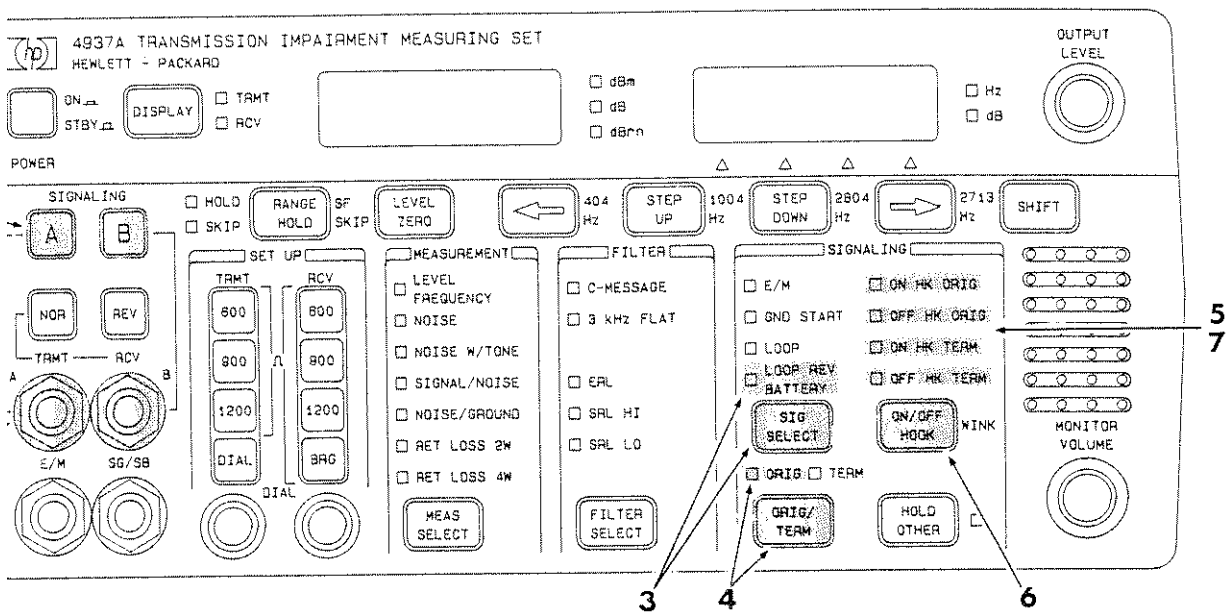

Figure 3-4. Loop Reverse Battery Signaling

4937A
REVERSE BATT



3 The Line--Loop Reverse Battery Originate End

figure the HP 4937A as the Originate End proceed as follows:

nect the line under test to either 310-jack A or B.

ct SIGNALING A if the line under test is connected to 310-jack A or SIGNALING B if the line is
ected to 310-jack B.

ig SIG SELECT key select Loop Reverse Battery signaling mode. The LOOP REV BATTERY
should be lighted.

ig ORIG/TERM key select ORIG. The ORIG LED should be lighted.

ify the following LEDs:

- ON HK ORIG - lighted
- OFF HK ORIG - off
- ON HK TERM - lighted
- OFF HK TERM - off

seize the line under test press ON/OFF HOOK key.

line under test is seized when the LEDs indicate the following:

- ON HK ORIG - off
- OFF HK ORIG - lighted
- ON HK TERM - off
- OFF HK TERM - lighted

8. You can now proceed to perform one of the following:

- Establish talk conditions
- Conduct transmission impairment measurements
- Release the line

Establishing Talk Condition

1. Seize the line as described in the previous section, Loop Reverse Battery Originate End.
2. Connect lineman's handset (butt-in) to DIAL jacks located on the front panel.

Note

A tone will be heard immediately, but the handset is not actually connected to the line until after the DIAL key is pressed.

3. Press DIAL key. OFF HK ORIG LED should be lighted and a tone should be heard on the handset.
4. The line is now ready to accept dial pulses, tones, or voice.
5. To perform transmission impairment measurements, release DIAL key (an internal hold coil will continue to hold the line).
6. Perform desired measurement as described in the Measurements Section.

Releasing The Line

1. Press ON/OFF HOOK key and verify the following LEDS:
 - ON HK ORIG - lighted
 - OFF HK ORIG - off
2. Pressing the ON/OFF HOOK key again will re-seize the line.

4937A
REVERSE BATT

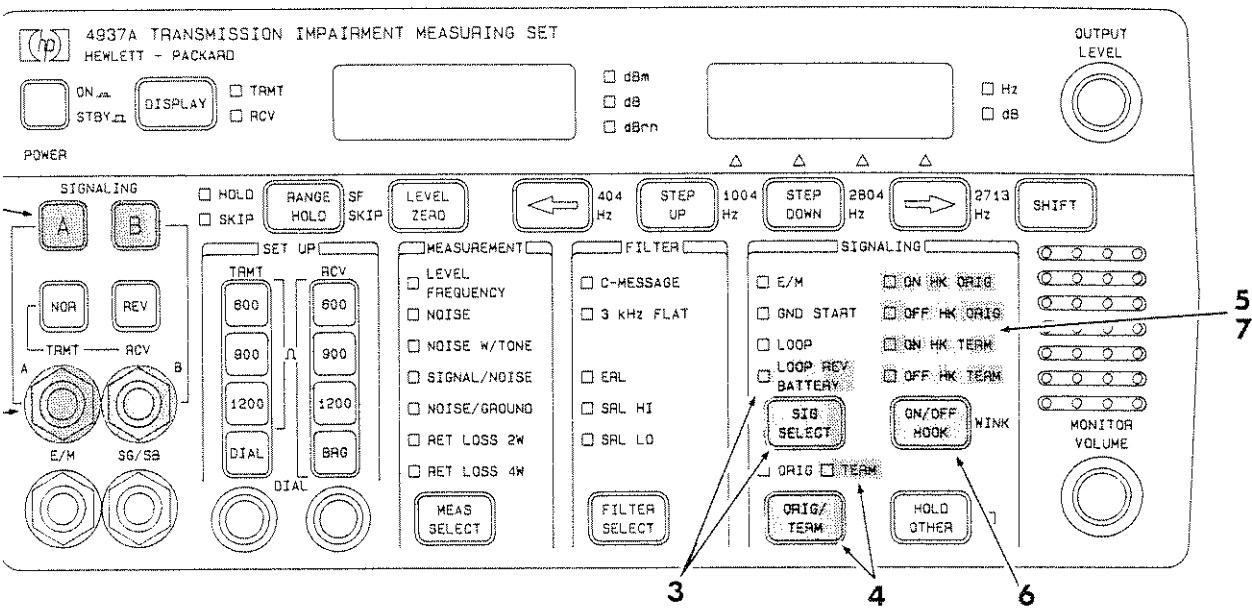

ing The Line--Loop Reverse Battery Terminate End

Configure the HP 4937A as the Terminate End proceed as follows:

Connect the line under test to either 310-jack A or B.

Select SIGNALING A if the line under test is connected to 310-jack A or SIGNALING B if the line is connected to 310-jack B.

Pressing SIG SELECT key select Loop Reverse Battery signaling mode. The LOOP REV BATTERY LED should be lighted.

Pressing ORIG/TERM key select TERM. The TERM LED should be lighted.

Verify the following LEDs :

- ON HK ORIG - lighted
- OFF HK ORIG - off
- ON HK TERM - lighted
- OFF HK TERM - off

To seize the line under test press ON/OFF HOOK key. (Technically, the terminate end of Loop Reverse Battery cannot seize the line, it can only respond to a request for seizure from the originate end.)

The line under test is seized when the LEDs indicate the following:

- ON HK ORIG - off
- OFF HK ORIG - lighted
- ON HK TERM - off
- OFF HK TERM - lighted

8. You can now proceed to perform one of the following:
 - Establish talk conditions
 - Conduct transmission impairment measurements
 - Release the line

Establishing Talk Condition

1. Seize the line as described in the previous section, Loop Reverse Battery Terminate End.
2. Connect lineman's handset (butt-in) to DIAL jacks located on the front panel.
3. Press DIAL key. The HP 4937A will provide talk battery and will ac couple lineman's handset to the line under test.
4. The line is now ready to accept tones or voice.
5. To perform transmission impairment measurements, release DIAL key.
6. Perform desired measurement as described in the Measurements Section.

Releasing The Line

1. Press ON/OFF HOOK key and verify the following LEDS:
 - ON HK TERM - lighted
 - OFF HK TERM - off
2. Pressing the ON/OFF HOOK key again will re-seize the line.

E/M SIGNALING

E/M signaling is used primarily to signal the internal switching of the PBX or shorthaul trunks between two PBXs. E/M signaling uses a separate wire pair to send signaling information (E lead and M) from the pair used to send voiceband information (tip and ring). In addition, E/M Types II and III use a sense ground (SG) and sense battery (SB) leads to improve signaling performance. (see Figures 3-5, 3-6, and 3-7)

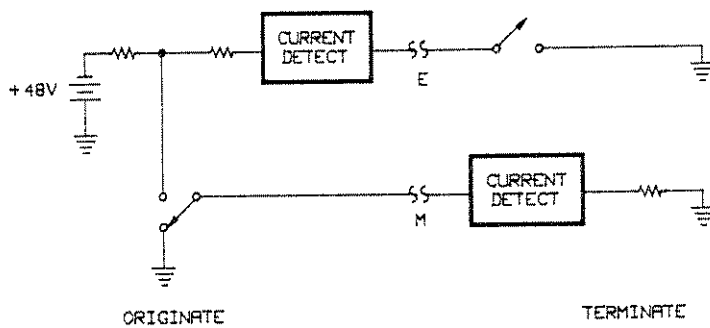

Figure 3-5. E/M Type I Signaling

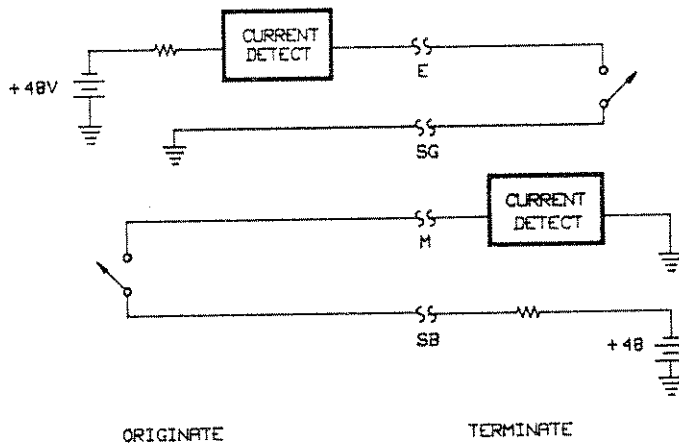

Figure 3-6. E/M Type II Signaling

ODE
/M
-37
-38
etwe
leac
use
gure

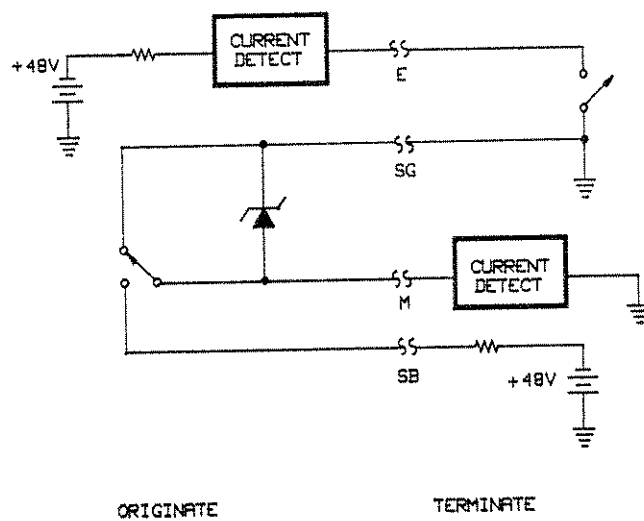
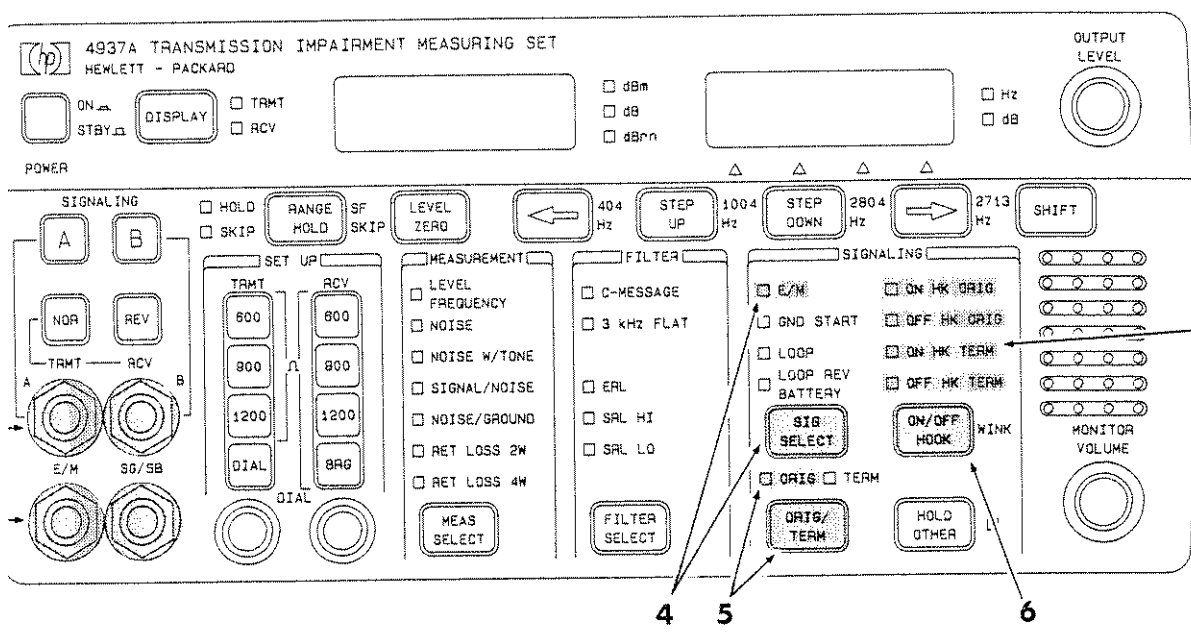

Figure 3-7. E/M Type III Signaling



ing The Line--E/M Signaling Types I, II, and III Originate End

figure the HP 4937A as the Originate End, proceed as follows:

nect the line (or lines if 4-wire) under test to 310-jack A or B.

nect E/M leads (for E/M Types II and III connect SG/SB leads also).

t E/M toggle switch (located on rear panel) to desired signal type. E/M type must be selected ore E/M is selected on front panel.

ing SIG SELECT key select E/M signaling mode. The HP 4937A will beep one, two, or three es to indicate the type E/M selected. The E/M LED should be lighted.

ing ORIG/TERM key select ORIG. The ORIG LED should be lighted.

o seize the line under test press ON/OFF HOOK key.

ie line is seized when the LEDs indicate the following:

- ON HK ORIG - off
- OFF HK ORIG - lighted
- ON HK TERM - off
- OFF HK TERM - lighted

ou can now proceed to perform one of the following:

- Establish talk conditions
- Conduct transmission impairment measurements
- Release the line

seizure

o co

Co

Co

Se

bef

Us

tim

Us

Tc

Th

•

•

•

Yc

•

•

•

Establishing Talk Condition

1. Seize the line as described in the previous section, E/M Signaling Types I, II, and III Originate End.
2. Connect lineman's handset (butt-in) to DIAL jacks located on the front panel.
3. Select SIGNALING A if the line under test is connected to 310 jack A or to SIGNALING B if connected to 310 jack B.
4. Press DIAL key. The HP 4937A will provide talk battery to the linemen's handset. Tones and voice will be coupled to the line under test. Dial pulses will be connected to the M lead.
5. The line is now ready to accept dial pulses, tones, or voice.
6. To perform transmission impairment measurements, release DIAL key.
7. Perform desired measurement as described in the Measurements Section.

Releasing The Line

1. Press ON/OFF HOOK key and verify the following LEDs:
 - ON HK TERM - lighted
 - OFF HK TERM - off
2. Pressing the ON/OFF HOOK key again will re-seize the line.

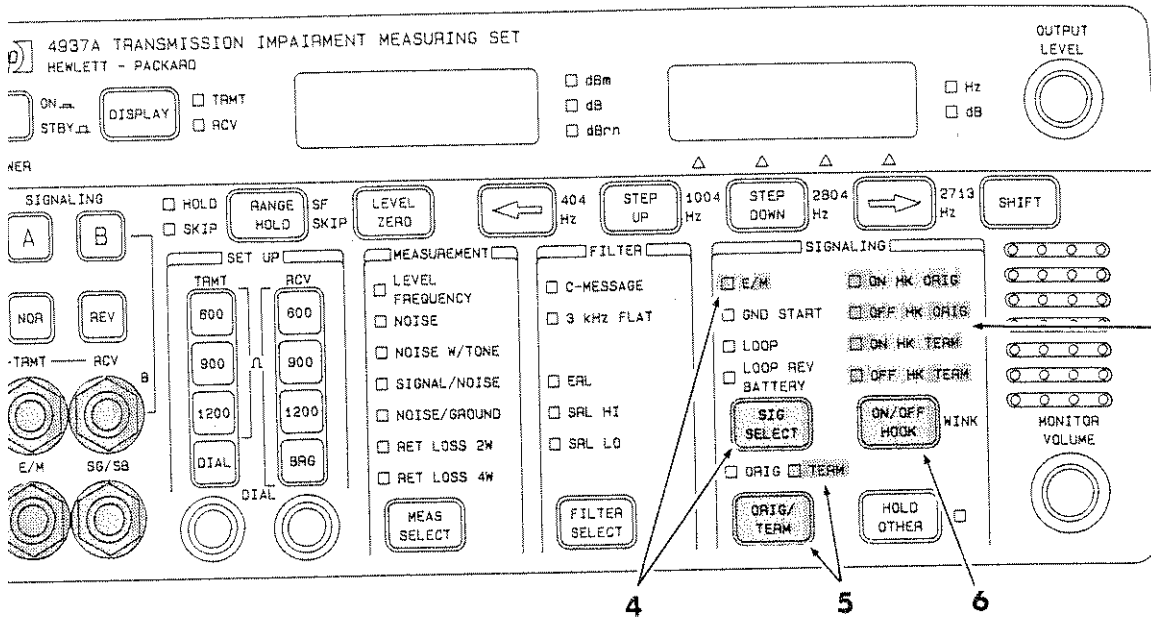

The Line--E/M Signaling Types I, II, and III Terminate End
 Figure the HP 4937A as the Terminate End, proceed as follows:

1. Connect the line (or lines if 4-wire) under test to 310-jack A or B.
 2. Connect E/M leads (for E/M Types II and III connect SG/SB leads also).

3. Set E/M toggle switch (located on rear panel) to desired signal type. E/M type must be selected
 4. Make sure E/M is selected on front panel.

5. Press SIG SELECT key select E/M signaling mode. The HP 4937A will beep one, two, or three
 times to indicate the type E/M selected. The E/M LED should be lighted.

6. Press ORIG/TERM key select TERM. The TERM LED should be lighted.

7. To seize the line under test press ON/OFF HOOK key.

8. The line is seized when the LEDs indicate the following:

- ON HK ORIG - lighted
- OFF HK ORIG - off
- ON HK TERM - lighted
- OFF HK TERM - off

9. You can now proceed to perform one of the following:

- Establish talk conditions
- Conduct transmission impairment measurements
- Release the line

Establishing Talk Condition

1. Seize the line as described in the previous section, E/M Signaling Types I, II, and III Terminate End.
2. Connect lineman's handset (butt-in) to DIAL jacks located on the front panel.
3. Select SIGNALING A if the line under test is connected to 310 jack A or to SIGNALING B if connected to 310 jack B.
4. Press DIAL key. The HP 4937A will provide talk battery to the linemen's handset. Tones and voice will be coupled to the line under test. Dial pulses will be connected to the E lead.
5. The line is now ready to accept dial pulses, tones, or voice.
6. To perform transmission impairment measurements, release DIAL key.
7. Perform desired measurement as described in the Measurements Section.

Releasing The Line

1. Press ON/OFF HOOK key and verify the following LEDS:
 - ON HK TERM - lighted
 - OFF HK TERM - off
2. Pressing the ON/OFF HOOK key again will re-seize the line.

WINK

Wink is a signaling technique used to pass address information down a trunk line. It is a binary on-hook to off-hook to on-hook transition that signals the far end to begin sending address digits (see figure 3-8).

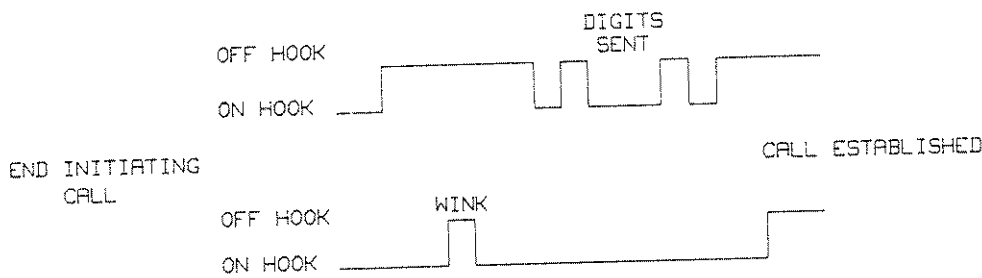

Figure 3-8. Wink Signaling Technique

The initiating end begins the process by going off-hook. The receiving end when ready, responds with a wink. The initiating end then sends the digits to the receiving end. Once the receiving end has received all the digits and completes the connection, it ends the sequence by going off-hook.

The HP 4937A is capable of providing Wink for E/M, Ground Start, and Loop Reverse Battery mode. The Wink times are specified in figure 3-9. The address digits sent to the HP 4937A are ignored and cannot be displayed.

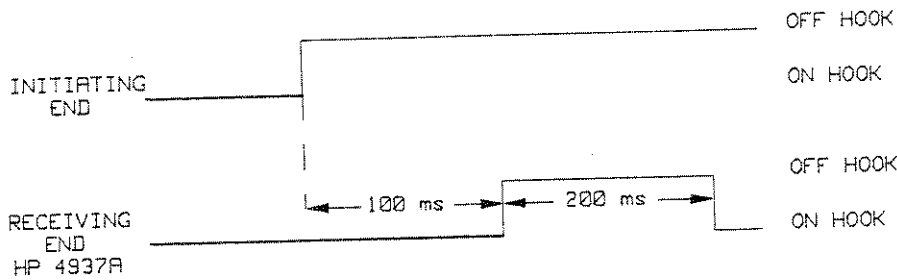
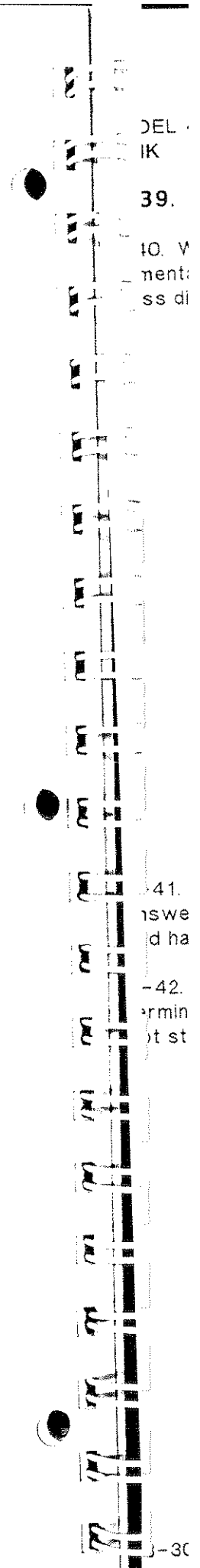
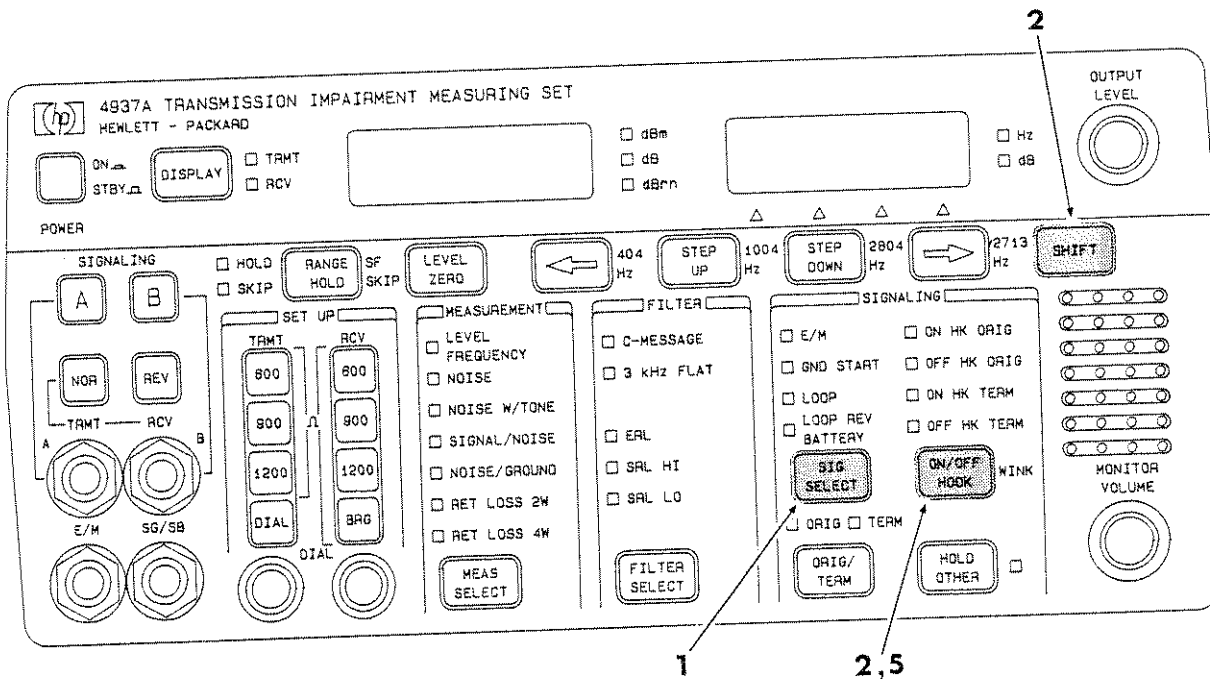

Figure 3-9. Wink Times





Using Wink Signaling

1. Configure the HP 4937A to the signaling mode desired.
2. Press the SHIFT key followed by the ON/OFF HOOK key.

Note

Err 30 will be displayed if wink is used with an illegal signaling mode or if both ends of the line are not in the off-hook state.

3. The appropriate status LED will blink rapidly. This indicates the wink is armed and in a ready state. Wink can be disarmed by pressing any key.
4. When the far end goes off-hook, the HP 4937A will respond with rapid off-hook and on-hook transitions.
5. After the digits have been received, place the HP 4937A in the off-hook state by pressing the ON/OFF HOOK key.
6. The line is now seized and you can proceed to perform one of the following:
 - Establish talk condition
 - Conduct transmission impairment measurements
 - Release the line

Establishing Talk Condition

Seize the line as described in the previous section, Using Wink Signaling.

Connect lineman's handset (butt-in) to DIAL jacks located on the front panel.

Press DIAL key. OFF HK ORIG LED should be lighted and a tone should be heard on the handset.

The line is now ready to accept dial pulses, tones, or voice.

When perform transmission impairment measurements, release DIAL key (an internal hold coil will continue to hold the line).

Perform desired measurement as described in the Measurements Section.

Releasing The Line

Press ON/OFF HOOK key and verify the following LEDS:

- ON HK ORIG - lighted
- OFF HK ORIG - off

Pressing the ON/OFF HOOK key again will re-seize the line.

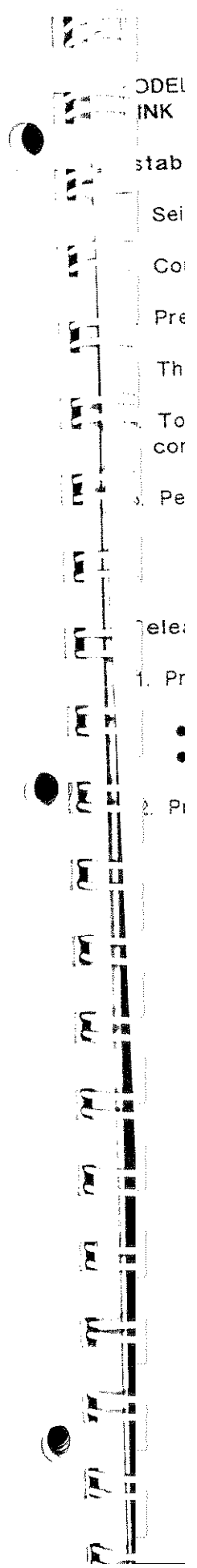

3-43. MEASUREMENTS

3-44. Level and Frequency

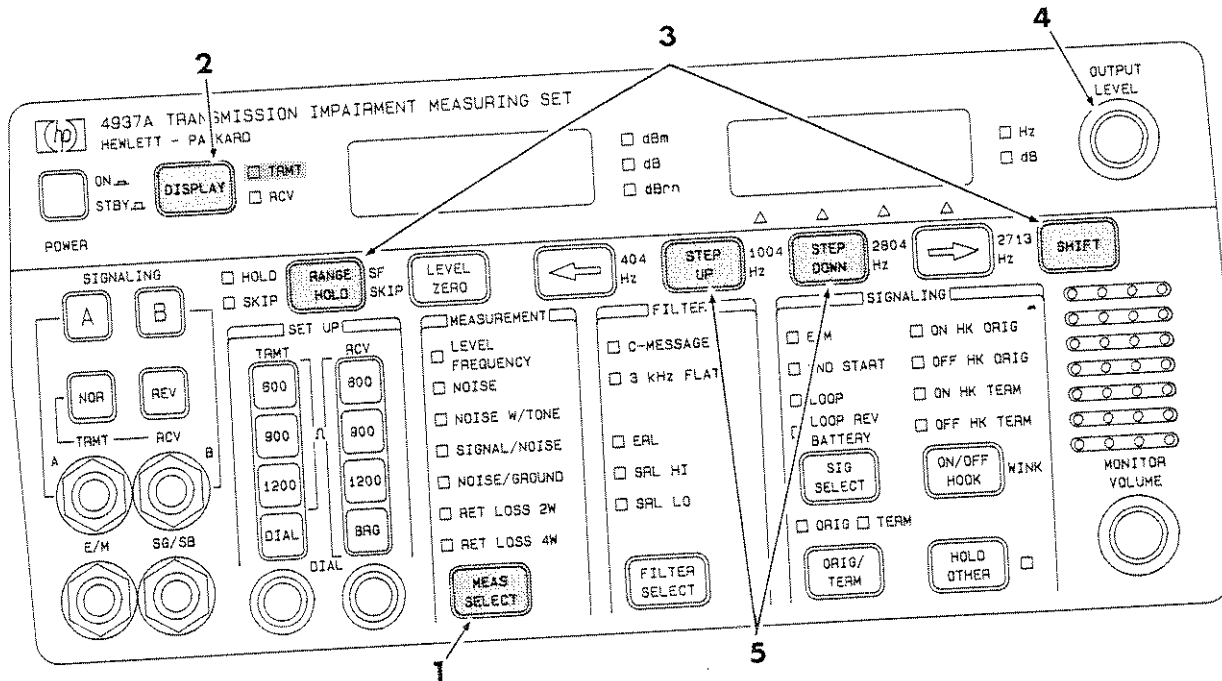

TRANSMITTER

1. Using the MEAS SELECT key select LEVEL FREQUENCY.

2. Press DISPLAY-TRMT key to display the transmitted signal. TRMT indicator will light. Level can be read in the left display and frequency can be read in the right display.

3. If SF signaling units are used on the circuit under test, press SHIFT key, then RANGE HOLD key to select SF SKIP which blanks the frequency from 2450 Hz to 2750 Hz.

4. Turn OUTPUT LEVEL knob to adjust the level of the transmitted signal to data level, which is usually 13 dB below the transmitted level point (TLP). An Err 01 displayed indicates the level is >+16 dBm. An Err 02 displayed indicates the level is <-70 dBm.

5. Use the STEP UP and STEP DOWN keys to select the desired output frequency. To select one of the preset frequencies (404 Hz, 1004 Hz, 2804 Hz, or 2713 Hz) press the SHIFT key and then press the desired frequency key.

Level and Frequency (con't)

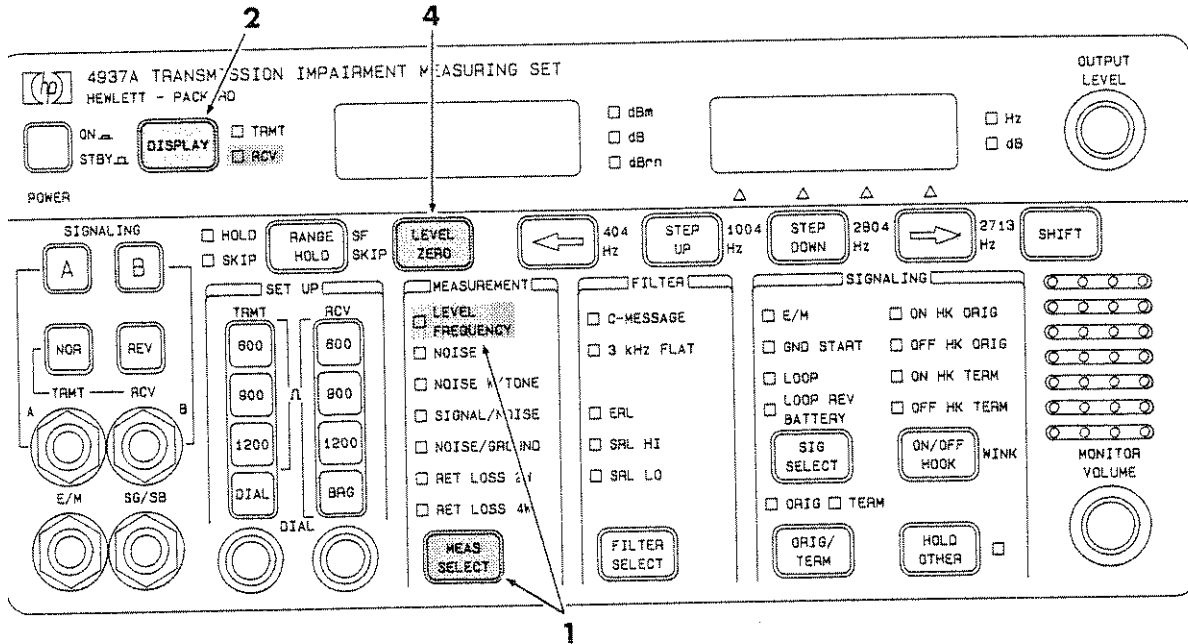

OPERATION

Pressing the MEAS SELECT key select LEVEL FREQUENCY.

Press DISPLAY-RCV key to display the received signal. RCV indicator will light. Level can be read on the left display.

Err 01 displayed indicates the signal is >+16 dBm. An Err 02 displayed indicates the signal is <-70 dBm.

For attenuation distortion measurements press LEVEL ZERO key to set the received level at 0 dB. For subsequent level measurements will be made relative to this point. Pressing the LEVEL ZERO key a second time reverts the level to absolute units (dBm) instead of relative units (dB). A negative reading indicates levels higher than the reference level per the telephone industry convention.

3-45. NOISE

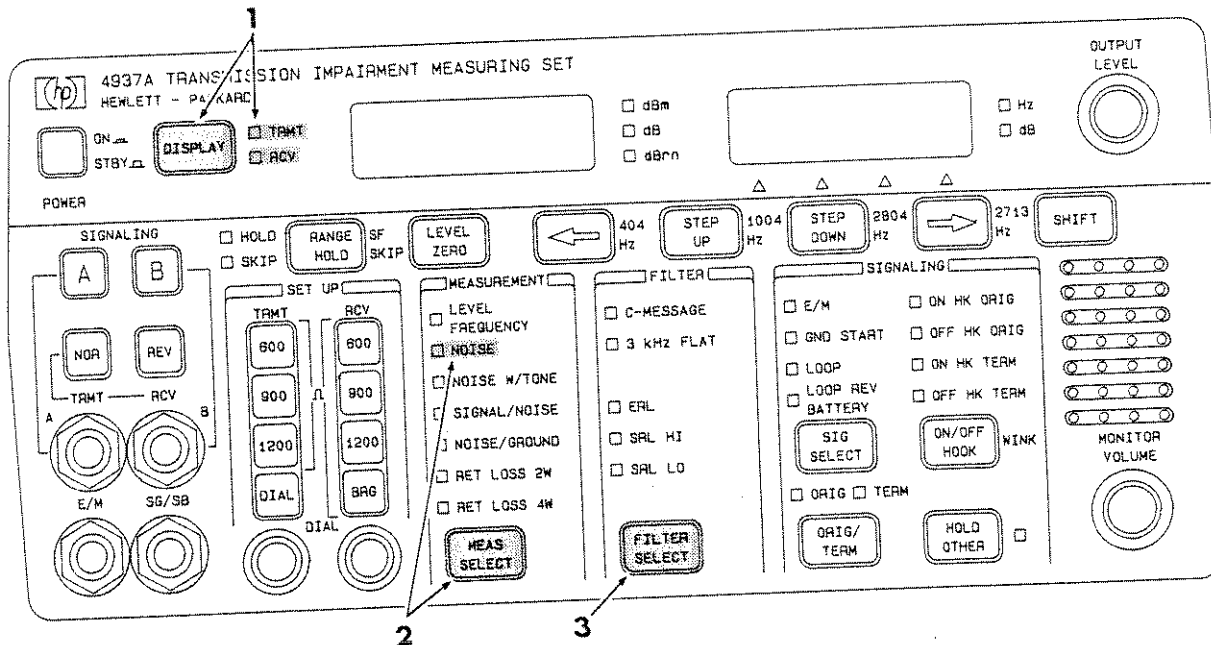

TRANSMITTER

1. Press DISPLAY-TRMT key to display the transmitted signal. TRMT indicator will light.
2. Press MEAS SELECT key to select NOISE.

Note

There will be no values displayed because in this configuration the transmitter is turned off and a quiet termination is supplied to the TRMT jack.

RECEIVER

1. Press DISPLAY-RCV key to display the received signal. RCV indicator will light.
2. Press MEAS SELECT key to select NOISE.
3. Press FILTER key and select the desired filter.
4. Read the dB_{rn} noise level in the left display. An Err 02 in the left display indicates underrange (<0 dB_{rn}).

NOISE WITH TONE

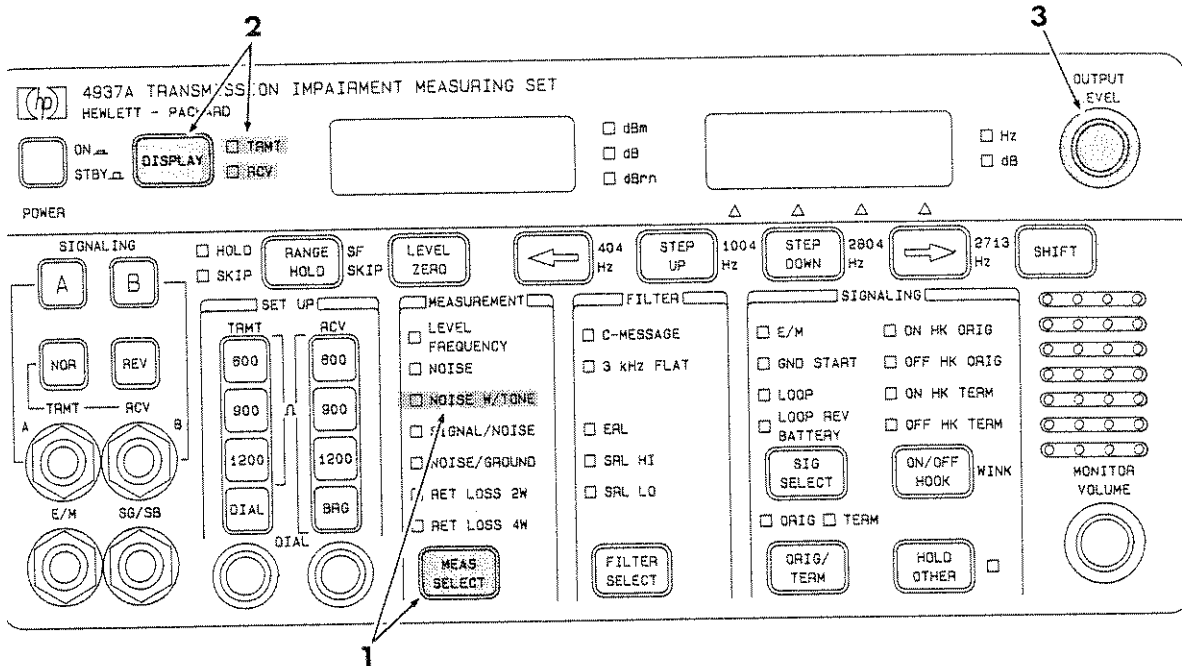

SMITTER

Press MEAS SELECT key to select NOISE W/TONE.

Press DISPLAY TRMT-RCV key to display the transmitted signal. TRMT indicator will be on and 1004 Hz will be in the right display.

Adjust OUTPUT LEVEL control to change 1004 Hz signal to data level in left display (usually 13 dB below the transmitted level point).

RECEIVER

Press MEAS SELECT key to select NOISE W/TONE.

Press DISPLAY TRMT-RCV key to display the received signal. RCV indicator will be on.

Read dBm in left display.

Note

Err 07 in right display indicates the received 1004 Hz tone has dropped below -46 dBm or exceeded +16 dBm.

3-47. SIGNAL TO NOISE

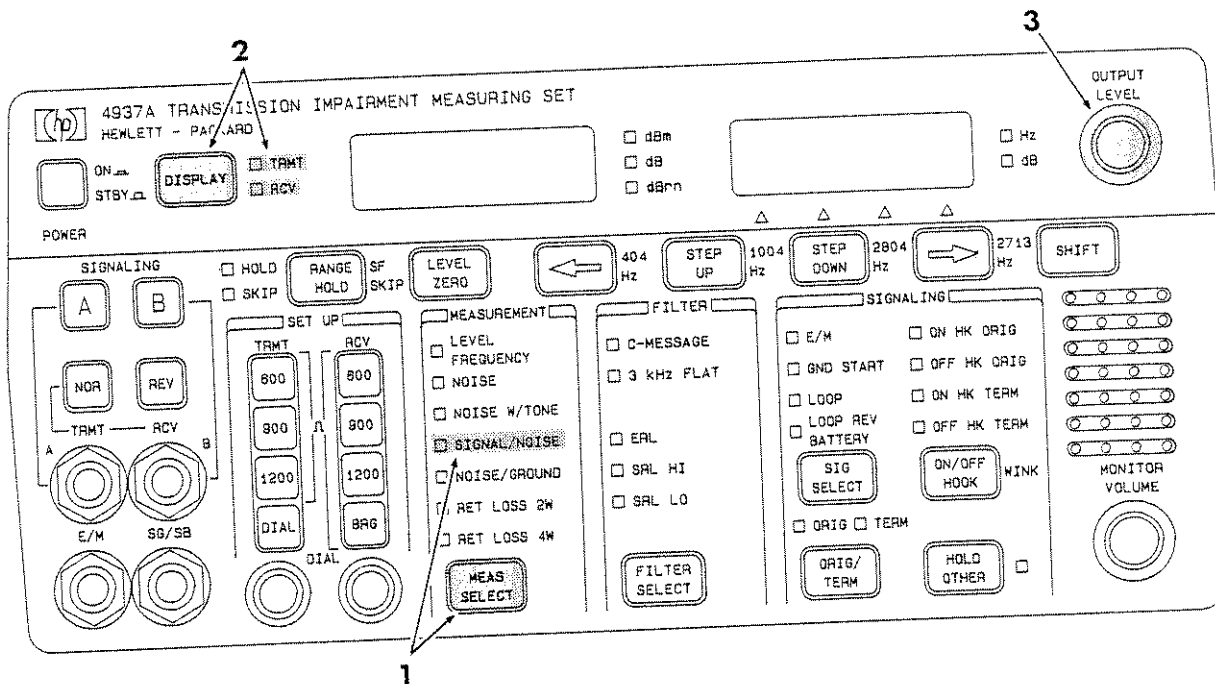

TRANSMITTER

1. Press MEAS SELECT key to select SIGNAL/NOISE.
2. Press DISPLAY-TRMT to display the transmitted signal. TRMT indicator will be on.
3. Adjust OUTPUT LEVEL control to change the 1004 Hz signal to data level (usually 13 dB below the transmitted level point).

RECEIVER

1. Press MEAS SELECT key to select SIGNAL/NOISE.
2. Press DISPLAY-RCV to display the received signal. RCV indicator will be on.
3. Read the signal to noise ratio as dB in the right display. The received level is displayed in the left display.

Note

Err 07 indicates the received 1004 Hz tone has dropped below -46 dBm or exceeded +16 dBm.

3. NOISE TO GROUND

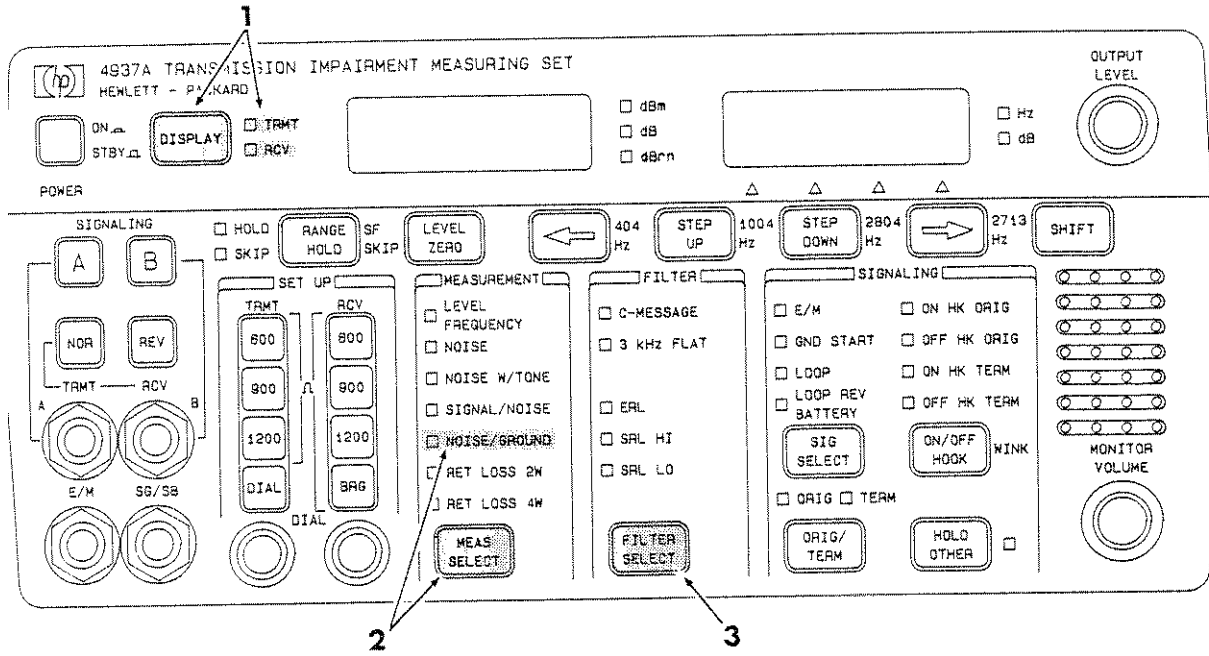

TRANSMITTER

Press DISPLAY-TRMT key to display the transmitted signal. TRMT indicator will be on.

Press MEAS SELECT key to select NOISE/GROUND. This provides a quiet termination to the TRMT jack.

Note

There will be no values displayed because in this configuration the transmitter is turned off and a quiet termination is supplied to the TRMT jack.

RECEIVER

Note

For valid noise to ground measurements the test set must be properly grounded. Connect the rear panel chassis ground post to a known ground.

Press DISPLAY-RCV key to display the received signal. RCV indicator will be on.

Press MEAS SELECT key to select NOISE/GROUND.

Use FILTER SELECT key to select the desired filter.

Read dBm noise level in the left display.

3-49. RETURN LOSS 2-WIRE

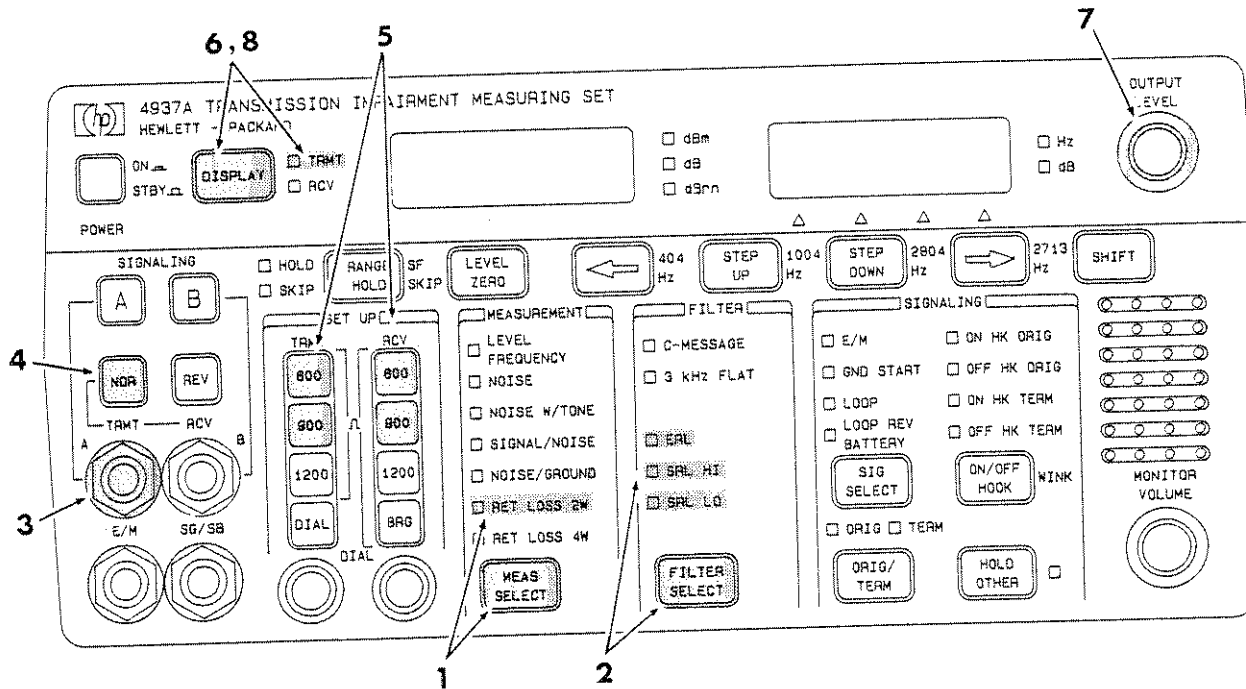

1. Press MEAS SELECT key to select RET LOSS 2W.
2. Press FILTER SELECT key to select one of the following:
 - ERL (echo return loss--middle band).
 - SRL HI (singing return loss--upper band).
 - SRL LO (singing return loss--lower band).
3. Connect the line under test to the A 310-jack.
4. Press NOR key.
5. Select TRMT and RCV impedance of either 600 or 900 ohms (600 ohms for Option 002). Return loss cannot be measured at 1200 ohms.
6. Press DISPLAY to select TRMT mode.

Note

The HP 4937A must be in the transmit mode before adjusting the output level.

1937A
LOSS

RETURN LOSS 2-WIRE (con't)

OUTPUT LEVEL control adjust the transmit level to desired level.

DISPLAY key to view results. Return loss is shown in dB on the left display.

FILTER SELECT key select the remaining test as listed in step 2.

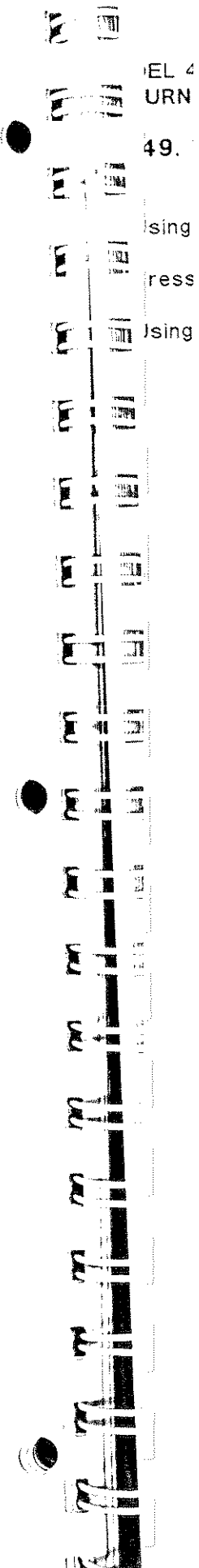

3-50. RETURN LOSS 4-WIRE

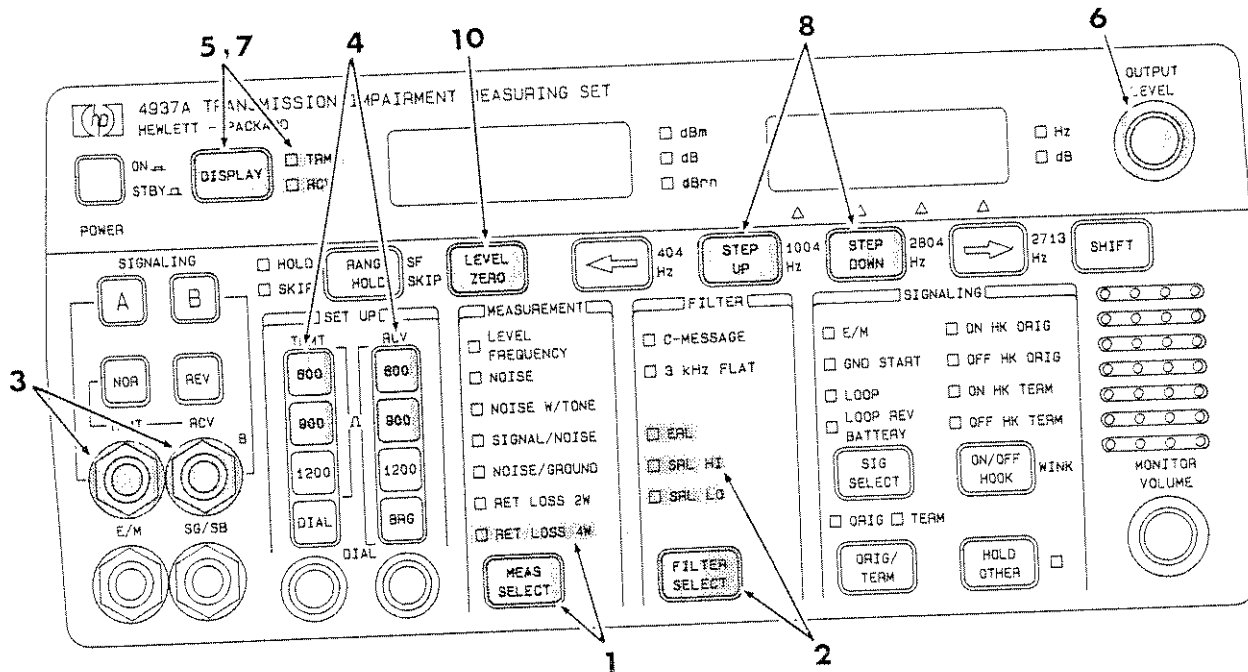

1. Press MEAS SELECT key to select RET LOSS 4W.
2. Press FILTER SELECT key to select one of the following:
 - ERL (echo return loss--middle band).
 - SRL HI (singing return loss--upper band).
 - SRL LO (singing return loss--lower band).
3. Connect the 4-wire circuit to the transmit and receive jacks.
4. Select TRMT and RCV impedance of either 600 or 900 ohms (600 ohms for Option 002). Return loss cannot be measured at 1200 ohms.
5. Press DISPLAY key to select TRMT mode.

Note

The HP 4937A must be in the transmit mode before adjusting the output level.

6. Using OUTPUT LEVEL control adjust the transmit level to desired level.
7. Press DISPLAY key to select RCV mode.

Free Manuals Download Website

<http://myh66.com>

<http://usermanuals.us>

<http://www.somanuals.com>

<http://www.4manuals.cc>

<http://www.manual-lib.com>

<http://www.404manual.com>

<http://www.luxmanual.com>

<http://aubethermostatmanual.com>

Golf course search by state

<http://golfingnear.com>

Email search by domain

<http://emailbydomain.com>

Auto manuals search

<http://auto.somanuals.com>

TV manuals search

<http://tv.somanuals.com>